

**SUN2000-(8KTL-20KTL)-M2**

# **Quick Guide**

**Issue: 03**

**Part Number: 31500BCA**

**Date: 2020-07-10**

**HUAWEI TECHNOLOGIES CO., LTD.**



## NOTICE

1. The information in this document is subject to change due to version upgrades or other reasons. Every effort has been made in the preparation of this document to ensure accuracy of the contents, but all statements, information, and recommendations in this document do not constitute a warranty of any kind, express or implied. You can download this document by scanning the QR code.
2. Before installing the device, read the user manual carefully to get familiar with product information and safety precautions.
3. Only qualified and trained electrical technicians are allowed to operate the device. Operation personnel should understand the composition and working principles of the grid-tied PV power system and local regulations.
4. Before installing the device, check that the package contents are intact and complete against the packing list. If any damage is found or any component is missing, contact your dealer.
5. Use insulating tools when installing the device. For personal safety, wear proper personal protective equipment (PPE).
6. Huawei shall not be liable for any consequences caused by the violation of the storage, transportation, installation, and operation regulations specified in this document and the user manual.

## 1 Product Description

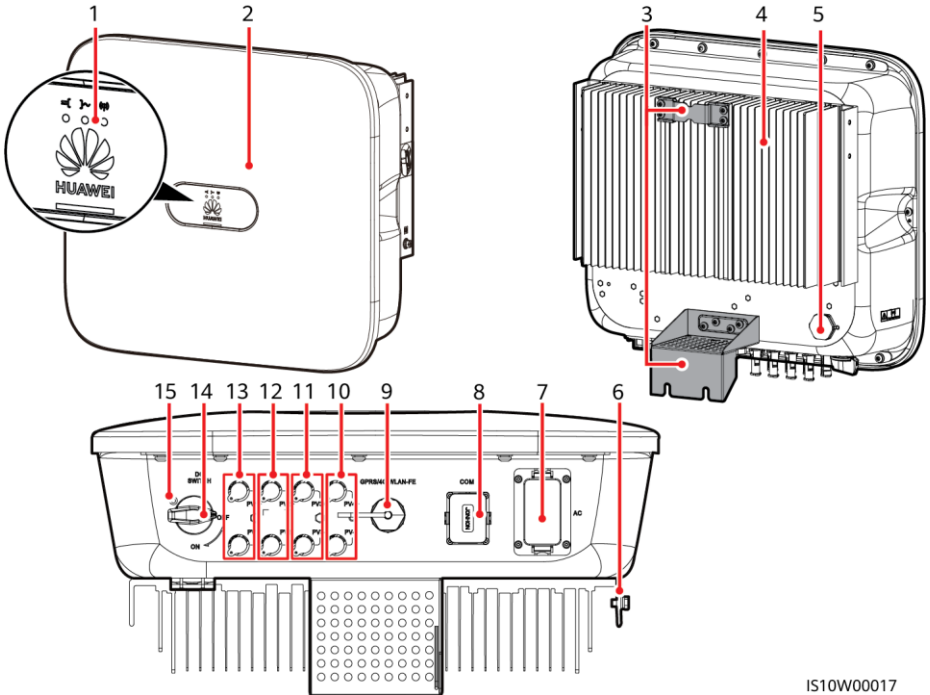

IS10W00017

- |  |                                     |
|--|-------------------------------------|
| (1) LED  | (2) Front panel                     |
| (3) Hanging kit  | (4) Heat sink                       |
| (5) Ventilation valve                                  | (6) Ground screw                    |
| (7) AC output port (AC)                                | (8) Communications port (COM)       |
| (9) Smart Dongle port (GPRS/4G/WLAN-FE)                | (10) DC input terminals (PV4+/PV4-) |
| (11) DC input terminals (PV3+/PV3-)                    | (12) DC input terminals (PV2+/PV2-) |
| (13) DC input terminals (PV1+/PV1-)                    | (14) DC switch (DC SWITCH)          |
| (15) Screw hole for the DC switch (for Australia only) |                                     |

## 2 Installing the Equipment

### 2.1 Installation Requirements

#### Angle

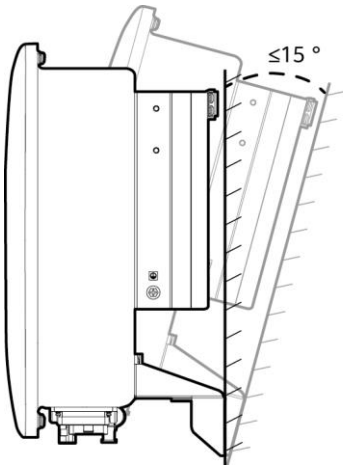

#### Space

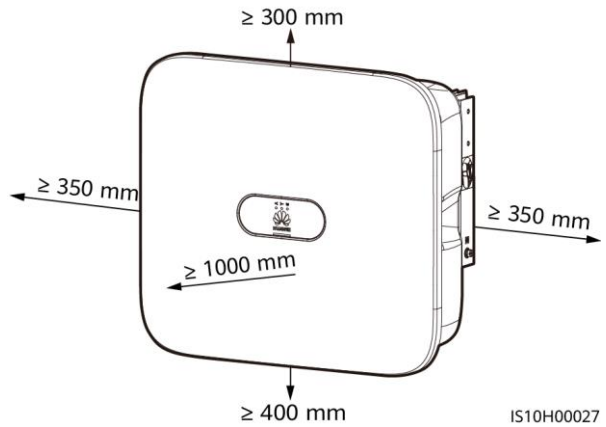

#### Dimensions

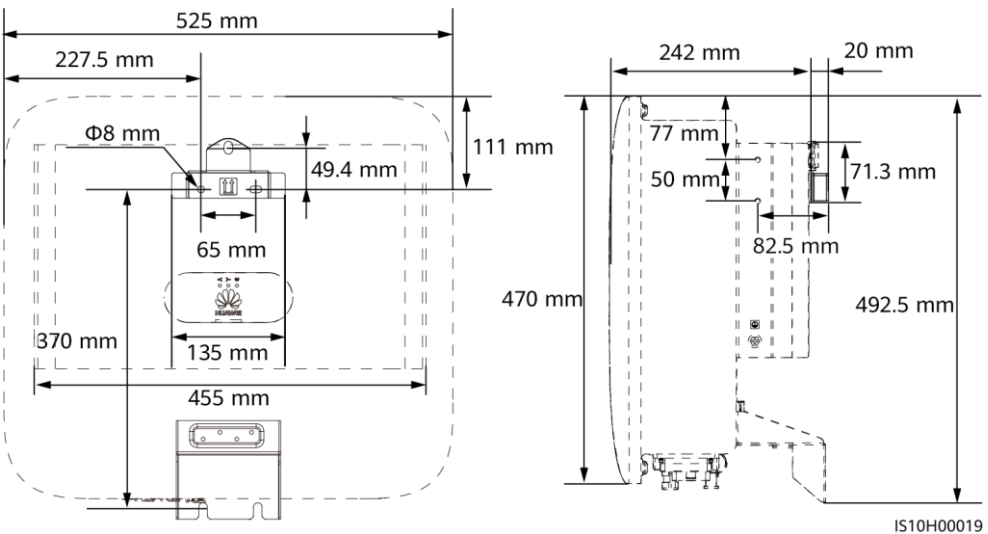

#### NOTE

Two M6 screw holes are reserved on both left and right sides of the inverter for installing an awning.

## 2.2 Installing the Inverter

### Moving an Inverter

#### DANGER

When drilling holes, avoid the water pipes and power cables buried in the wall.

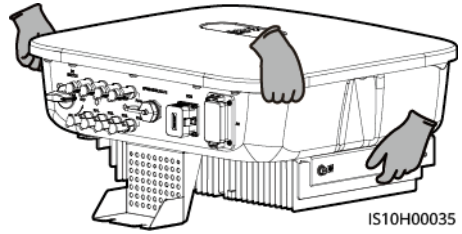

1. Install the mounting bracket.

#### NOTE

- M6x60 expansion bolts are delivered with the inverter. If the length and number of the bolts do not meet installation requirements, prepare M6 stainless steel expansion bolts by yourself.
- The expansion bolts delivered with the inverter are used for solid concrete walls. For other types of walls, prepare bolts by yourself and ensure that the wall meets the load bearing requirements of the inverter.
- Loosen the nuts, flat washers, and spring washers of the two expansion bolts.

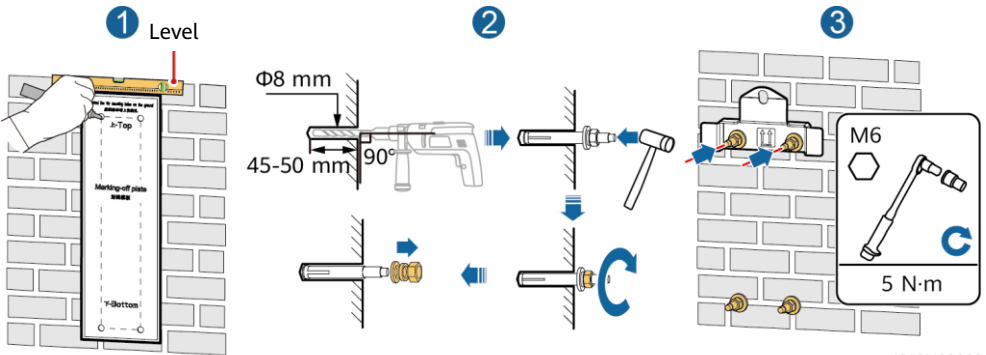

2. (Optional) Install the screw for locking the DC switch.

#### NOTE

- The screws for DC switches are delivered with solar inverters. According to Australian standards, the screws are used to secure DC switches (DC SWITCH) to prevent them from being turned on by mistake.
- For the model used in Australia, perform this step to meet the local standards.

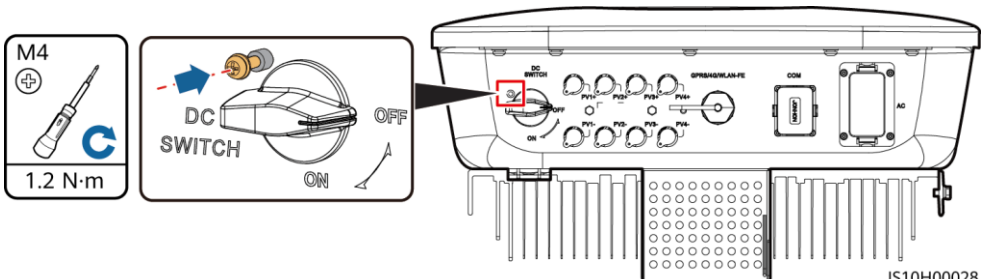

3. Install the inverter on the mounting bracket.

4. (Optional) Install an anti-theft lock.

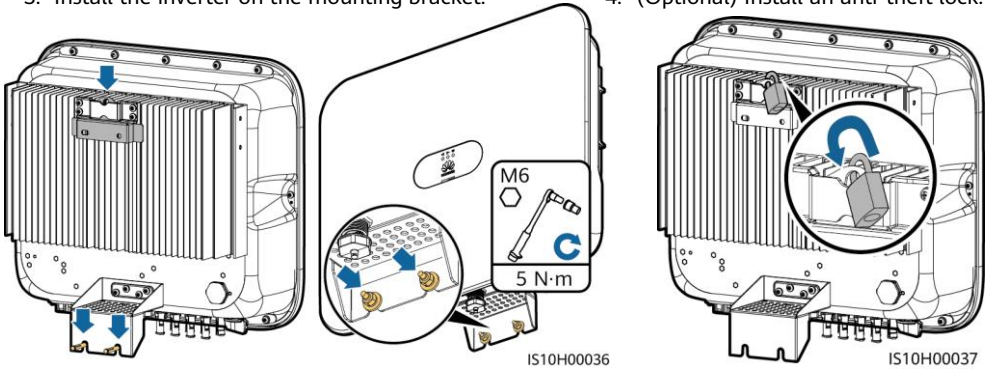

**NOTE**

Prepare an anti-theft lock suitable for the lock hole diameter ( $\Phi 8$  mm) and ensure that the lock can be installed successfully. An outdoor waterproof lock is recommended.

## 3 Electrical Connections

### 3.1 Preparing for Installation

**NOTICE**

- Connect cables in accordance with the local installation laws and regulations.
- Before connecting cables, ensure that the DC switch on the inverter and all the switches connecting to the inverter are set to OFF. Otherwise, the high voltage of the inverter may result in electric shocks.

No.	Item	Type	Specifications
1	PE cable	Single-core outdoor copper cable	Conductor cross-sectional area: <ul style="list-style-type: none"> <li>• <math>\geq 6 \text{ mm}^2</math> (SUN2000-8KTL-M2/SUN2000-10KTL-M2/SUN2000-12KTL-M2)</li> <li>• <math>\geq 10 \text{ mm}^2</math> (SUN2000-15KTL-M2/SUN2000-17KTL-M2/SUN2000-20KTL-M2)</li> </ul>
2	AC output power cable	Outdoor copper cable	Conductor cross-sectional area: <ul style="list-style-type: none"> <li>• <math>6\text{--}16 \text{ mm}^2</math> (SUN2000-8KTL-M2/SUN2000-10KTL-M2/SUN2000-12KTL-M2)</li> <li>• <math>10\text{--}16 \text{ mm}^2</math> (SUN2000-15KTL-M2/SUN2000-17KTL-M2/SUN2000-20KTL-M2)</li> </ul> Cable outer diameter: 11–26 mm
3	DC input power cable	Standard outdoor PV cable in the industry	<ul style="list-style-type: none"> <li>• Conductor cross-sectional area: <math>4\text{--}6 \text{ mm}^2</math></li> <li>• Cable outer diameter: 5.5–9 mm</li> </ul>
4	(Optional) RS485 communications cable	Two-core outdoor shielded twisted pair cable	<ul style="list-style-type: none"> <li>• Conductor cross-sectional area: <math>0.2\text{--}1 \text{ mm}^2</math> (<math>0.5 \text{ mm}^2</math> is recommended)</li> <li>• Cable outer diameter: 4–11 mm</li> </ul>
5	(Optional) RS485 power meter signal cable		
6	(Optional) Rapid shutdown switch signal cable		
7	(Optional) Grid scheduling signal cable		
		Five-core outdoor cable	

### 3.2 Installing the PE Cable

#### **DANGER**

Do not connect the neutral wire to the enclosure as a PE cable. Otherwise, electric shocks may occur.

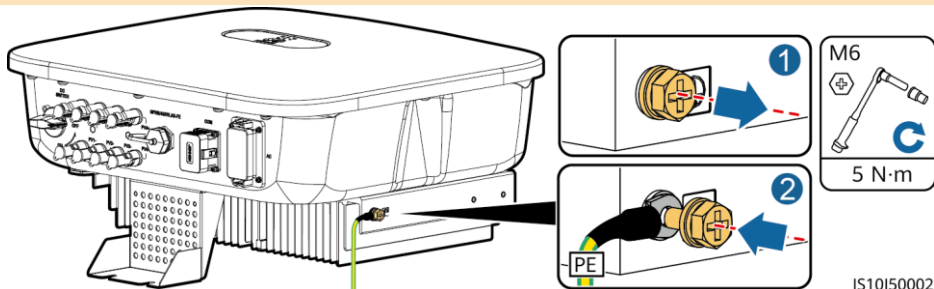

#### **NOTE**

- The PE point at the AC output port is used only as a PE equipotential point, and cannot substitute for the PE point on the enclosure.
- It is recommended that silica gel or paint be used around the ground terminal after the PE cable is connected.

### 3.3 Installing the AC Output Power Cable

#### **NOTICE**

- Ensure that the protection layer of the AC output power cable is inside the connector, the core wires are totally inserted into the cable hole, and the cable is connected securely. Failing to do so may cause device malfunction or damage.
- The hex key is delivered with the inverter and bound to the hanging kit at the bottom of the inverter.

1. Connect the AC output power cable to the AC connector.

#### **Hex key**

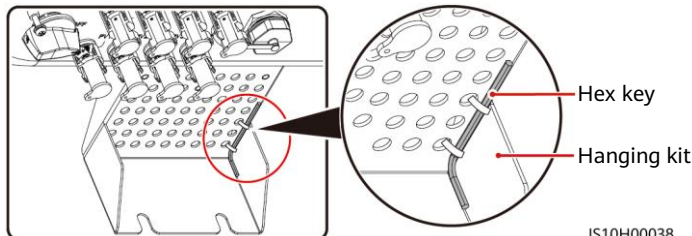

#### **Stripping requirements**

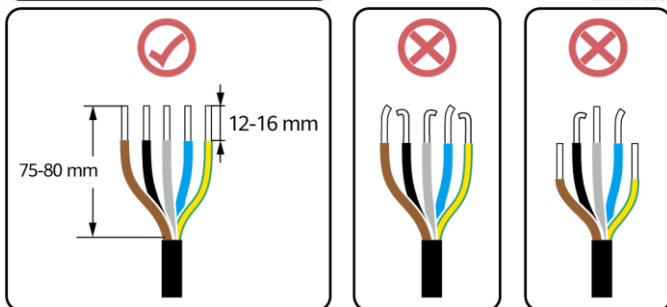

## Five-Core Cable (L1, L2, L3, N, and PE)

### NOTE

- This section describes how to connect a five-core AC output power cable to an AC connector.
- A three-core AC output power cable can be connected similarly. The three-core cable (L1, L2, and L3) is not connected to the neutral wire or PE wire.
- A four-core or five-core AC output power cable can be connected similarly. The four-core cable (L1, L2, L3, and PE) is not connected to the N wire, and the four-core cable (L1, L2, L3, and N) is not connected to the PE wire.

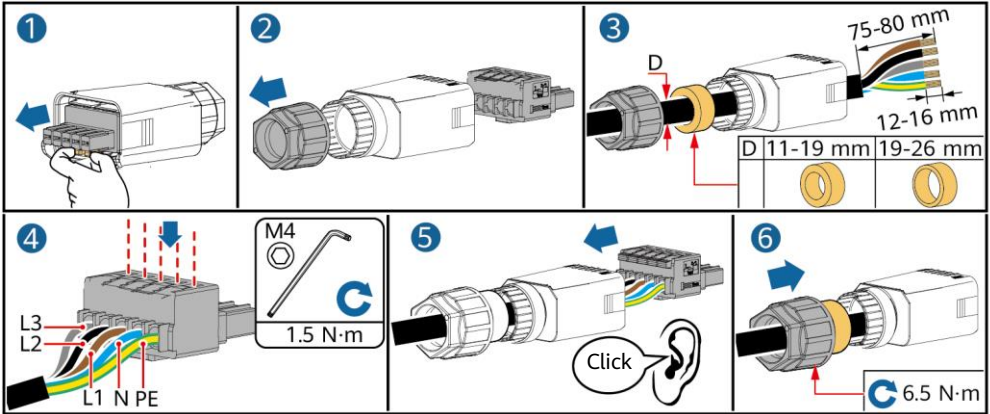

2. Connect the AC connector to the AC output port.

IS10I20013

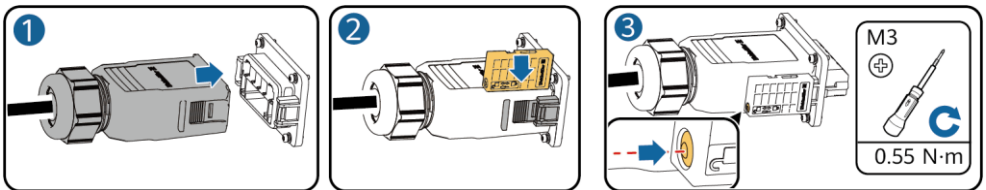
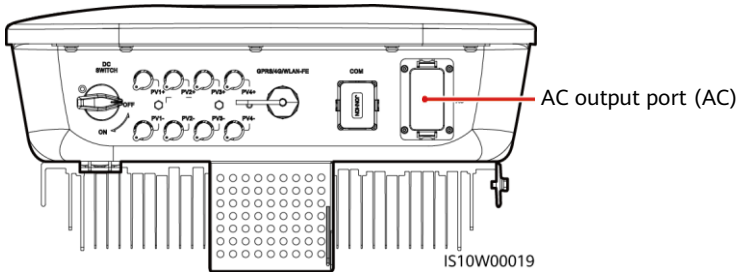

3. Check the route of the AC output power cable.

IS10H00029

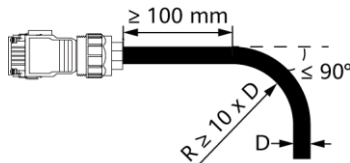

IS10I20017

## 3.4 Installing the DC Input Power Cable

### NOTICE

1. Ensure that the PV module output is well insulated to ground.
2. Use the Staubli MC4 positive and negative metal terminals and DC connectors supplied with the solar inverter. Using incompatible positive and negative metal terminals and DC connectors may result in serious consequences. The caused device damage is not covered under warranty.
3. The DC input voltage of the SUN2000 shall not exceed 1080 V DC under any circumstance.
4. Before installing the DC input power cable, label the cable polarities to ensure correct cable connections.
5. If the DC input power cable is reversely connected, do not operate the DC switch as well as positive and negative connectors immediately. Failing to do so may cause device damage, which is not covered under any warranty. Wait until the night when solar irradiance declines and the PV string current drops to below 0.5 A. Then set the DC switch to the OFF position, remove the positive and negative connectors, and correct the polarities of the DC input power cable.

1. Assemble DC connectors.

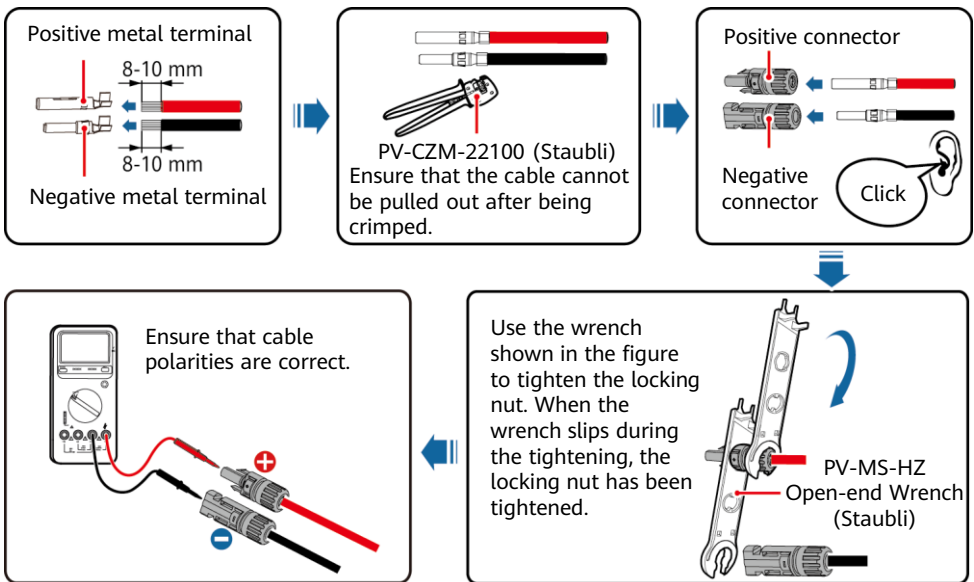

IH07130001

2. Connect DC input power cables.

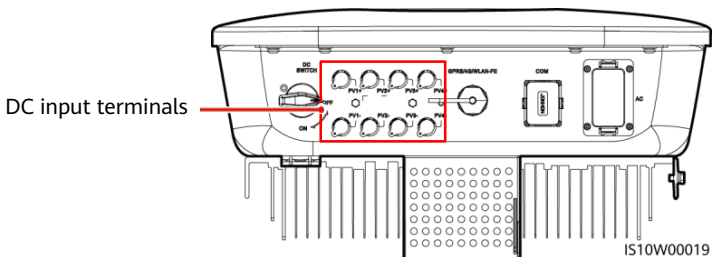



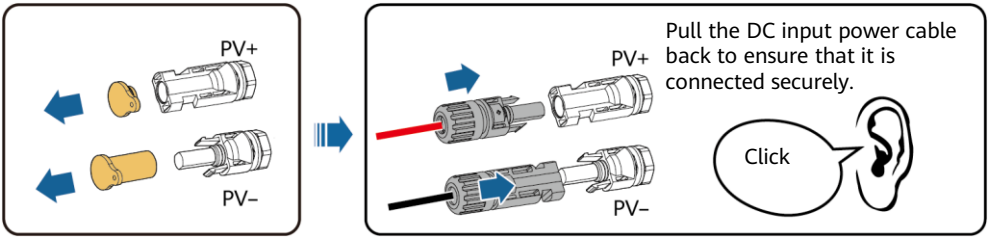

IH07130002

### 3.5 (Optional) Installing the Smart Dongle

**NOTE**

- If WLAN-FE communication is used, install a WLAN-FE Smart Dongle (SDongleA-05).
- If 4G communication is used, install a 4G Smart Dongle (SDongleA-03).
- You need to purchase the Smart Dongle by yourself.

Smart Dongle port (GPRS/4G/WLAN-FE)

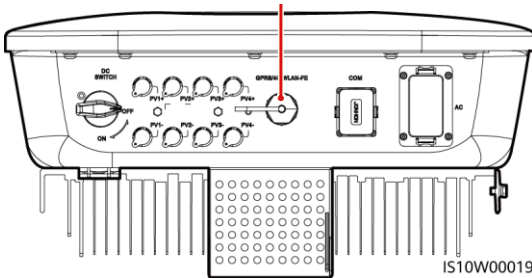

IS10W00019

#### WLAN-FE Smart Dongle (FE Communication)

You are advised to use a CAT 5E outdoor shielded network cable (outer diameter < 9 mm; internal resistance  $\leq 1.5 \Omega/10 \text{ m}$ ) and shielded RJ45 connectors.

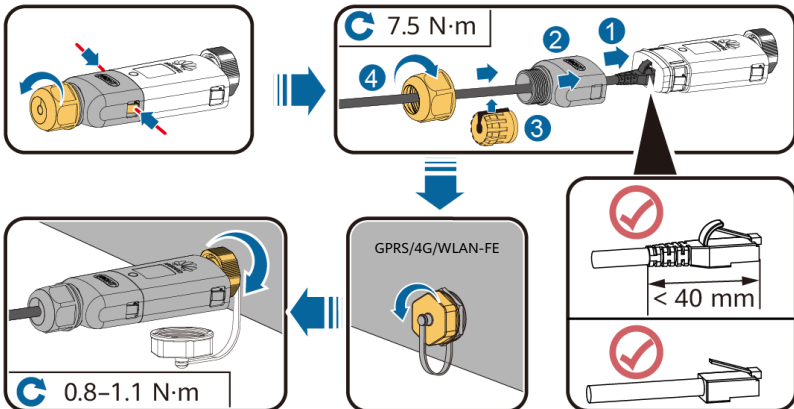

ILO4H00004

## 4G Smart Dongle (4G Communication)

### NOTICE

- If your Smart Dongle is not equipped with a SIM card, prepare a standard SIM card (size: 25 mm x 15 mm) with the capacity greater than or equal to 64 KB.
- Install the SIM card in the arrow direction.
- When reinstalling the cover of the Smart Dongle, ensure that the buckle springs back in place (you can hear a click).

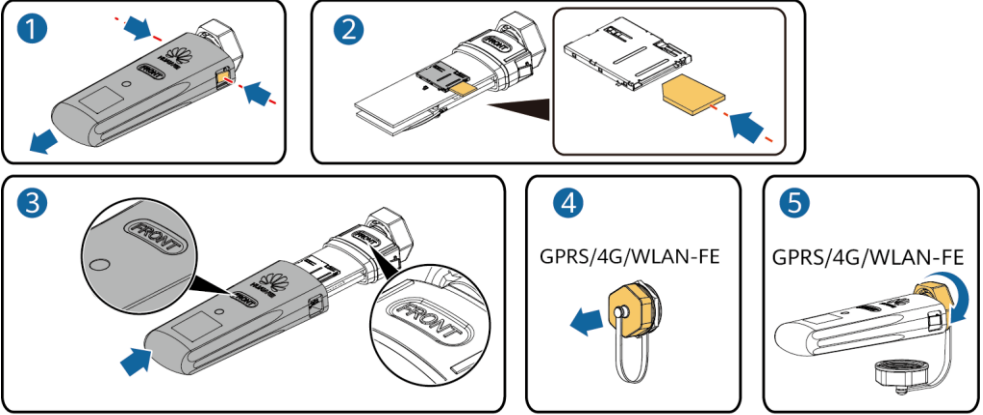

IS10H00016

### NOTE

- For details about how to operate the WLAN-FE Smart Dongle SDongleA-05, see *SDongleA-05 Quick Guide (WLAN-FE)*.
- For details about how to operate the 4G Smart Dongle SDongleA-03, see *SDongleA-03 Quick Guide (4G)*.
- The quick guide is delivered with the Smart Dongle. You can download them by scanning the QR code below.



WLAN-FE



4G

## 3.6 (Optional) Installing the Signal Cable

### NOTICE

- Not all inverter models are delivered with the signal cable connector.
- When laying out the signal cable, separate it from the power cable and keep it away from strong interference sources to avoid strong communication interference.
- Ensure that the protection layer of the cable is inside the connector, surplus core wires are cut off from the protection layer, the exposed core wire is totally inserted into the cable hole, and that the cable is connected securely.
- If the Smart Dongle is configured, you are advised to install the Smart Dongle before connecting the signal cable.

### Communications Port Pin Definition

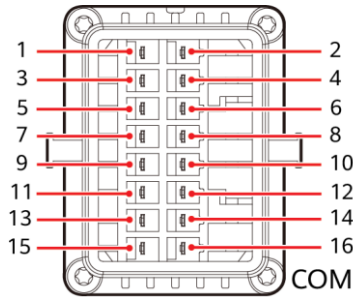

IS10W00002

Pin	Definition	Function	Description	Pin	Definition	Function	Description
1	485A1-1	RS485 differential signal+	Used to cascade inverters or connect to the RS485 signal port on the SmartLogger	2	485A1-2	RS485 differential signal+	Used to cascade inverters or connect to the RS485 signal port on the SmartLogger
3	485B1-1	RS485 differential signal-		4	485B1-2	RS485 differential signal-	
5	PE	Shielding ground	N/A	6	PE	Shielding ground	N/A
7	485A2	RS485 differential signal+	Used to connect to an RS485 signal port on a Smart Power Sensor for export limitation	8	DIN1	Dry contact interface for grid scheduling	Connect to ripple control receiver. For details, see the user manual.
9	485B2	RS485 differential signal-		10	DIN2		
11	N/A	N/A	N/A	12	DIN3		
13	GND	GND	Used to connect to the rapid shutdown DI signal port or served as a reserved port for the signal cable of the NS protection.	14	DIN4		
15	DIN5	Rapid shutdown signal+		16	GND		

## Smart Dongle Networking Scenario

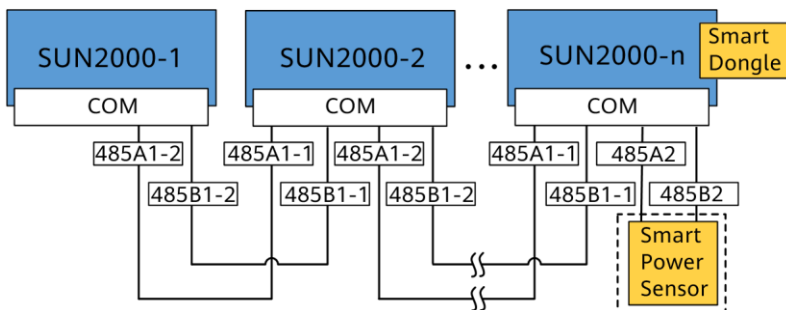

### NOTE

- In the Smart Dongle networking scenario, the SmartLogger cannot be connected.
- The Smart Power Sensor is necessary for export limitation. Only the DTSU666-H Smart Power Sensor (provided by Huawei) can be used.

## SmartLogger Networking Scenario

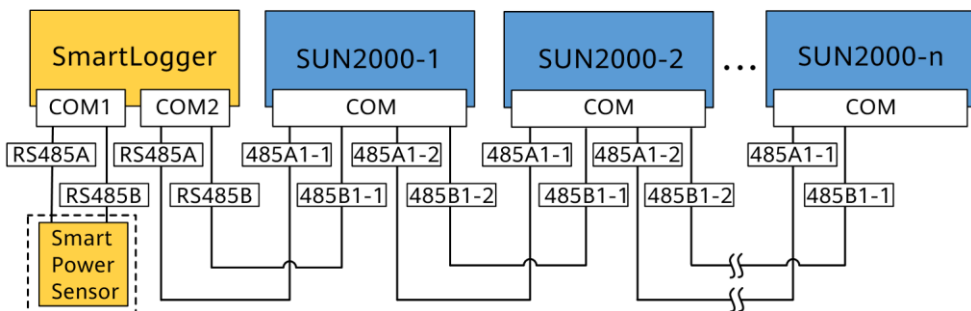

### NOTE

- In the SmartLogger networking scenario, the Smart Dongle cannot be connected.
- A maximum of 80 devices can connect to a single SmartLogger, such as inverters, Smart Power sensor, and EMI. You are advised to connect fewer than 30 devices to each RS485 route.
- The Smart Power Sensor is necessary for export limitation. Select the Smart Power Sensor according to the actual project.
- To ensure the system response speed, the Smart Power Sensor is recommended to be connected to a COM port separately from inverter COM port.

## (Optional) Installing the RS485 Communications Cable (Inverter Cascading)

1. Connect the signal cable to the signal cable connector.

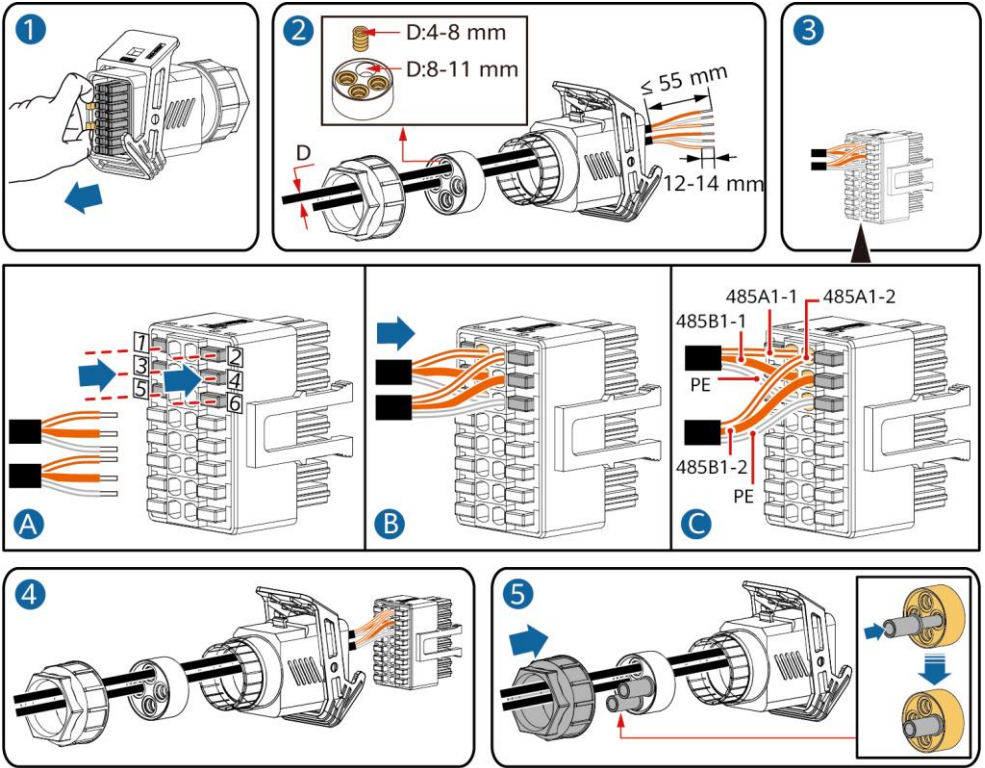

2. Connect the signal cable connector to the communication port.

IS10I20006

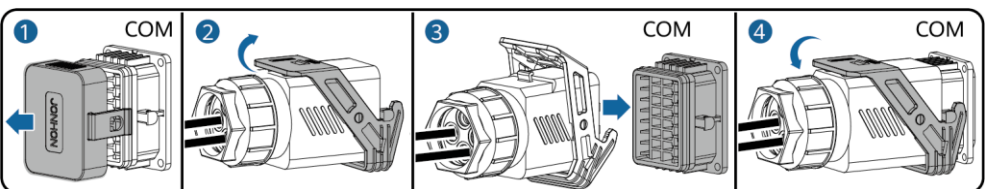
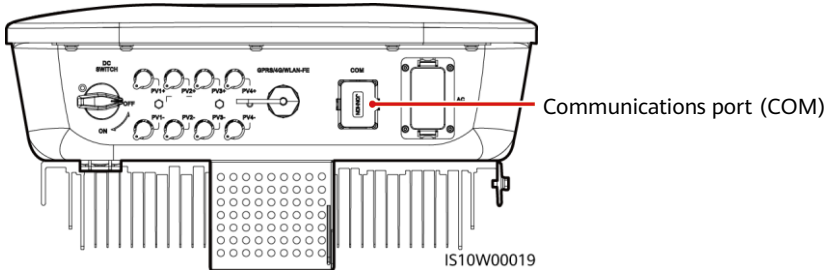

IS10I20007

## (Optional) Installing the Smart Power Sensor Signal Cable

1. Connect the signal cable to the signal cable connector.

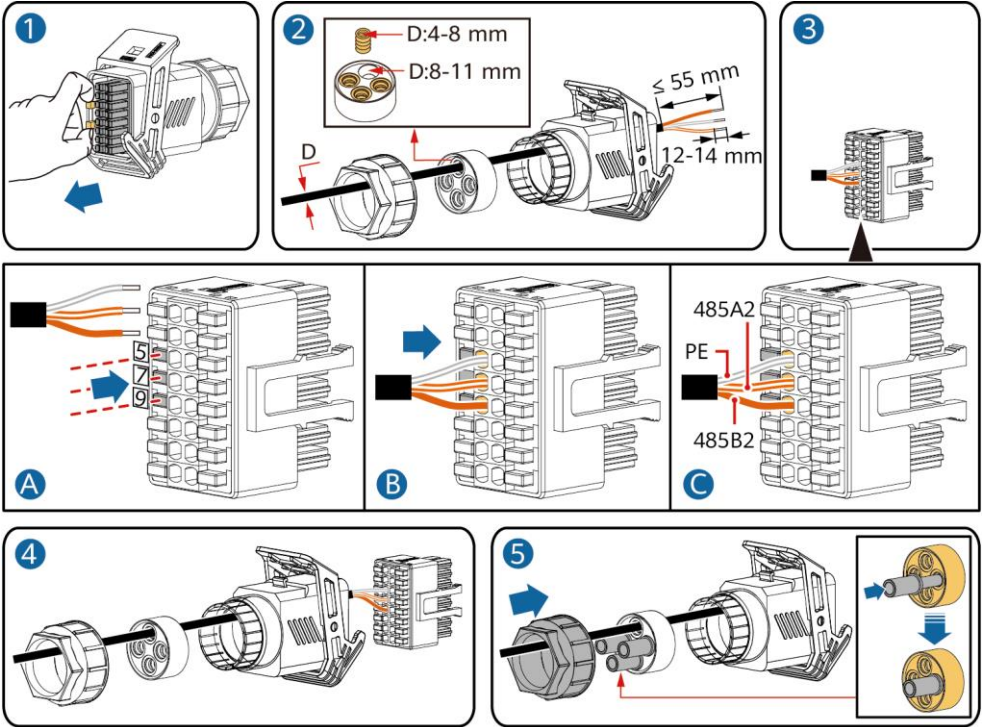

IS10I20008

2. Connect the signal cable connector to the communication port.

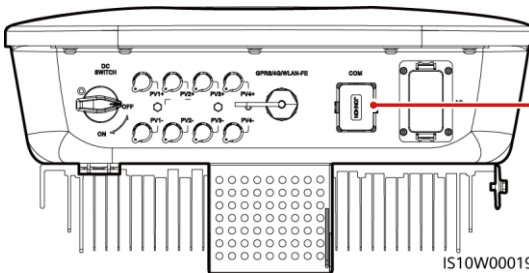

Communications port (COM)

IS10W00019

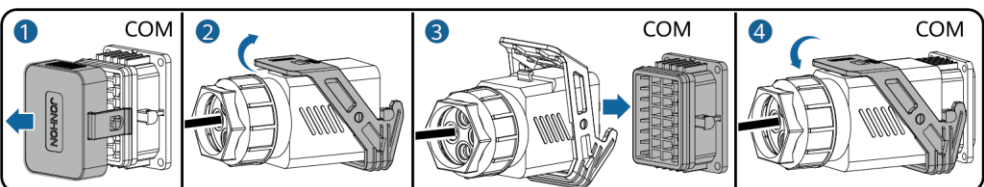

IS10I20007

## (Optional) Installing the Grid Scheduling Dry Contact Signal Cable

1. Connect the signal cable to the signal cable connector.

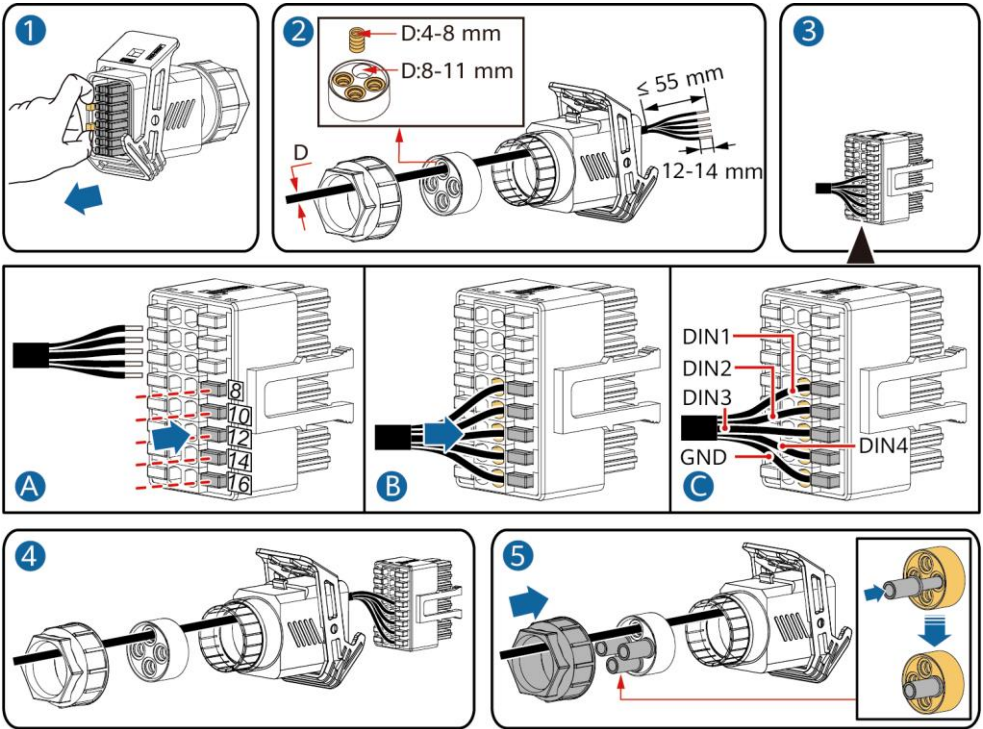

IS10I20010

2. Connect the signal cable connector to the Communication port.

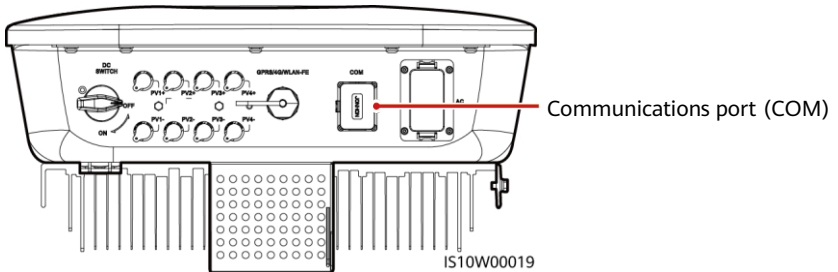

IS10W00019

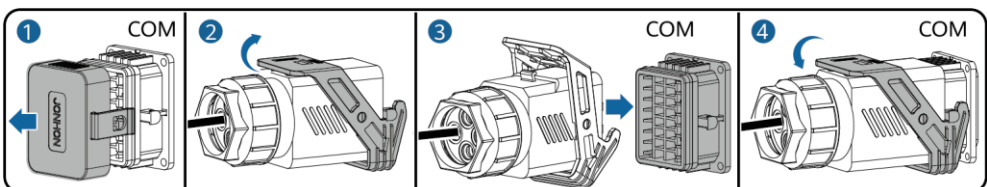

IS10I20007

## 4 Verifying Installation

No.	Acceptance Criteria
1	The inverter is installed correctly and securely.
2	Cables are routed properly as required by the customer.
3	The Smart Dongle is installed correctly and securely.
4	Cable ties are evenly distributed and no burr exists.
5	The PE cable is connected correctly, securely, and reliably.
6	The DC switch and all the switches connected to the inverter are set to the OFF position.
7	The AC output power cable, DC input power cable, and signal cable are connected correctly, securely, and reliably.
8	Unused terminals and ports are locked by watertight caps.
9	The installation space is proper, and the installation environment is clean and tidy.

## 5 Powering On the System

### NOTICE

Before turning on the AC switch between the inverter and the power grid, use a multimeter set to the AC position to check that the AC voltage is within the specified range.



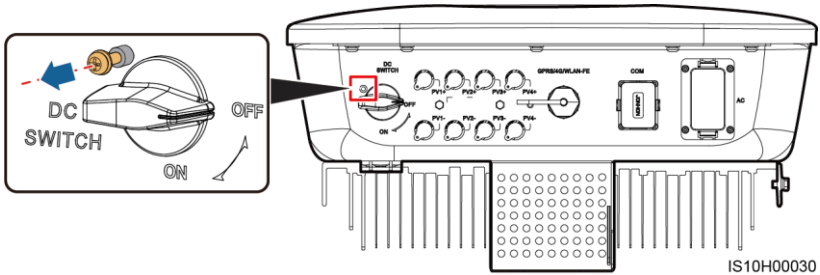



1. Turn on the AC switch between the inverter and the power grid.
2. (Optional) Remove the screw for locking the DC switch.



3. If there is a DC switch between the PV string and the inverter, turn on the DC switch.
4. Turn on the DC switch at the bottom of the inverter.



5. Observe the LEDs to check the operating status of the inverter.

Type	Status (Blinking at long intervals: On for 1s and then Off for 1s; Blinking at short Intervals: On for 0.2s and then Off for 0.2s)		Meaning	
Running indication			N/A	
	Steady green	Steady green	The solar inverter is operating in grid-tied mode.	
	Blinking green at long intervals	Off	The DC is on and the AC is off.	
	Blinking green at long intervals	Blinking green at long intervals	Both the DC and AC are on, and the solar inverter is not exporting power to the power grid.	
	Off	Blinking green at long intervals	The DC is off and the AC is on.	
	Off	Off	Both the DC and AC are off.	
	Blinking red at short intervals	N/A	There is a DC environmental alarm, such as an alarm indicating that High String Input Voltage, String Reverse Connection, or Low Insulation Resistance.	
	N/A	Blinking red at short intervals	There is an AC environmental alarm, such as an alarm indicating Grid Undervoltage, Grid Overvoltage, Grid Overfrequency, or Grid Underfrequency.	
	Steady red	Steady red	Fault.	
Communication indication			N/A	
	Blinking green at short intervals		Communication is in progress.	
	Blinking green at long intervals		A mobile phone is connected to the solar inverter.	
	Off		There is no communication.	
Device replacement indication				N/A
	Steady red	Steady red	Steady red	The solar inverter hardware is faulty. The solar inverter needs to be replaced.

6. (Optional) Observe the LED to check the operating status of the Smart Dongle.

### WLAN-FE Smart Dongle

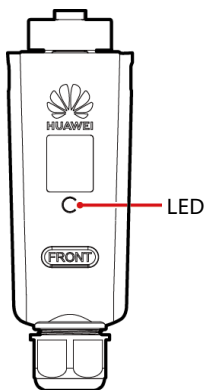

LED		Description
Color	Status	
Yellow (blinking green and red simultaneously)	Steady on	The Dongle is secured and powered on.
Red	Blinking at short intervals (on for 0.2s and then off for 0.2s)	The parameters for connecting to the router are to be set.
Green	Blinking at long intervals (on for 0.5s and then off for 0.5s)	Connecting to the router
Green	Steady on	Successfully connected to the management system.
Green	Blinking at short intervals (on for 0.2s and then off for 0.2s)	The inverter is communicating with the management system through the Dongle.

### 4G Smart Dongle

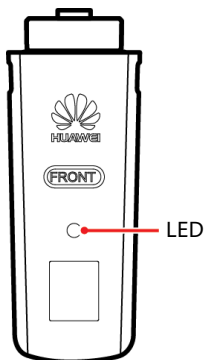

LED		Description
Color	Status	
Yellow (blinking green and red simultaneously)	Steady on	The Dongle is secured and powered on.
Green	Blinking in a 2-second cycle (on for 0.1s and then off for 1.9s)	Dialing (duration < 1 min)
Green	Blinking at long intervals (on for 1s and then off for 1s)	The dial-up connection is set up successfully (duration < 30s).
Green	Steady on	Successfully connected to the management system.
Green	Blinking at short intervals (on for 0.2s and then off for 0.2s)	The inverter is communicating with the management system through the Dongle.

# 6 Commissioning

## NOTE

- The screenshots are for reference only. The actual screens prevail.
- Obtain the initial password for connecting to the solar inverter WLAN from the label on the side of the solar inverter.
- To ensure account security, change the password periodically and keep the new password in mind. Not changing the password may cause password disclosure. A password left unchanged for a long period of time may be stolen or cracked. If a password is lost, devices cannot be accessed. In these cases, the user is liable for any loss caused to the PV plant.
- Before maintaining the optimizers and PV strings, turn off the AC switch and set the DC switch to OFF. Otherwise, the PV strings may be energized, resulting in electric shocks.

## 6.1 Downloading the App

Search for **FusionSolar** in Google Play or scan the corresponding QR code, download the latest installation package.



Google Play (Android)



FusionSolar (Android)



SUN2000 app

## NOTE

- In areas (such as the UK) where the FusionSolar app is not available, or when a third-party management system is used, only the SUN2000 app can be used for commissioning. This document uses the FusionSolar app as an example to describe the commissioning method. For the SUN2000 app, perform operations as required.
- Search for "SUN2000" in Huawei AppGallery, download the latest installation package, and install the SUN2000 app by following the instructions. The SUN2000 app version should be 3.2.00.005 (Android) or later.

## 6.2 (Optional) Registering an Installer Account

## NOTE

If you already have an installer account, skip this step.

Creating the first installer account will generate a domain named after the company.

The registration process consists of three main steps:

- Login Screen:** The user is prompted to log in. A red box highlights the "No Account?" link at the bottom left, with a hand icon pointing to it.
- Role Selection:** The user is asked to "Select your role". The "Installer role" option is highlighted with a red box and a hand icon pointing to it. The description for the installer role is: "Quick site deployment, plant O&M, and plant operation monitoring. Click here to create your account."
- Registration Form:** The user enters details for the installer account. A red box highlights the entire registration form, which includes fields for: Company Name, Email Address, User Name, Password, and Verification Code. A note at the top states: "Note: If your company has registered an account, you do not need to register the account again. Contact the administrator to add the registered account to the user list." A hand icon points to the "Registration" button at the bottom.

## NOTICE

To create multiple installer accounts for a company, log in to the FusionSolar app and tap **New User** to create an installer account.

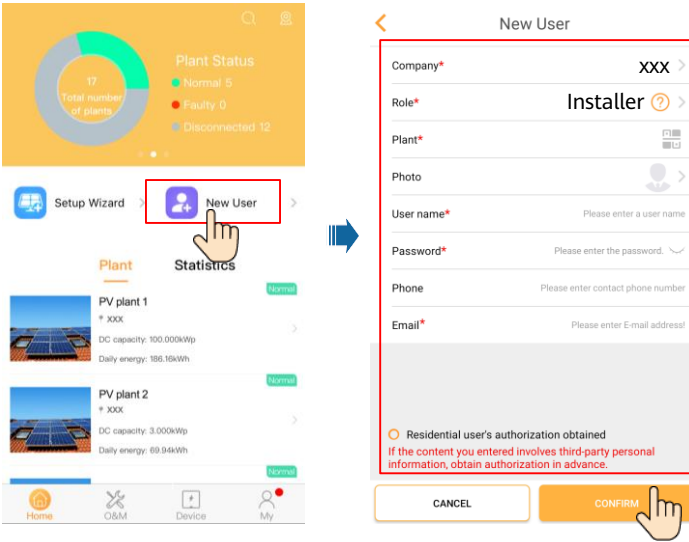

## 6.3 Creating a PV Plant and a Plant Owner

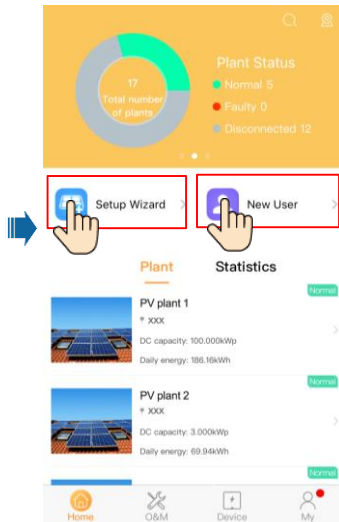
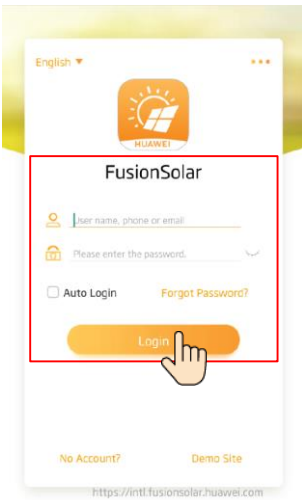

### NOTE

For details, see the *FusionSolar App Quick Guide*. You can scan the QR code to download the app.



## 6.4 Setting the Physical Layout of Smart PV Optimizers

### NOTE

- If Smart PV Optimizers are configured for PV strings, ensure that the Smart PV Optimizers have been successfully connected to the solar inverter before performing the operations in this section.
- The PV strings connecting to the same MPPT route should contain the same number and model of PV modules or Smart PV optimizers.
- Check that the SN labels of Smart PV Optimizers are correctly attached to the physical layout template.
- Take and save a photo of the physical layout template. Place the template on a flat surface. Keep your phone parallel to the template and take a photo in landscape mode. Ensure that the four positioning points in the corners are in the frame. Ensure that each QR code is attached within the frame.
- For details about the physical layout of Smart PV Optimizers, see *FusionSolar App Quick Guide*.

### Scenario 1: Setting on the FusionSolar Server Side (Solar Inverter Connected to the Management System)

1. Tap the plant name on the **Home** screen to access the plant screen. Select **Plant layout**, tap  and upload the physical layout template photo of the PV plant as prompted.

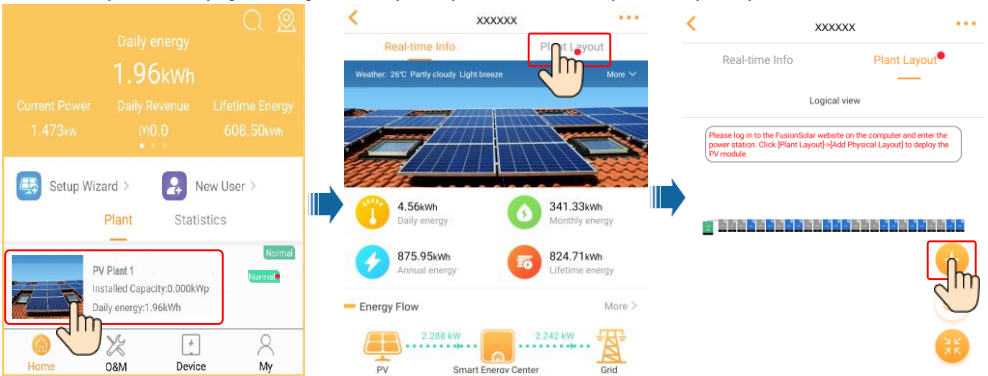

The image shows two screenshots from the FusionSolar app. The left screenshot is the Home screen, displaying 'Daily energy 1.96kWh', 'Current Power 1.473kw', and 'Daily Revenue 100.0'. Below this, there are buttons for 'Setup Wizard', 'New User', and 'Plant Statistics'. A red box highlights the 'PV Plant 1' card, which shows 'Installed Capacity: 0.000kWhp' and 'Daily energy: 1.96kWh'. A hand icon points to this card. The right screenshot is the Plant layout screen, showing 'Real-time info' with weather details and energy statistics. A red box highlights the 'Plant layout' button at the top, and another red box highlights a plus icon on the right side of the screen. A hand icon points to the plus icon. A message at the bottom of the right screenshot says: 'Please log in to the FusionSolar website on the computer and enter the power station. Click [Plant Layout]->Add Physical Layout) to deploy the PV module.'

2. Log in to <https://intl.fusionsolar.huawei.com> to access the WebUI of the FusionSolar Smart PV Management System. On the **Homepage** page, click the plant name to go to the plant page. Select **Plant layout**. Choose  > **Generate with AI**, and create a physical layout as prompted. You can also manually create a physical location layout.



The image shows two screenshots from the FusionSolar WebUI. The left screenshot is the Plant Overview page, displaying 'Plant KPIs' with four cards: 'Current Power (MW) 1.608', 'Daily Energy (MWh) 9.97', 'Daily Income (€) 1,670.2', and 'Lifetime Energy (GWh) 4.39'. Below this, there are fields for 'Plant name 2246', 'Region', and 'Device'. A table below shows 'Status' as 'Live View' and 'Plant Name' as '2246'. A hand icon points to the 'Live View' button. The right screenshot is the Physical Layout page, showing a 'View selection' dropdown with 'Logical Layout' and 'Add Physical Layout' options. A hand icon points to the 'Add Physical Layout' button. Below this, there are buttons for 'Physical Layout' and 'Generate with AI'. A hand icon points to the 'Generate with AI' button. A message at the bottom of the right screenshot says: 'You have not created a physical layout. Please create a physical layout first.' and 'Physical view sync to app is currently not supported.'

## NOTE

You can also upload the physical layout template photo on the WebUI as follows: Log in to <https://intl.fusionsolar.huawei.com> to access the WebUI of the FusionSolar Smart PV Management System. On the home page, click the plant name to go to the plant page. Choose **Plant layout**, click **Add Physical Layout** > (+), and upload the physical layout template photo.

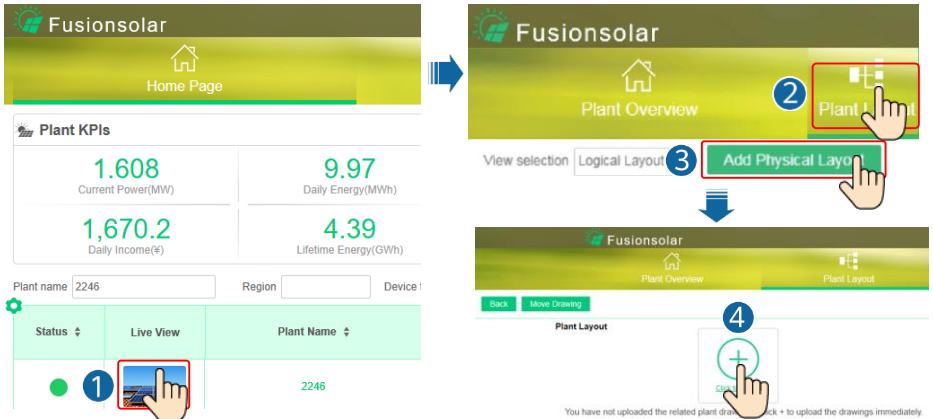

## Scenario 2: Setting on the Solar Inverter Side (Solar Inverter Not Connected to the Management System)

1. If the solar inverter is not connected to the FusionSolar Smart PV Management System, access the **Device commissioning** screen (Refer to 7.1 Device Commissioning.) on the FusionSolar app to set the physical layout of Smart PV Optimizers.
  - a. Log in to the FusionSolar app. On the **Device commissioning** screen, choose **Maintenance** > **Physical layout design of PV modules**. The **Physical layout design of PV modules** screen is displayed.
  - b. Tap the blank area. The **Identify image** and **Add PV modules** buttons are displayed. You can use either of the following methods to perform operations as prompted:
    - Method 1: Tap **Identify image** and upload the physical layout template photo to complete the optimizer layout. (The optimizers that fail to be identified need to be manually bound.)
    - Method 2: Tap **Add PV modules** to manually add PV modules and bind the optimizers to the PV modules.

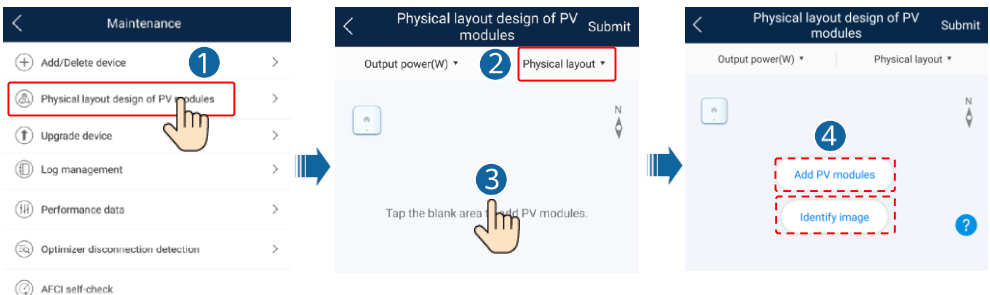

## NOTE

For details about the physical layout of optimizers on the FusionSolar app and FusionSolar WebUI, see the *FusionSolar App Quick Guide*. You can scan the QR code to download the app.



## 6.6 SmartLogger Networking Scenario

For details, see the *Distributed PV Plants Connecting to Huawei Hosting Cloud Quick Guide (Distributed Solar Inverters + SmartLogger1000A + RS485 Networking)* and *PV Plants Connecting to Huawei Hosting Cloud Quick Guide (Inverters + SmartLogger3000 + RS485 Networking)*. You can scan the QR codes to obtain the documents.



SmartLogger1000A



SmartLogger3000

## 7 FAQ

### 7.1 Device Commissioning

#### 1. Access Device commissioning.

Scenario 1: Your phone is not connected to the Internet.

Scenario 2: Your phone is connected to the Internet.

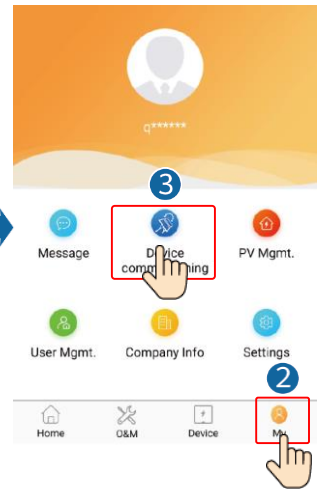
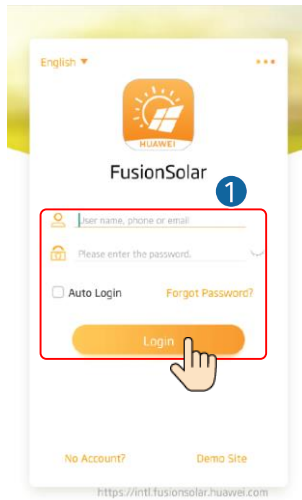
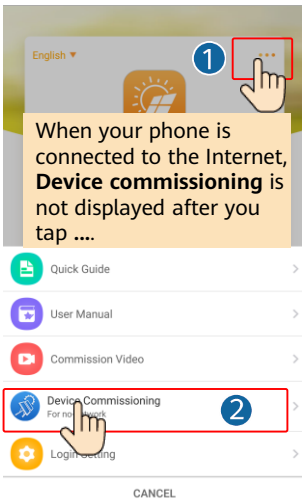

2. Connect to the solar inverter WLAN and log in as **installer** to access the device commissioning screen.

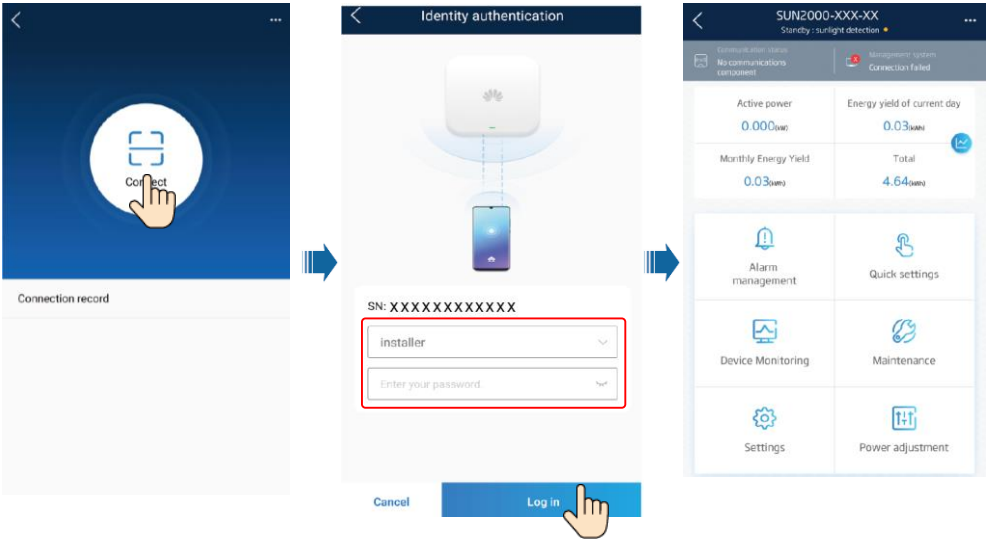

## 7.2 Resetting the Password

1. Ensure that the SUN2000 connects to the AC and DC power supplies at the same time. Indicators and are steady green or blink at long intervals for more than 3 minutes.
2. Perform the following operations within 3 minutes:
  - a. Turn off the AC switch and set the DC switch at the bottom of the SUN2000 to OFF. Wait until all the LED indicators on the SUN2000 panel turn off.
  - b. Turn on the AC switch and set the DC switch to ON. Ensure that the indicator is blinking green at long intervals.
  - c. Turn off the AC switch and set the DC switch to OFF. Wait until all LED indicators on the SUN2000 panel are off.
  - d. Turn on the AC switch and set the DC switch to ON.
3. Reset the password within 10 minutes. (If no operation is performed within 10 minutes, all inverter parameters remain unchanged.)
  - a. Wait until the indicator blinks green at long intervals.
  - b. Obtain the initial WLAN hotspot name (SSID) and initial password (PSW) from the label on the side of the SUN2000 and connect to the app.
  - c. On the login screen, set a new login password and log in to the app.
4. Set router and management system parameters to implement remote management



## 8 Customer Service Contact

Customer Service Contact			
Region	Country	Service Support Email	Phone
Europe	France	eu_inverter_support@huawei.com	0080033888888
	Germany		
	Spain		
	Italy		
	UK		
	Netherlands		
	Other countries		
Asia Pacific	Australia	au_inverter_support@huawei.com	1800046639
	Turkey	tr_inverter_support@huawei.com	N/A
	Malaysia	apsupport@huawei.com	0080021686868 /1800220036
	Thailand		(+66) 26542662 (charged by local call)
			1800290055 (free in Thailand)
	China	solarservice@huawei.com	4008229999
	Other countries	apsupport@huawei.com	0060-3-21686868
Japan	Japan	Japan_ESC@ms.huawei.com	0120258367
India	India	indiaenterprise_TAC@huawei.com	1800 103 8009
South Korea	South Korea	Japan_ESC@ms.huawei.com	N/A
North America	USA	na_inverter_support@huawei.com	1-877-948-2934
	Canada	na_inverter_support@huawei.com	1-855-482-9343
Latin America	Mexico	la_inverter_support@huawei.com	018007703456 /0052-442-4288288
	Argentina		0-8009993456
	Brazil		0-8005953456
	Chile		800201866 (only for fixed)
	Other countries		0052-442-4288288
Middle East and Africa	Egypt	mea_inverter_support@huawei.com	08002229000 /0020235353900
	UAE		08002229000
	South Africa		0800222900
	Saudi Arabia		8001161177
	Pakistan		0092512800019
	Morocco		0800009900
	Other countries		0020235353900

**Huawei Technologies Co., Ltd.**  
Huawei Industrial Base, Bantian, Longgang  
Shenzhen 518129 People's Republic of China  
[solar.huawei.com](http://solar.huawei.com)