



iOS



Android



BH QUICK INSTALLATION INSTRUCTIONS

PART 1

QUICK
INSTALLATION

PART 2

BATTERY
CONNECTION

PART 3

Wi-Fi
CONFIGURATION



Step 1. Instructions For Quick Installation

A Installation Space

Upward -----300mm
 Downward -----500mm
 Front -----300mm
 Left and right side -----200mm

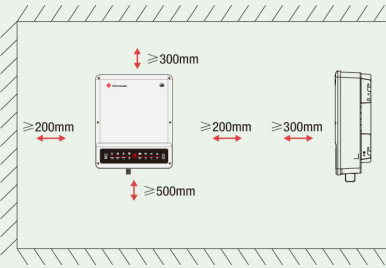

B Dimensions For Drilling Holes

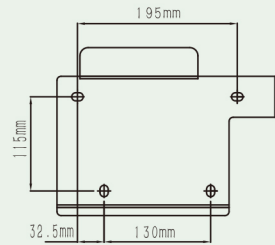

C Fix the Wall Bracket

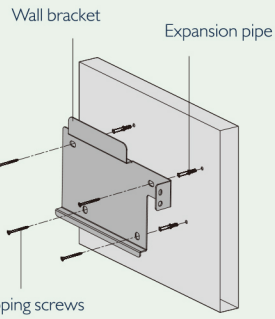

D Installation

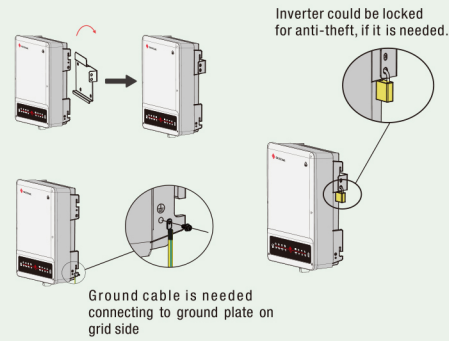

E Battery wiring assembly and connection

Grade	Description	Value
A	Out side Diameter	5.5-8.0mm
B	Conduct Wire Length	7mm
C	Conduct Core Section	4-6 mm ²

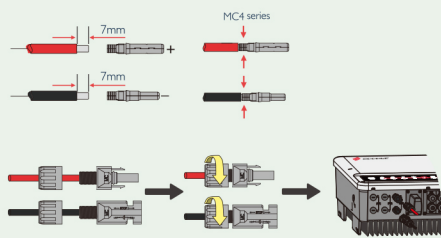

F On-grid wiring assembly and connection

Grade	Description	Value
A	Out side Diameter	13-22mm
B	Separated Wire Length	10-15mm
C	Conduct Wire Length	12-14mm
D	Conduct Core Section	8-10 mm ²

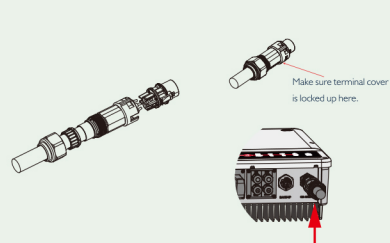

G Back-Up wiring connection process is as below

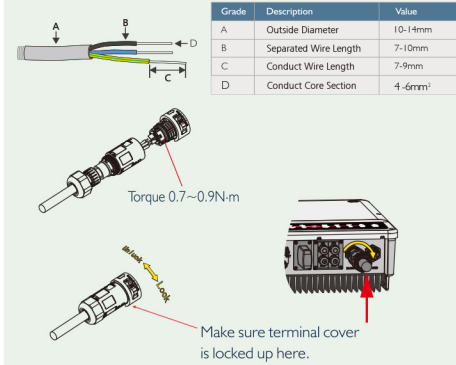

H Communication Cable Connection

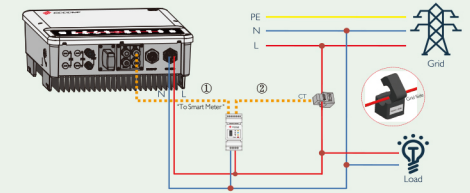

I DRED Cable Assembly

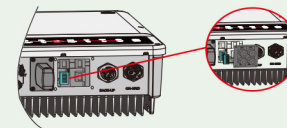
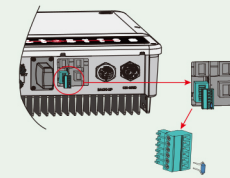

For DRED function wiring connection

⚠ DRED connection is only available for Australia and New Zealand.

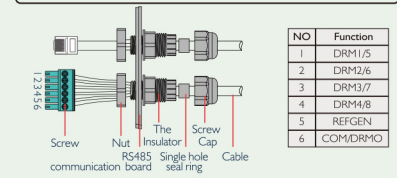

For Remote Shutdown function wiring connection

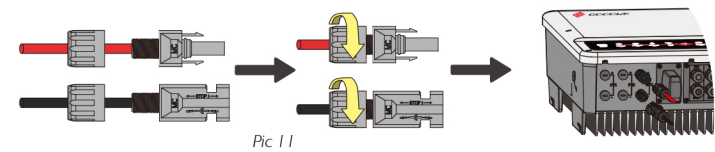
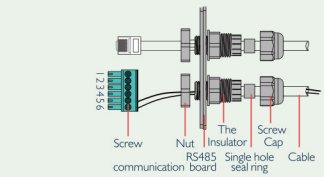

Step 2. SOP of Battery Connection With BH Inverter

BYD



Pylon

Note: This manual only tells connection methods between battery and Goodwe BH inverters. Other operation on battery, please refer to battery user manual. (This Quick Reference only includes parts of batteries, if there is a subsequent increase in battery, there will be no further notice.)

1. BYD B-BOX



For BYD Battery-Box H 6.4/7.9/9.0/10.2 with inverter.

A  Make sure that the converter and the battery pack is turned off before connecting the battery pack to the converter (Refer to Pic.1)



Pic.1

B To connect the cables coming from the inverter to the BYD battery pack, take the following steps.
Connect the power cables to the terminal block of BYD battery management unit(BMU).
Connect the positive cable to "P+" and the negative cable to "P-"
(Refer to Pic.2)



Pic.2

C Connect the other end of the power cable to the terminal block of the hybrid inverter.(Pic.3)



Pic.3

D The communication cable for battery is attached on the converter. Please use this cable as battery communication cable. (Refer to Pic.4)

Pic.4

E The other end of "To Battery" cable should be connected to CAN port of BYD BMU box. Before this, you should pick out the blue and white line and the blue line. Then, connect the blue and white line to the second hole site, and connect the blue line to the third hole site.(Pic.5)

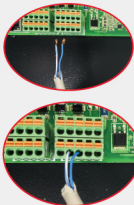
Pic.5

F On PV Master, you should choose the right battery type used in your system by "Select Battery Model" selection or battery communication will fail.(Pic.6)

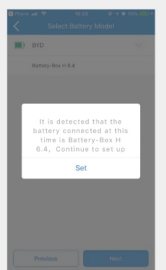

Pic.6

G After all connections and settings are done, please check if battery communication is OK on PV Master → Param → BMS status, which should be "Communication OK".(Pic.7)

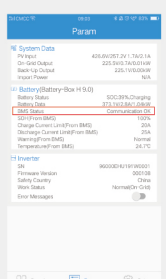

Pic.7

• WIRING SYSTEM FOR BH SERIES INVERTER

Please select Breaker according to the specification below

GW3K-BH	①	50A/230V AC breaker	②	32A/230V AC breaker	④	Depends on household loads
GW3600-BH	①	40A/600V DC breaker	②	50A/230V AC breaker	③	32A/230V AC breaker
GW5000-BH	①	63A/230V AC breaker	②	63A/230V AC breaker	③	32A/230V AC breaker
GW6000-BH	①	63A/230V AC breaker	②	63A/230V AC breaker	③	40A/230V AC breaker

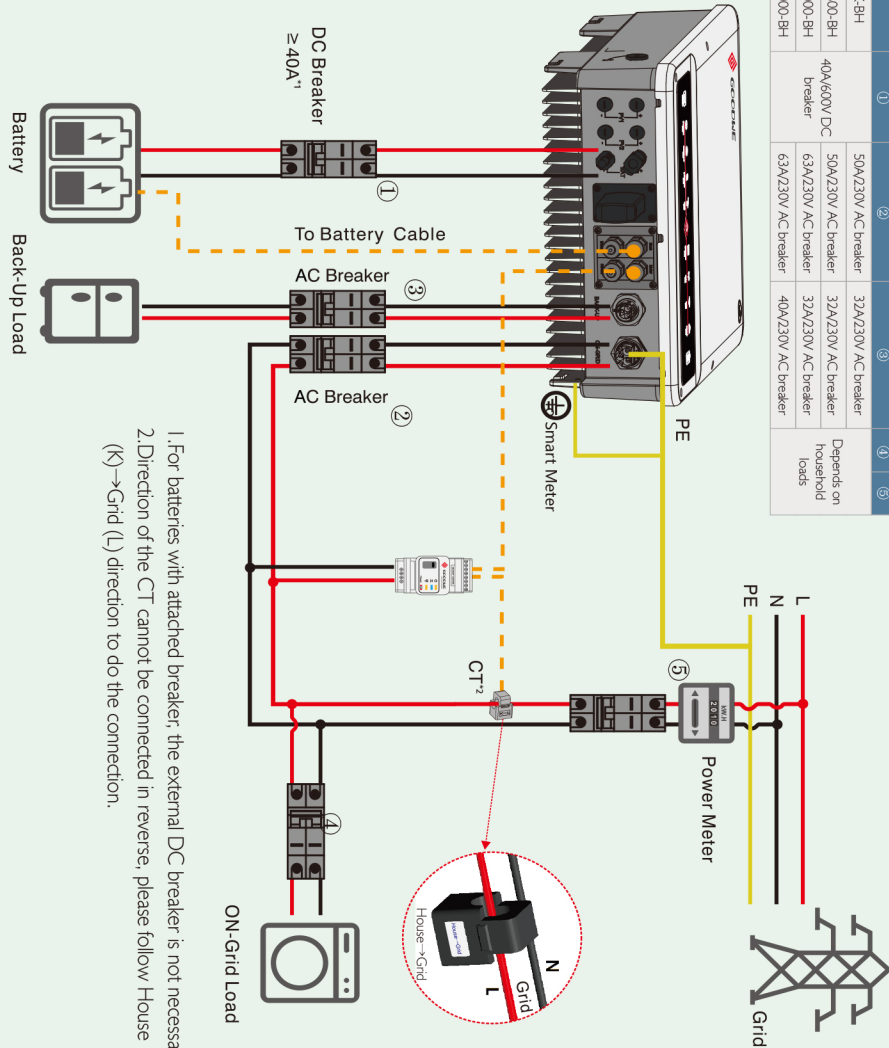

1. For batteries with attached breaker, the external DC breaker is not necessary.
2. Direction of the CT cannot be connected in reverse, please follow House (K)→Grid (L) direction to do the connection.

2. Pylon

For Pylon Power Cube-H1*4/5/6/7/8 with inverter.

Note: The SOC of battery can be charged up to 90%, but cannot be charged to 100%. (There will be no further notice if this entry is subject to change.)

A  Make sure that the inverter and the battery pack is turned off before connecting the battery pack to the inverter (Pic.1)

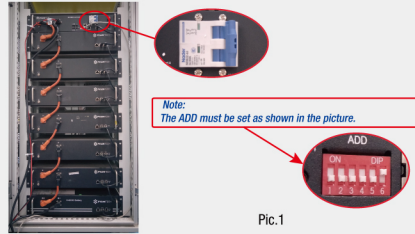

Pic.1

C To connect the cables coming from the inverter to the Pylon Battery pack, take the following steps.
Connect the power cables to the terminal block of Pylon BMU.
Connect the positive cable to "P+" and the negative to "P-". (Pic.3)

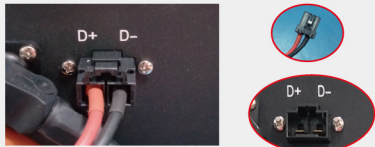

Pic.3

E The communication cable for battery is attached in the inverter. Please use the BMS cable as battery communication cable. The other end of "To Battery" cable should be connected to CAN/Link Port B of Pylon BMU.(Pic.5)



Pic. 5

F Turn on the battery switch, then press the red button for 2 seconds, the status light will turn green. Wait for about 30 seconds, if the BMS communication is normal, the status light remains green, and battery works soon later. Otherwise, the status light turns red, press the red button for 5 seconds. When the status light turns green again, the battery system is ready to work.(Pic.6)



Pic. 6

B To connect the battery packs in series, follow the instructions below.
(1)Connections of the power cable:
Connect "B+" of BMU(battery management unit) to "B+" of the first battery pack, and connect "B-" of BMU to "B-"of the last battery pack. Connect "B+" with "B-" between adjacent battery packs. The orange end corresponds to "B+", the black end corresponds to "B-".
(2) Connections of communication cable:
Connect "Link Port" of BMU to "Link Port0" of the first battery pack. For the adjacent battery packs, connect "Link Port1" to the next battery packs "Link Port0" in turn.



Pic.2

D Connect th other end of the power cable to the terminal block of the inverter.(Pic.4)

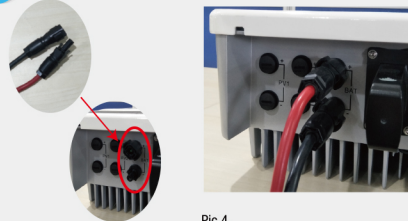

Pic.4

G On PV Master,you should choose the right battery type used in your system by "Select Battery Model" selection or battery communication will fail.(Pic.7)

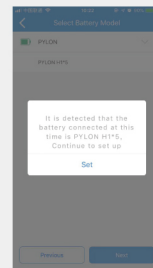

Pic.7

H After all connections and settings are done, please check if battery communication is OK on PV Master
→ Param → BMS status, which should be "Communication OK".(Pic.8)



Pic. 8

Step 3. Wi-Fi Conguration Instruction

Note:Wi-Fi Configuration could also be done on PV Master APP, for details, please download "PV Master Operation Introduction" from www.en.goodwe.com

A Preparation

1. Power Wi-Fi inverter (or Power on Inverter) on.
2. Power router on.

C Preparation

Firmware version	V1.0.4.0
MAC address	98D8631AA878
Wireless AP mode	Enable
SSID	Solar-WiFi
IP address	10.10.100.253
Wireless STA mode	Disable
Router SSID	WiFi_Burn-in
Encryption method	WPA/WPA2-PSK
Encryption algorithm	AES
Router Password	WiFi_Burn-in

Cannot join the network , maybe caused by :
router doesn't exist, or signal is too weak, or password is incorrect.
*Help: Wizard will help you to complete setting within one minute.

Press "Start Setup" to enter the next step.

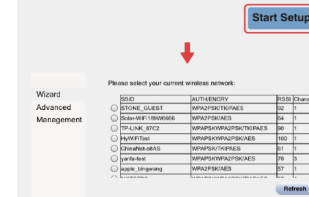

*Note: When RSSI of the selected WiFi network is lower than -90dB, the connection may be unstable, please select other available network or extend the distance between the device and router.
If your wireless router does not broadcast SSID, please click "Next" and add a wireless network manually.

If the router is not in the site list, please refer to No.4 in 'Troubleshooting'.

E Troubleshooting

No.	Problem	Checking Items
1	Cannot Find Solar-WiFi Signal	1. Make sure inverter is powered on; 2. Move your smart device closer to inverter; 3. Restart inverter; 4. Do "WiFi Reload" operation refer to user manual.
2	Cannot connect to Solar-WiFiSignal	1. Try password: 12345678; 2. Restart inverter; 3. Make sure there is no other device connected to Solar-WiFi; 4. Do "WiFi Reload" operation and try again.
3	Cannot login website 10.10.100.253	1. Make sure user name and password you use are both admin; 2. Do "WiFi Reload" operation and try again; 3. Try another browser (suggest use Google, FireFox, IE, Safari etc.); 4. Make sure website you log in is 10.10.100.253
4	Cannot find router SSID	1.Move router closer to inverter or use a Wi-Fi repeater device; 2.Connect to router and login the setting page to check the channel it uses. Please make sure the channel is not bigger than 13. Otherwise, modify it.

B Connect to 'Solar-WiFi'

1. Wi-Fi name: Solar-Wi-Fi or Solar-WiFi ("* means the last 8 characters of inverter serial No.)
Password: 12345678
2. Browse website: 10.10.100.253

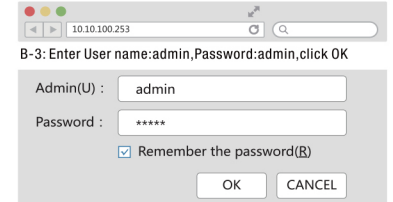

D Connect to 'Solar-WiFi'

1. Fill in router password and click 'Next'

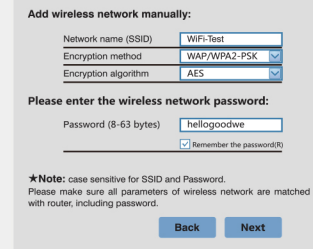

Please make sure all parameters of wireless network are matched with the router's, including password.

Save success!

Click 'Complete', the current configuration will take effect after restart.

If you still need to configure the other pages of information, please go to complete your required configuration.

Configuration is completed, you can log on the Management page to restart device by click on 'OK' button.

Confirm or complete?

Note:
The 'Solar-WiFi' signal will disappear after inverter connects to WiFi router. Turn off router or do Wi-Fi reload operation via button on inverter if you need connect to 'Solar-WiFi' once again.

No.	Problem	Checking Items
5	Cannot Find Solar-WiFi Signal	1.Restart inverter 2.Connect to Solar-WiFi and login again, check the 'SSID', 'Security Mode', 'Encryption Type' and 'Pass Phrase' is matching with that of router or not; 3.Connect to router and login to check if the connection reaches the maximum amount or not, and to check the channel of it uses. Please make sure the channel is not bigger than 13. Otherwise, modify it; 4.Restart router ; 5.Move router closer to inverter or use a Wi-Fi repeater device.
6	After configuration, WiFi Led on inverter blink four times repeatedly	1.Connect to the router and visit the portal www.goodwe-power.com. Check the portal is available or not; 2.Restart router and inverter;