



User manual

Solar Grid-tied Inverter

Product Model: SOFAR 1.1K-3.3KTL-G3



Contents

Preface.....	I
1. Basic safety information.....	- 1 -
1.1. Safety instructions.....	- 1 -
1.2. Symbols and signs.....	- 4 -
2. Product characteristics.....	- 6 -
2.1. Product dimensions.....	- 6 -
2.2. Function description.....	- 8 -
2.3. Efficiency curve.....	- 10 -
3. Installation.....	- 11 -
3.1. Installation Process.....	- 11 -
3.2. Checking Before Installation.....	- 11 -
3.3. Tools.....	- 13 -
3.4. Determining the Installation Position.....	- 15 -
3.5. Moving the SOFAR 1.1K~3.3KTL-G3.....	- 17 -
3.6. Installing SOFAR 1.1K~3.3KTL-G3.....	- 17 -
4. Electrical Connections.....	- 19 -
4.1. Electrical connection.....	- 20 -
4.2. Connecting PGND Cables.....	- 20 -
4.3. Connecting DC Input Power Cables.....	- 22 -
4.4. Connecting AC Output Power Cables.....	- 24 -
4.5. RS485,CT,inverter logic interface connection.....	- 31 -
4.6. WIFI/GPRS module installation procedure.....	- 37 -
4.7. Communication method.....	- 37 -
5. Commissioning of inverter.....	- 41 -
5.1. Safety inspection before commissioning.....	- 41 -
5.2. Start inverter.....	- 41 -
6. Operation interface.....	- 42 -
6.1. Operation and Display Panel.....	- 42 -
6.2. Standard Interface.....	- 43 -
6.3. Main Interface.....	- 45 -
6.4. Update Software online.....	- 50 -
7. Trouble shooting.....	- 52 -
7.1. Trouble shooting.....	- 52 -
7.2. Maintenance.....	- 57 -
8. Technical data.....	- 59 -
8.1. Input parameters (DC).....	- 59 -
8.2. Output parameters (AC).....	- 60 -
8.3. Efficiency,Protection and Communication.....	- 61 -
8.4. General Date.....	- 62 -
9. Quality Assurance.....	- 63 -

Notice

This manual contains important safety instructions that must be followed during installation and maintenance of the equipment.

Save these instructions!

This manual must be considered as an integral part of the equipment. The manual must always accompany the equipment, even when it is transferred to another user or field.

Copyright Declaration

The copyright of this manual belongs to Shenzhen SOFARSOLAR Co., Ltd. Any corporation or individual should not plagiarize, partially copy or fully copy it (including software, etc.), and no reproduction or distribution of it in any form or by any means. All rights reserved.

SOFARSOLAR reserves the right of final interpretation. This manual is subject to change according to user's or customer's feedback. Please check our website at <http://www.sofarsolar.com> for latest version.

Preface

Outline

Please read the product manual carefully before installation, operation or maintenance. This manual contains important safety instructions and installation instructions that must be followed during installation and maintenance of the equipment.

Scope

This product manual describes the installation, electrical connections, commissioning, maintenance and troubleshooting of SOFAR 1.1K~3.3KTL-G3 inverters:

1100TL-G3	1600TL-G3	2200TL-G3
2700TL-G3	3000TL-G3	3300TL-G3





Keep this manual where it will be accessible at all times.

Target Group

This manual is intended for qualified electrical technical personnel who are responsible for inverter installation and commissioning in the PV power system and PV plant operator.

Symbols Used

This manual provides safety operation information and uses the symbol in order to ensure personal and property security and property security and use inverter efficiently when operating the inverter. You must understand these emphasized information to avoid the personal injury and property loss. Please read the following symbols used in this manual carefully.

	<p>Danger indicates a hazardous situation which, if not avoided, will result in death or serious injury.</p>
<p>Danger</p>	
	<p>Warning indicates a hazardous situation which, if not avoided, could result in death or serious injury.</p>
<p>Warning</p>	
	<p>Caution indicates a hazardous situation which, if not avoided, could result in minor or moderate injury.</p>
<p>Caution</p>	
	<p>Attention indicates potential risks which, if not avoided, may lead to equipment fault or property damage.</p>
<p>Attention</p>	
	<p>Note provides tips that are valuable for the optimal operation of the product.</p>
<p>Note</p>	

1. Basic safety information

	If you have any question or problem when you read the following information, please contact Shenzhen SOFARSOLAR Co., Ltd.
Note	

Outlines of this chapter

Safety instruction

It mainly introduce the safety instruction when install and operate the equipment.

Symbols and signs

It mainly introduce the safety symbols on the inverter.

1.1. Safety instructions

Read and understand the instructions of this manual, and be familiar with relevant safety symbols in this chapter, then start to install and troubleshoot the equipment.

According to the national and state requirements, before connecting to the electrical grid, you must get permission from the local electrical grid operation can only be performed by qualified electrical engineer.

Please contact the nearest authorized service center if any maintenance or repair is needed. Contact your distributor for the information of the nearest authorized service center. Do NOT repair it by yourself, it may cause injury or property damage.

Before installing and maintaining the equipment, you should turn the DC switch OFF to cut off the high voltage DC of the PV array. You can also turn the switch in the PV combiner box OFF to cut off the high voltage DC. Otherwise, serious injury may be caused.

Qualified persons

The customer must make sure the operator has the necessary skill and training to do his/her job. Staff in charge of using and maintaining the equipment must be skilled, aware and mature for the described tasks and must have the reliability to correctly interpret what is described in the manual. For safety reason only a qualified electrician, who has received training and / or has demonstrated skills and knowledge in construction and in operation of this unit, can install this inverter. Shenzhen SOFARSOLAR Co., Ltd does not take any responsibility for the property destruction and personal injury because of any incorrect use.

Installation requirements

Please install inverter according to the following section. Fix the inverter on an appropriate objects with enough load bearing capacity (such as walls, PV racks etc.), and ensure that inverter is vertical placed. Choose a place suitable for installing electrical devices. And assure there is enough fire exit space, convenient for maintenance. Maintain proper ventilation to ensure enough air cycle to cool the inverter.

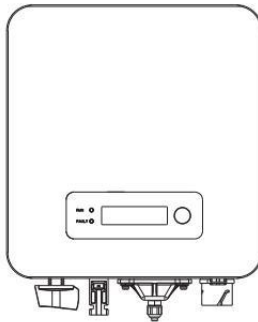

Transport requirements





If you find packing problems that may cause the damage of the inverter, or find any visible damage, please immediately notice the responsible transportation company. You can ask solar equipment installation contractor or Shenzhen

SOFARSOLAR Co.Ltd for help if necessary.



Transport of the equipment, especially by road, must be carried out with by suitable ways and means for protecting the components (in particular, the electronic components) from violent shocks, humidity, vibration, etc.

Electric connection



Please comply with all the current electrical regulations about accident prevention in dealing with the solar invert.

	Before the electrical connection, make sure to use opaque material to cover the PV modules or to disconnect PV array DC switch. Exposure to the sun, PV array will produce a dangerous voltage!
Danger	
	All installation accomplished only by professional electrical engineer! Must be trained; Completely read the manual operation and understand relevant matter.
Warning	
	Get permission from the local electrical grid operator, complete all electrical connections by professional electrical engineer, then connect inverter to electrical grid.
Attention	
	It's forbidden to remove the tamper evident label, or open the inverter. Otherwise Sofarsolar will not provide warranty or maintenance!
Note	

Operation

	Touching the electrical grid or the terminal of the equipment may lead to electrocution or fire! Don't touch the terminal or conductor connected to the electrical grid. Pay attention to any instructions or safety documents related to grid connection.
Danger	
	Some internal components will be very hot when inverter is working. Please wear protective gloves!
Attention	

Maintenance and repair



	<p>Before any repair work, turn OFF the AC circuit breaker between the inverter and electrical grid first, then turn OFF the DC switch.</p> <p>After turning OFF the AC circuit breaker and DC switch, wait for 5 minutes at least before carrying out any maintenance or repair work.</p>
Danger	
	<p>Inverter should work again after removing any faults. If you need any repair work, please contact with the local authorized service center.</p> <p>Can't open the internal components of inverter without authorized. Shenzhen SOFARSOLAR Co., Ltd. does not take any responsibility for the losses from that.</p>
Attention	

EMC / noise level of inverter

Electromagnetic compatibility (EMC) refers to that one electrical equipment functions in a given electromagnetic environment without any trouble or error, and impose no unacceptable effect upon the environment. Therefore, EMC represents the quality characters of an electrical equipment. The inherent noise-immune character: immunity to internal electrical noise. External noise immunity: immunity to electromagnetic noise of external system. Noise emission level: influence of electromagnetic emission upon environment.









	<p>Electromagnetic radiation from inverter may be harmful to health!</p> <p>Please do not continue to stay around the inverter in less than 20 cm when inverter is working.</p>
Danger	

1.2. Symbols and signs

	<p>Caution of burn injuries due to hot enclosure!</p> <p>You can only touch the screen and pressing key of the inverter while it's working.</p>
Caution	
	<p>PV array should be grounded in accordance to the requirements of the local electrical grid operator!</p> <p>We suggest that all PV module frames and inverter are reliably grounded to protect the PV system and personnel security.</p>
Attention	
	<p>Ensure input DC voltage < Max. DC voltage .Over voltage may cause permanent damage to inverter or other losses, which will not be included in warranty!</p>
Warning	

Signs on the inverter

There are some symbols which are related to security on the inverter. Please read and understand the content of the symbols, and then start the installation.

	There is a residual voltage in the inverter! Before opening the equipment, operator should wait for five minutes to ensure the capacitor is discharged completely.
	Caution, risk of electric shock.
	Caution hot surface.
	Comply with the Conformance Européenne (CE) certification.
	Grounding point.
	Please read this manual before install SOFAR 1.1K~3KTL-G3.
	This indicates the degree of protection of the equipment according to IEC standard 70-1 (EN 60529 June 1997).
	Positive pole and negative pole of the input voltage (DC).
	RCM (Regulatory Compliance Mark) The product complies with the requirements of the applicable Australian standards.

2. Product characteristics

Outlines of this chapter

Product dimensions

It introduces the field of use, and the overall dimensions of SOFAR 1.1K~3.3KTL-G3 inverters.

Function description

It introduces how SOFAR 1.1K~3.3KTL-G3 inverters work and the function modules inside.

Efficiency curves

It introduces the efficiency curves of in the inverter.

2.1. Product dimensions

SOFAR 1.1K~3.3KTL-G3 is a single MPPT grid-tied PV inverter which converts the DC power generated by PV arrays into sine wave single-phase AC power and feeds it to the public electrical grid, AC circuit breaker (refer to Section 4.4) and DC switch used as disconnect device, and the disconnect device shall be easily accessible.

Figure2-1 PV Grid-tied System

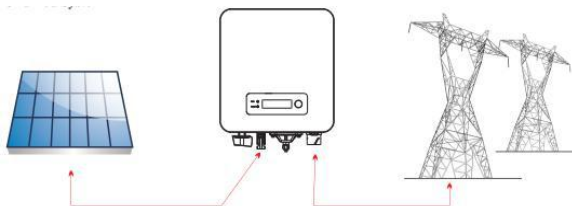

SOFAR 1.1K~3.3KTL-G3 inverters can only be used with photovoltaic modules that do not require one of the poles to be grounded. The operating current

during normal operation must not exceed the limits specified in the technical specifications. Only the photovoltaic modules can be connected to the input of the inverter (do not connect batteries or other sources of power supply).

The choice of optional parts of inverter should be made by a qualified technician who knows the installation conditions clearly.

SOFAR 1100TL-G3 SOFAR 1600TL-G3 SOFAR 2200TL-G3:

$L \times W \times H = 303\text{mm} \times 260.5\text{mm} \times 118\text{mm}$

SOFAR 2700TL-G3 SOFAR 3000TL-G3 SOFAR 3300TL-G3:

$L \times W \times H = 321\text{mm} \times 260.5\text{mm} \times 131.5\text{mm}$

Figure 2-2 Front view and left view dimensions of SOFAR 2200TL-G3

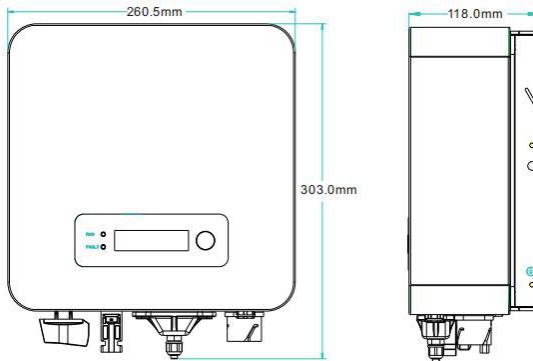

Figure 2-3 Front view and left view dimensions of SOFAR 3300TL-G3

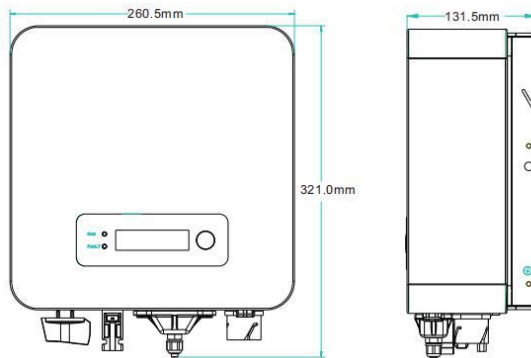
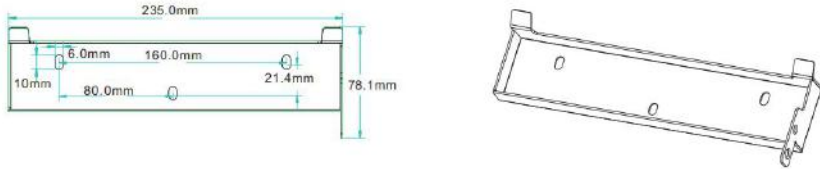

Figure 2-4 Bracket dimensions of SOFAR 1.1K~3.3KTL-G3



◆ Labels on the equipment



The labels must NOT be hidden with objects and extraneous parts (rags, boxes, equipment, etc.); the y must be cleaned regularly and kept visible at all times.

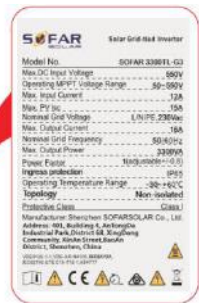
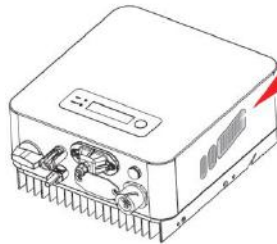

2.2. Function characteristics

DC power generated by PV array is filtered through Input Board before entering into Power Board. Input Board also offer functions such as insulation impedance detection and input DC voltage / current detection. DC power is converted to AC power by Power Board. AC power is filtered through Output Board then AC power is fed into the grid. Output Board also offer functions such as grid voltage / output current detection, GFCI and output isolation relay. Control Board provides the auxiliary power, controls the operation state of inverter and shows the operation status by Display Board. Display Board displays fault code when inverter is in abnormal operation conditions. At the same time, Control Board can trigger the relay so as to protect the internal components.

Function module

A. Energy management unit

This control can be used to switch the inverter on/off through an external (remote) control.

B. Feeding reactive power into the grid

The inverter is able to produce reactive power and can therefore feed it into the grid through the setting of the phase shift factor. Feed-in management can be controlled directly by the grid company through a dedicated RS485 serial interface.

C. Limiting the active power fed into the grid

The inverter, if enabled can limit the amount of active power fed into the grid by the inverter to the desired value (Expressed as a percentage).

D. Self power reduction when grid is over frequency

When the grid frequency is higher than the limited value, inverter will reduce output power which is necessary for the grid stability.

E. Data transmission

The inverter or a group of inverters may be monitored remotely through an advanced communication system based on RS-485 serial interface, or remotely via the WIFI/GPRS.

F. Software update

Support usb flash drive local upgrade software and WIFI/GPRS remote upgrade software.

Electrical block diagram

Figure2-5 Electrical block diagram

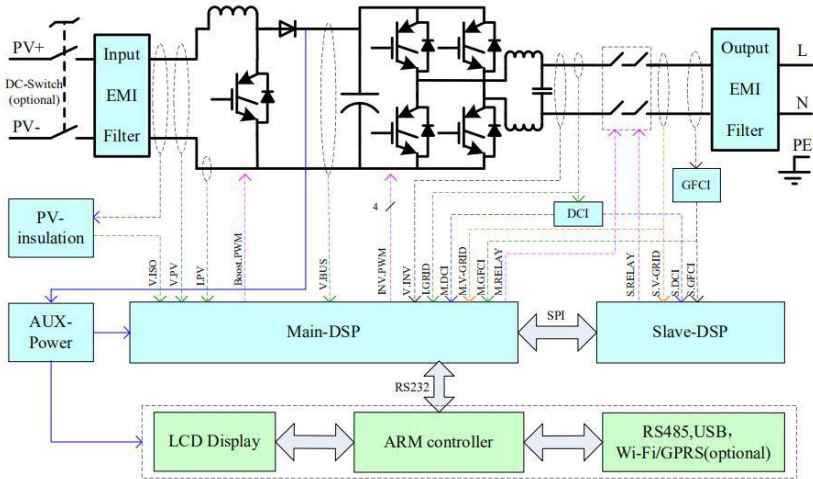

2.3. Efficiency curve

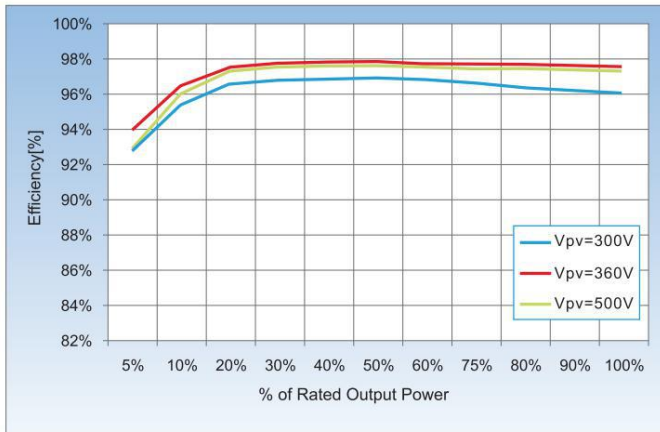



3. Installation

Outlines of this chapter

This topic describes how to install the SOFAR 1.1K~3.3KTL-G3 .

Installation notes

 Danger	<p>Do NOT install the SOFAR 1.1K~3.3KTL-G3 on flammable material.</p> <p>Do NOT install the SOFAR 1.1K~3.3KTL-G3 in an area used to store Flammable or explosive material.</p>
 Caution	<p>The enclosure and heat sink are very hot while the inverter is working, therefore do NOT install the SOFAR 1.1K~3.3KTL-G3 in places where you might touch them inadvertently.</p>
 Attention	<p>Consider the weight of SOFAR 1.1K~3.3KTL-G3 when transporting and moving the inverters.</p> <p>Choose an appropriate mounting position and surface.</p> <p>Assign at least two persons to install the inverter.</p>

3.1. Installation Process

Figure3-1 Installation flowchart

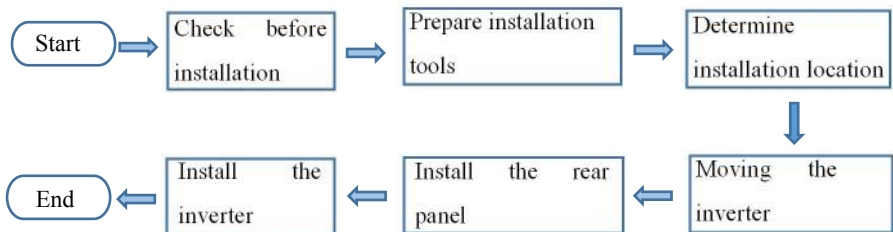

3.2. Checking Before Installation



Checking Outer Packing Materials







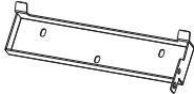
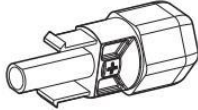
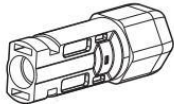

Packing materials and components may be damaged during transportation. Therefore, check the outer packing materials before installing the inverter. Check the outer packing materials for damage, such as holes and cracks. If any damage is found, do not unpack the SOFAR 1.1K~3.3KTL-G3 and contact the dealer as soon as possible. You are advised to remove the packing materials within 24 hours before installing the SOFAR 1.1K~3.3KTL-G3 inverter.

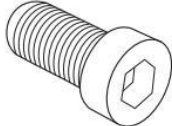
Checking Deliverables

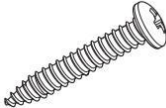
After unpacking the inverter, check whether deliverables are intact and complete. If any damage is found or any component is missing, contact the dealer.

Table3-1 shows the components and mechanical parts that should be delivered.

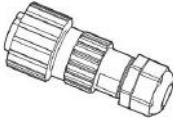





NO.	Picture	Description	Quantity
1		1.1-3.3KTL-G3	1pcs
2		Rear panel	1pcs
3		PV+ input terminal	1pcs
4		PV- input terminal	1pcs
5		Metal terminals secured to PV+ input power cables	1pcs
6		Metal terminals secured to PV- input power cables	1pcs

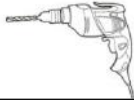

7		M5Hexagon screws	2pcs
8		Expansion bolts	3pcs
9		Self-tapping screw	5pcs
10		Manual	1pcs
11		The warranty card	1pcs
12		Registration Form	1pcs
13		AC output terminal	1pcs
14		485 terminal (2pin)	1pcs

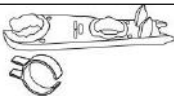
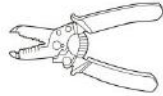
3.3. Tools

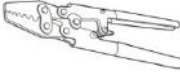
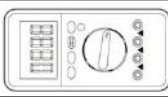
Prepare tools required for installation and electrical connections.

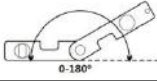
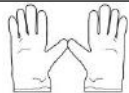
Table 3-2 shows the tools required for installation and electrical connections.

NO.	Tool	Model	Function
1		Hammer drill Recommend drill dia. 6mm	Used to drill holes on the wall.
2		Screwdriver	Wiring
3		Cross screwdriver	Remove and install AC terminal screws
4		Removal tool	Remove PV terminal
5		Wire stripper	Strip wire
6		4mm Allen Wrench	Turn the screw to connect rear panel with inverter.
7		Crimping tool	Used to crimp power cables
8		Multi-meter	Used to check grounding
9		Marker	Used to mark signs
10		Measuring tape	Used to measure distances
11		Level	Used to ensure that the rear panel is properly installed
12		ESD gloves	Operators wear

13		Safety goggles	Operators wear
14		Anti-dust respirator	Operators wear

3.4. Determining the Installation Position

Determine an appropriate position for installing the SOFAR 1.1K~3.3KTL-G3 inverter. Comply with the following requirements when determining the installation position:

Figure3-2 Installation Requirements

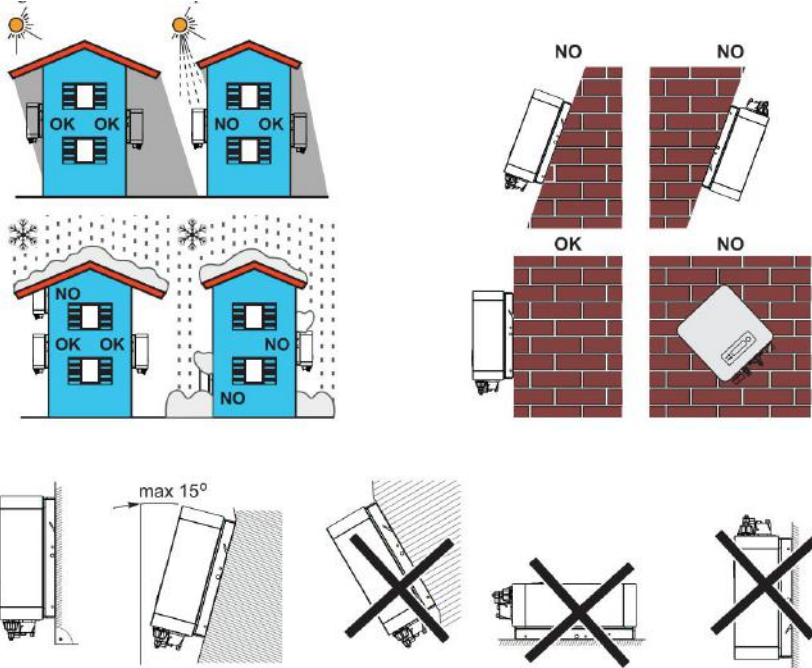

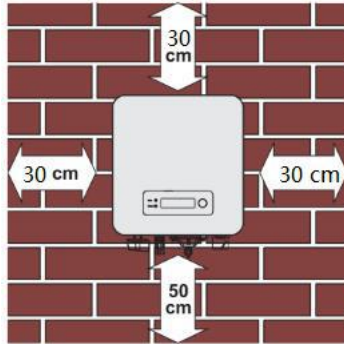

clearance for single SOFAR 1.1K~3.3KTL-G3 Inverter

Installation of multiple SOFAR 1.1K~3.3KTL-G3 inverter

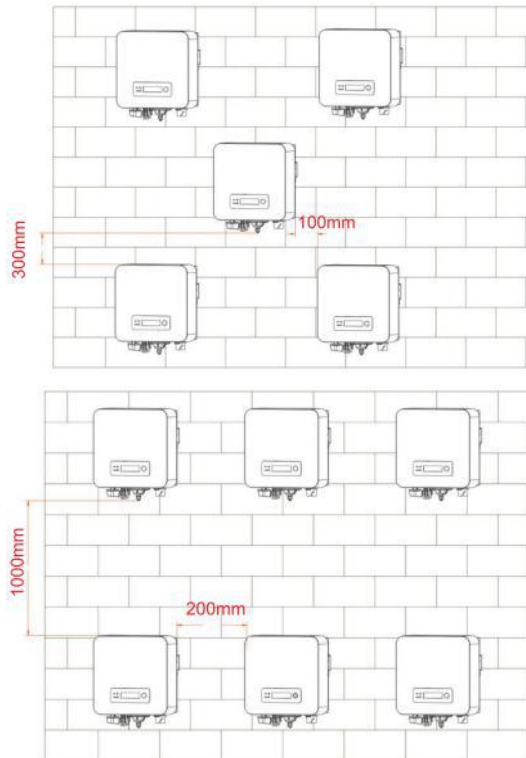

3.5. Moving the SOFAR 1.1K~3.3KTL-G3

This topic describes how to move the to the installation position Horizontally SOFAR 1.1K~3.3KTL-G3.

Step 1 Open the packaging, insert hands into the slots on both sides of the inverter and hold the handles, as shown in Figure 3-3 and Figure 3-4.

Figure 3-3 Moving the inverter (1)

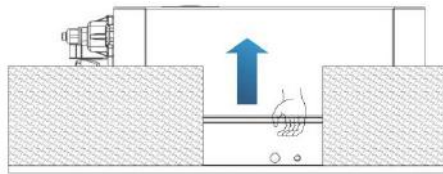
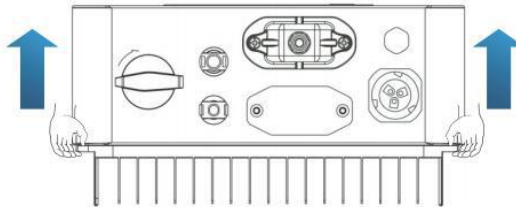



Figure 3-4 Moving the inverter (2)



Step 2 Lift the SOFAR 1.1K~3.3KTL-G3 from the packing case and move it to the installation position.

 <p>Attention</p>	<p>To prevent device damage and personal injury, keep balance when moving the inverter because the inverter is heavy.</p> <p>Do not put the inverter with its wiring terminals contacting the floor because the power ports and signal ports are not designed to support the weight of the inverter. Place the inverter horizontally.</p> <p>When placing the inverter on the floor, put foam or paper under the inverter to protect its shell.</p>
---	---

3.6. Installing SOFAR 1.1K~3.3KTL-G3

Step 1 Determine the positions for drilling holes, ensure the hole positions are

level, then mark the hole positions using a marker pen, use the hammer drill to drill holes on the wall. Keep the hammer drill perpendicular to the wall, do not shake when drilling, so as not to damage the wall. If the error of the hole positions is too big, you need to reposition.

Step 2 Insert the expansion bolt vertically into the hole, pay attention to the insertion depth of the expanding bolt (should be deep enough).

Step 3 Align the rear panel with hole positions, fix the rear panel on the wall by tightening the expansion bolt with the nuts.

Figure 3-5

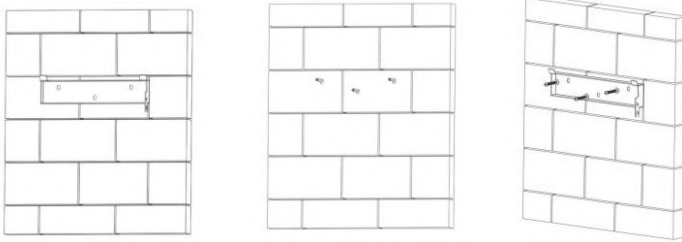

Step 4 Hook the inverter to the rear panel. Using an M5 screw to secure the inverter to the rear panel to ensure safety.

Step 5 You can secure the inverter to the rear panel and protect it from stealing by installing an anti-theft lock (this action is optional).

Figure 3-6

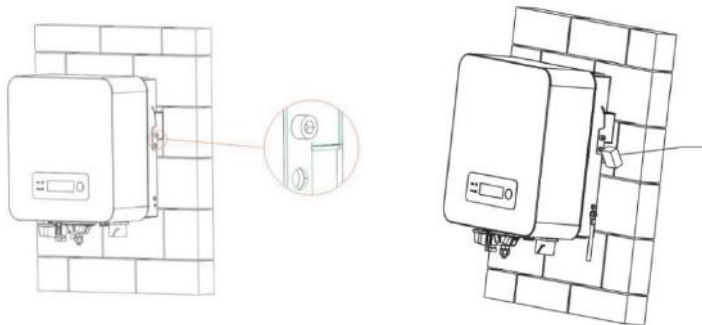



4. Electrical Connections

Outlines of this chapter

This topic describes the SOFAR 1.1K~3.3KTL-G3 inverter electrical connections. Read this part carefully before connecting cables.

NOTE: Before performing electrical connections, ensure that the DC switch is OFF. Since the stored electrical charge remains in a capacitor after the DC switch is turned OFF. So it's necessary to wait for at least 5 minutes for the capacitor to be electrically discharged.

	Installation and maintenance of inverter, must be operated by professional electrical engineer.
Attention	
	PV modules generate electric energy when exposed to sunlight and can create an electrical shock hazard. Therefore, before connecting DC input power cable, cover PV modules using opaque cloth
Danger	
	For SOFAR 1.1K~2.2KTL-G3, open-circuit voltage(Voc) of module arrays connected in series must be $\leq 500V$; For SOFAR 2.2K~3.3KTL-G3, it must be $\leq 550V$.
Note	The power of PV grid-tied system which contain by several the SOFAR 1.1K~3.3KTL-G3 inverters must be $< 3.68kw$ in Germany.

The connected PV modules must have an IEC 61730 Class A rating

IscPV(absolute maximum)	15A	
Maximum output over current protection	SOFAR1100TL-G3	5.3A
	SOFAR1600TL-G3	7.7A
	SOFAR2200TL-G3	10.6A
	SOFAR2700TL-G3	13A
	SOFAR3000TL-G3	14.5A
	SOFAR3300TL-G3	16A

The decisive voltage class(DVC)

NOTE: The DVC is the voltage of a circuit which occurs continuously between any two live part in the worst-case rated operating condition when used as intended.

Interface	DVC
-----------	-----

PV input interface	DVCC
AC output interface	DVCC
USB interface	DVCA
RS485 interface	DVCA
CT interface	DVCA
Logic interface	DVCA
WiFi/GPRS/Ethernet interface	DVCA

4.1. Electrical connection

Figure4-1 Shows the flowchart for connecting cables to the inverter.

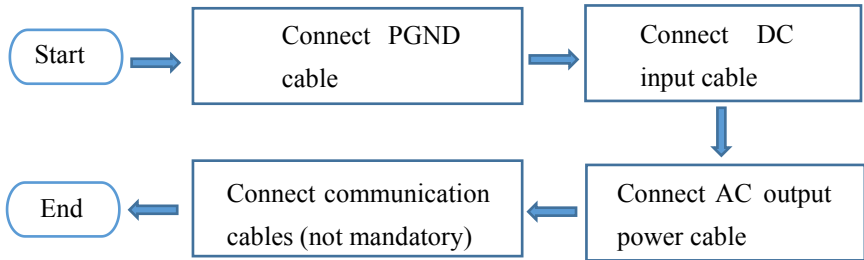

4.2. Connecting PGND Cables

Connect the inverter to the grounding electrode using protection ground (PGND) cables for grounding purpose.



Attention

The inverter is transformer-less, requires the positive pole and negative pole of the PV array are NOT grounded. Otherwise it will cause inverter failure. In the PV power system, all non current carrying metal parts (such as: PV module frame, PV rack, combiner box enclosure, inverter enclosure) should be connected to earth.

Prerequisites:

The PGND cables are prepared ($\geq 4\text{mm}^2$ outdoor power cables are recommended for grounding purposes),the color of cable should be yellow-green.

Procedure:

Step 1 Remove the insulation layer with an appropriate length using a wire

stripper, as shown in Figure 4-2.

Figure4-2 Preparing a ground cable (1)

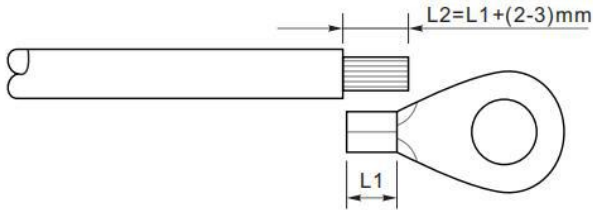

Note: L2 is 2 to 3mm longer than L1

Step 2 Insert the exposed core wires into the OT terminal and crimp them by using a crimping tool, as shown in Figure 4-3.

Figure4-3 Preparing a ground cable (2)

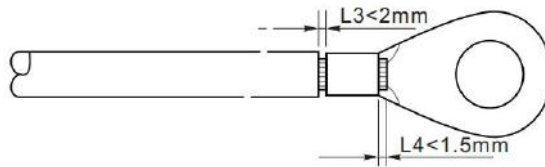

Note 1: L3 is the length between the insulation layer of the ground cable and the crimped part. L4 is the distance between the crimped part and core wires protruding from the crimped part.

Note 2: The cavity formed after crimping the conductor crimp strip shall wrap the core wires completely. The core wires shall contact the terminal closely.

Step 3 Install the crimped OT terminal, flat washer using M5 screw, and tighten the screw to a torque of 3 N.m using an Allen wrench.

Figure4-4 Ground terminal composition

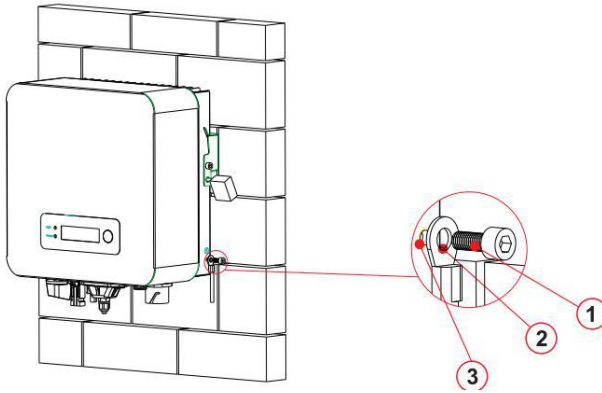

1.M5 screw、 2.OT Terminal、 3.Tapped hole

4.3. Connecting DC Input Power Cables

Table 4-1 Recommended DC input cable specifications

Cross-Sectional Area (mm ²)		External Cable Diameter(mm)
Range	Recommended Value	
4.0~6.0	4.0	4.5~7.8

Step 1 Remove cable glands from the positive and negative connectors.

Step 2 Remove the insulation layer with an appropriate length from the positive and negative power cables by using a wire stripper as show in Figure 4-5.

Figure 4-5 Connecting DC input power cables

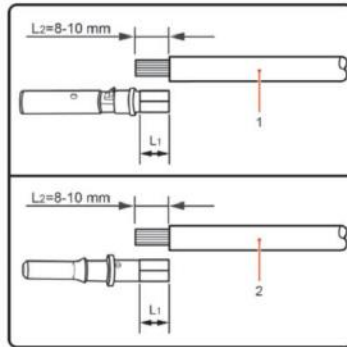

1.Positive power cable 2.Negative power cable

Note: L2 is 2 to 3 mm longer than L1.

Step 3 Insert the positive and negative power cables into corresponding cable glands.

Step 4 Insert the stripped positive and negative power cables into the positive and negative metal terminals respectively and crimp them using a clamping tool. Ensure that the cables are crimped until they cannot be pulled out by force less than 400 N, as shown in Figure 4-6.

Figure 4-6 Connecting DC input power cables

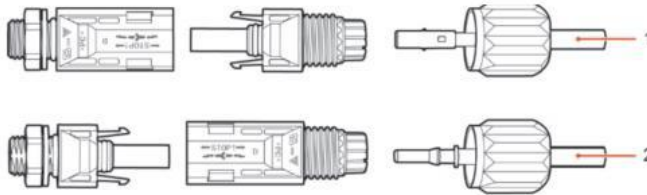

1.Positive power cable 2.Negative power cable

Step 5 Insert crimped power cables into corresponding housings until you hear a "click" sound. The power cables snap into place.

Step 6 Reinstall cable glands on positive and negative connectors and rotate them against the insulation covers.

Step 7 Insert the positive and negative connectors into corresponding DC

input terminals of the inverter until you hear a "click" sound, as shown in Figure 4-7.

Figure 4-7 Connecting DC input power cables

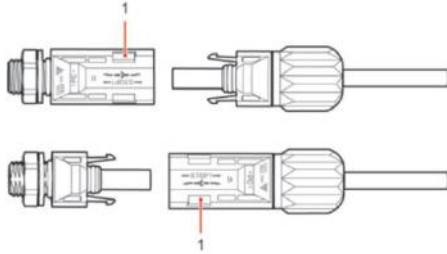

Note: Insert the stoppers into the unused DC connectors.

Follow-up Procedure

To remove the positive and negative connectors from the inverter, insert a removal wrench into the bayonet and press the wrench with an appropriate strength, as shown in Figure 4-8.

	Before removing the positive and negative connectors, ensure that the DC SWITCH is OFF.
Caution	

Figure 4-8 Removing a DC input connector

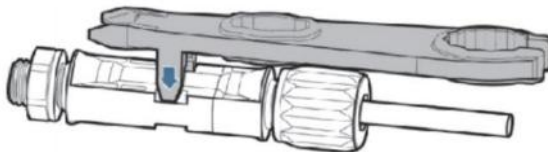

4.4. Connecting AC Output Power Cables

Connect the SOFAR 1.1K~3.3KTL-G3 to the AC power distribution frame (PDF) or power grid using AC output power cables.

	<p>It is not allowed for several inverters to use the same circuit breaker. It is not allowed to connect loads between inverter and circuit breaker.</p>
<p>Caution</p>	<p>AC breaker used as disconnect device, and the disconnect device shall remain readily operable.</p>

Context

All the AC output cables used for the inverters are outdoor three-core cables. To facilitate the installation, use flexible cables. Table 4-2 lists the recommended specifications for the cables.

Figure 4-9 NOT allowed: connect loads between inverter and circuit breaker

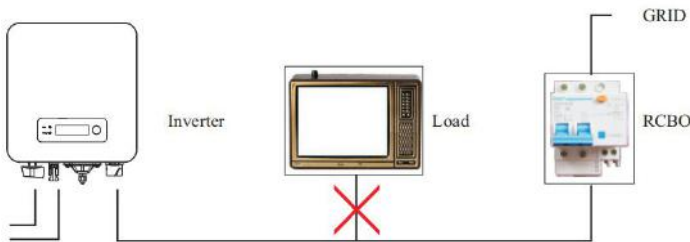
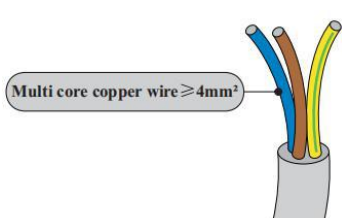

Table 4-2 Recommended AC output cable specifications

Model	SOFAR 1100TL-G3	SOFAR 1600TL-G3	SOFAR 2200TL-G3	SOFAR 2700TL-G3	SOFAR 3000TL-G3	SOFAR 3300TL-G3
Cable(Copper)	≧4mm ²	≧4mm ²	≧4mm ²	≧6mm ²	≧6mm ²	≧6mm ²
Breaker	16A/400V	16A/400V	25A/400V	25A/400V	25A/400V	25A/400V

Multi core copper wire



AC cable should be correctly sized to ensure the power loss in AC cable is less than 1% of the rated power. If the resistance of the AC cable is too high, it will cause a huge increase in the AC voltage, which may lead to a disconnection of the inverter from the electrical

grid. The relationship between power loss in AC cable and wire length, wire cross sectional area is shown in the following figure:

Figure 4-10 wire length, wire cross sectional area and wire power loss

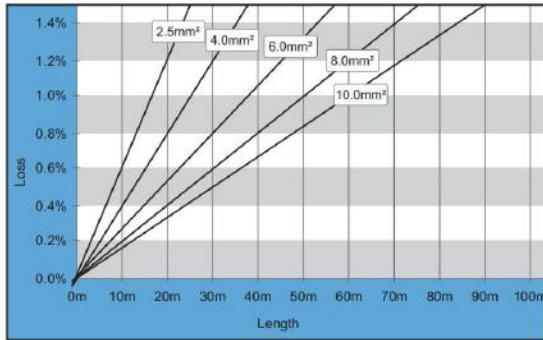

Inverter is equipped with two types of IP66 AC connector (Type I connector or Type II connector are randomly equipped with one), and the AC output cable needs to be wired by the customer. The appearance of AC connector is shown in figure 4-11.

AC connector type:

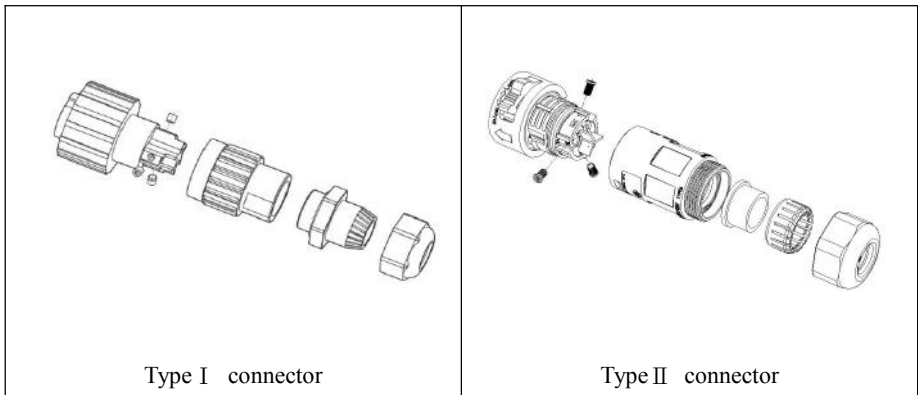

Type I connector installation instructions

Step 1 Select appropriate cables according to Table 4-2, Remove the insulation layer of the AC output cable using a wire stripper according to the figure shown below:

A: 30~50mm B:6~8mm;

Figure 4-12

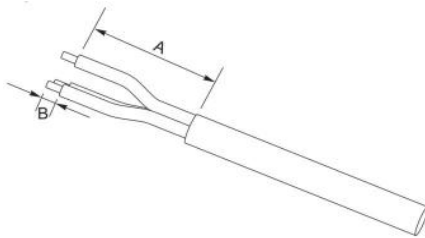

Step2 Disassemble the AC connector according to the figure shown below: insert the AC output cable (with its insulation layer stripped according to step 1) through the waterproof locking cable gland;

Figure 4-13

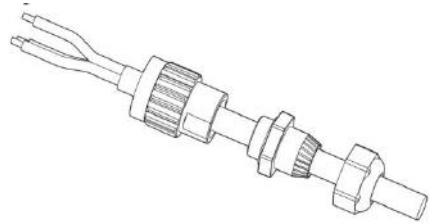

Step 3 Connect AC output cable as per the following requirements:

Connect the yellow-green wire to the hole labeled "PE", fasten the wire using an Allen wrench;

Connect the brown wire to the hole labeled "L", fasten the wire using an Allen wrench;

Connect the blue wire to the hole labeled "N", fasten the wire using an Allen wrench;

Figure 4-14

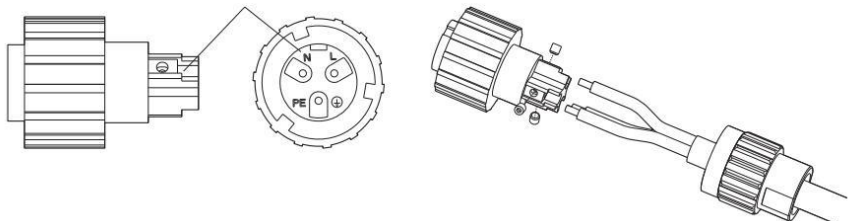

L--Brown, N--Blue, PE--Yellow-green

Step 4 Secure the locking cable gland clockwise, shown as below: make sure that all the wires are securely connected.

Figure 4-15

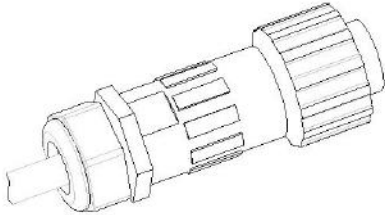

Step 5 Connect the AC connector to the output wiring connector of inverter, rotate the AC connector clockwise until the fastener reaches its designated position, as shown below.

Figure 4-16

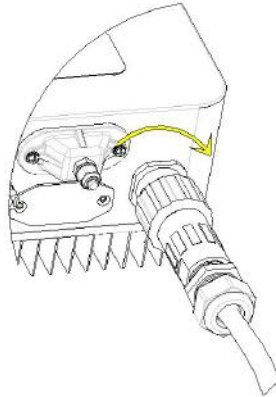

Removing the AC connector Pull out the AC connector by rotating the knob counterclockwise.

Figure 4-17

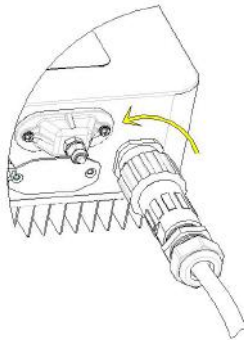



Caution

Make sure the grid is disconnected before removing the AC connector

Mode II connector installation instructions

Step 1 Select appropriate cables according to Table 4-2, Remove the insulation layer of the AC output cable using a wire stripper according to the figure shown below: A:15-25mm B:6~8mm

Figure 4-18

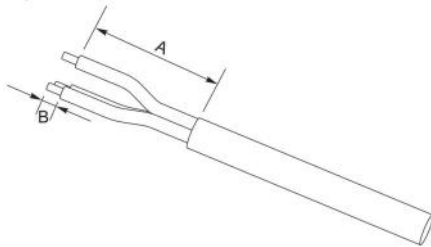

Step 2 Disassemble the AC connector according to the figure shown below: insert the AC output cable (with its insulation layer stripped according to step 1) through the waterproof locking cable gland.

Figure 4-19

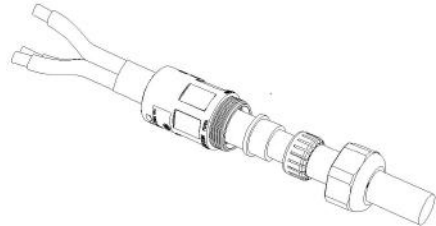

Step 3 Connect AC output cable as per the following requirements:

Connect the yellow-green wire to the hole labeled "PE", fasten the wire using an Cross screwdriver;

Connect the brown wire to the hole labeled "L", fasten the wire using an Cross screwdriver;

Connect the blue wire to the hole labeled "N", fasten the wire using an Cross screwdriver.

Figure 4-20

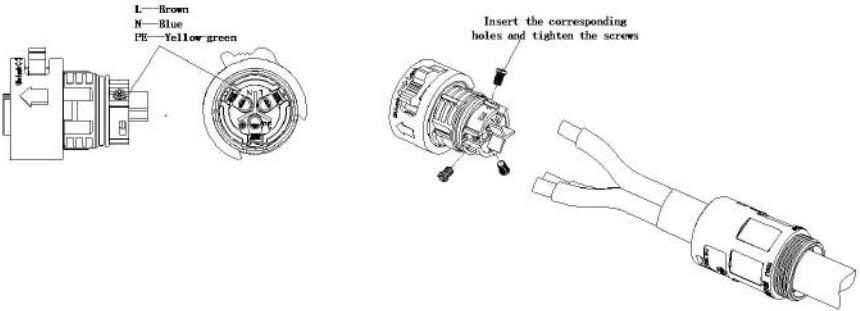

L--Brown, N--Blue, PE--Yellow-green

Step 4 Insert the AC connector and hear "click", then tighten the waterproof nut at the instantaneous value, as shown in the figure below, to ensure that the cable is firmly connected.

Figure 4-21

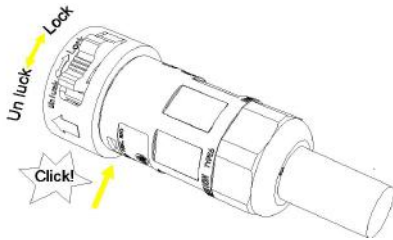

Step 5 Connect the connected AC connector to the AC connector of the inverter. Turn the ac connector knob to lock until you hear a "click" and the clasp is in place.

Figure 4-22

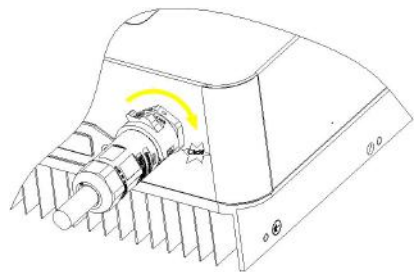

Removing the AC connector Hold the button to unlock and rotate the knob counterclockwise to the unlock position, then pull out the AC connector. Figure 4-23

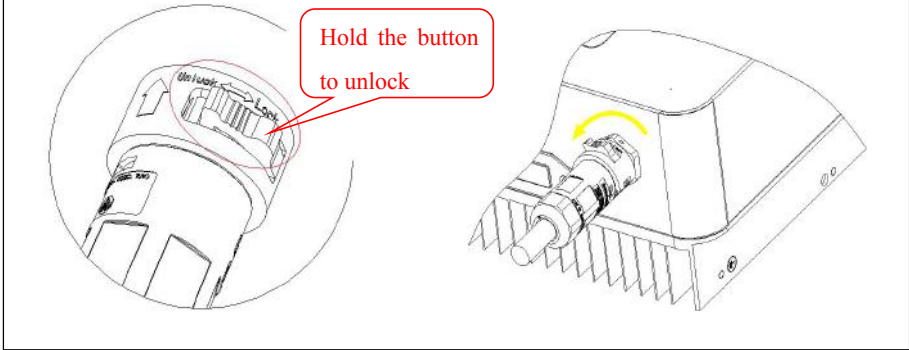

Caution

Make sure the grid is disconnected before removing the AC connector

4.5. RS485,CT,inverter logic interface connection

The communication interface location of the SOFAR1.1K~3.3KTL-G3 is shown in the figure below.

Figure 4-24

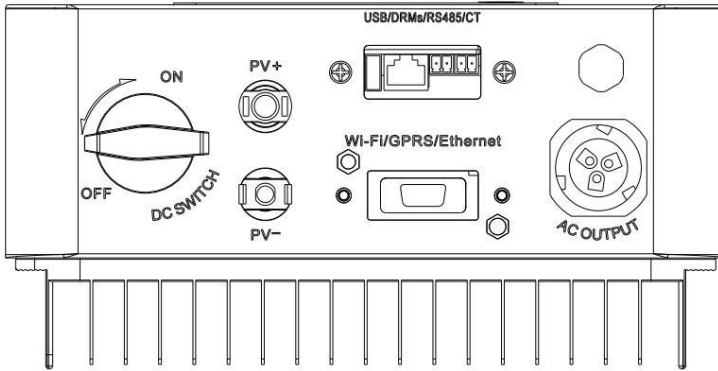
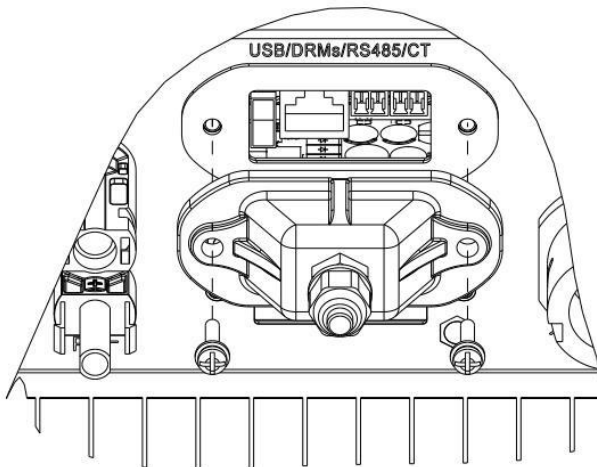

Table 4-3 Recommended communication cable size are shown below, The wiring methods are the same for RS485 and CT, this part describes their wiring methods and logic interface wiring method.

Communication function	RS485	CT
Cable size	0.5~1.5mm ²	0.5~1.5mm ²
Outside diameter	2.5~6mm	2.5~6mm

Step1 Remove the communication waterproof cover using a screwdriver;

Figure 4-25



Step2 Unlock the waterproof cable gland, remove the stopper in the

waterproof connector;

Figure 4-26

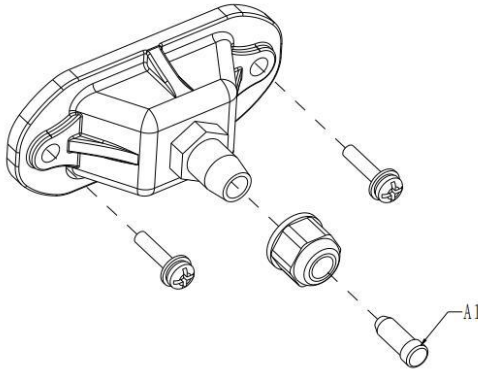

A1: Waterproof stopper

Step3 Select appropriate cable according Table4-2,remove the insulation layer using a wire stripper, the length of the wire core is about 6mm,insert the cable through the cable gland and waterproof cover, according to Table4-4,connect the wires as per the labels, and secure the wire using a slotted screwdriver.as shown in the figure below:

Table 4-4 Function description of the communication terminals



Type	RS485		CT		Logic interface
Connector					
Label	TX-	TX+	CT-	CT+	The following table
Function	RS485 differential signal-	RS485 differential signal+	CT-	CT+	

Figure 4-27



The logic interface pin definitions and circuit connections are as follows:

The function of logical interface needs to be set on the display screen, please refer to the operation steps in section 6.3 .

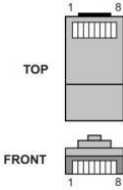
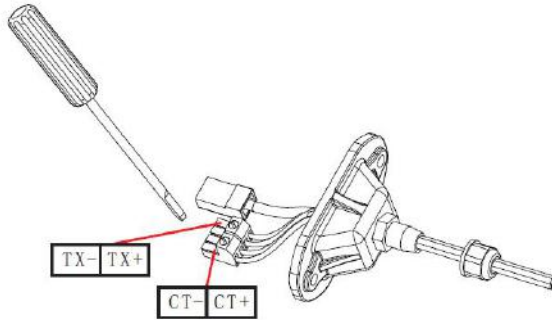
Logic interface pin are defined according to different standard requirements.

(a) Logic interface for AS/NZS 4777.2:2015, also known as inverter demand response modes (DRMs).

The inverter will detect and initiate a response to all supported demand response commands within 2 s. The inverter will continue to respond while the mode remains asserted.

Table 4-5 Function description of the DRMs terminal

Pin NO.	Color	Function
1	White and orange	DRM1/5
2	Orange	DRM2/6
3	White and green	DRM3/7
4	Blue	DRM4/8
5	White and blue	RefGen
6	Green	DRM0
7	White and brown	Pin7&Pin8 short internal
8	Brown	

NOTE: Supported DRM command: DRM0, DRM5, DRM6, DRM7, DRM8.

(b) Logic interface for VDE-AR-N 4105:2018-11, is in order to control and/or limit the inverter’s output power.

The inverter can be connected to a RRCR (Radio Ripple Control Receiver) in order to dynamically limit the output power of all the inverters in the installation.

Figure 4-28 Inverter – RRCR Connection

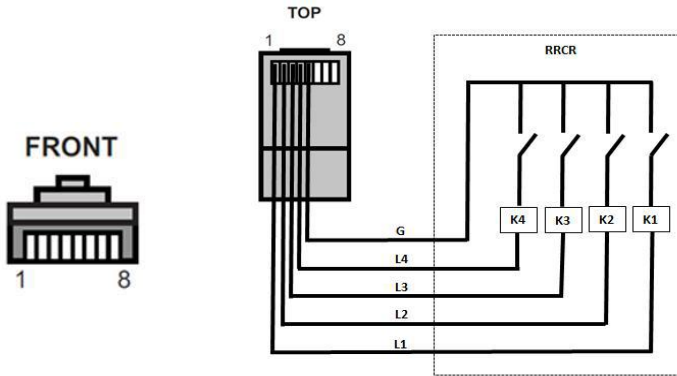

Table 4-6 Function description of the terminal

Pin NO.	Pin name	Description	Connected to (RRCR)
1	L1	Relay contact 1 input	K1 - Relay 1 output
2	L2	Relay contact 2 input	K2 - Relay 2 output
3	L3	Relay contact 3 input	K3 - Relay 3 output
4	L4	Relay contact 4 input	K4 - Relay 4 output
5	G	GND	Relays common node
6	NC	Not Connected	Not Connected
7	NC	Not Connected	Not Connected
8	NC	Not Connected	Not Connected

Table 4-7 The inverter is preconfigured to the following RRCR power levels

Relay status: close is 1, open is 0

L1	L2	L3	L4	Active Power	Cos(φ)
1	0	0	0	0%	1
0	1	0	0	30%	1
0	0	1	0	60%	1
0	0	0	1	100%	1

(c) Logic interface for EN50549-1:2019, is in order to cease active power output within five seconds following an instruction being received at the input interface.

Figure 4-29 Inverter – RRCR Connection

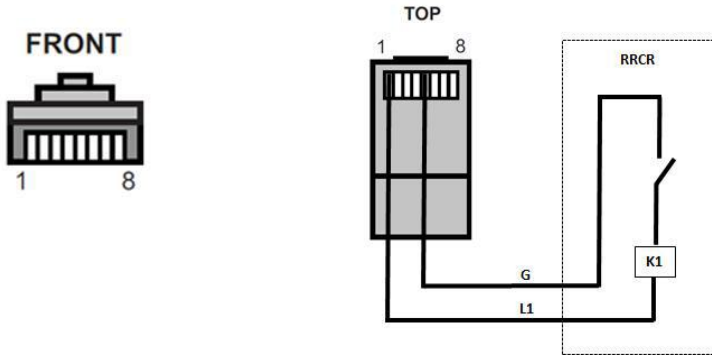

Table 4-8 Function description of the terminal

Pin NO.	Pin name	Description	Connected to (RRCR)
1	L1	Relay contact 1 input	K1 - Relay 1 output
2	NC	Not Connected	Not Connected
3	NC	Not Connected	Not Connected
4	NC	Not Connected	Not Connected
5	G	GND	K1 - Relay 1 output
6	NC	Not Connected	Not Connected
7	NC	Not Connected	Not Connected
8	NC	Not Connected	Not Connected

Table 4-9 The inverter is preconfigured to the following RRCR power levels.

Relay status: close is 1, open is 0

L1	Active Power	Power drop rate	Cos(φ)
1	0%	< 5 seconds	1
0	100%	/	1

Step4 Insert the terminal as per the printed label, and then tighten the screws to fix the waterproof cover, rotate the cable gland clockwise to fasten it securely.

Figure 4-30

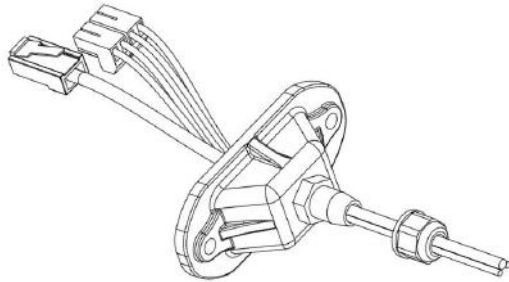
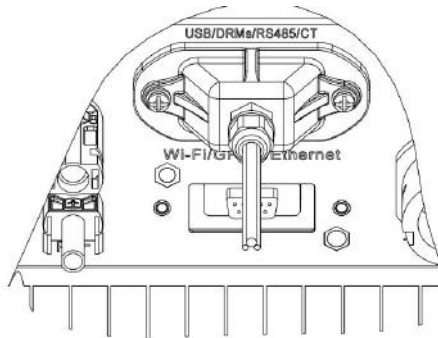

Figure 4-31



4.6. WIFI/GPRS module installation procedure

Step1: Remove wifi/GPRS waterproof cover using screw driver.

Step2: Install WIFI/GPRS module.

Step3: Fasten WIFI/GPRS module using screws.

4.7. Communication method

SOFAR 1.1K~3.3KTL-G3 grid-connected inverters offer RS485 (standard) and Wi-Fi (optional) communication modes:

A. Communication between one inverter and one PC:

1. RS485

Refer to the figure shown below, connect the TX+ and TX- of the inverter to the TX+ and TX- of the RS485 → USB adapter, and connect the USB port of the adapter to the computer.(NOTE1)

Figure 4-32

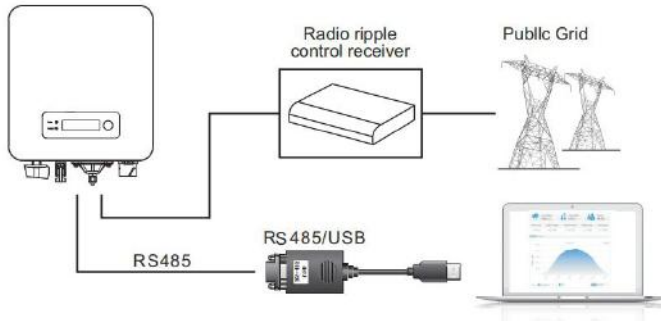

2. WI-FI

Refer to the figure shown below: (wireless function required for the PC).(NOTE4)

Figure 4-33



The operation information (generated energy, alert, operation status) of the inverter can be transferred to PC or uploaded to the server via Wi-Fi. You can register on the website.

http://www.solarmanpv.com/portal/Register/Regi_Pub.aspx

Using the Wi-Fi S/N number(NOTE3), then you can login the website:

<http://www.solarmanpv.com/portal/LoginPage.aspx> to remote monitors the inverter.

B. Communication between multiple inverters and one PC:

1. RS485

Refer to the following figure: RS485 wires are connected in parallel between inverters, refer to section 4.5 of this manual for wire connection methods. Connect the TX+ and TX- of the inverter to the TX+ and TX- of the RS485→USB adapter; connect the USB port of the adapter to the computer. A maximum of 31 inverters can be connected in one daisy chain.(NOTE2)

Figure 4-34

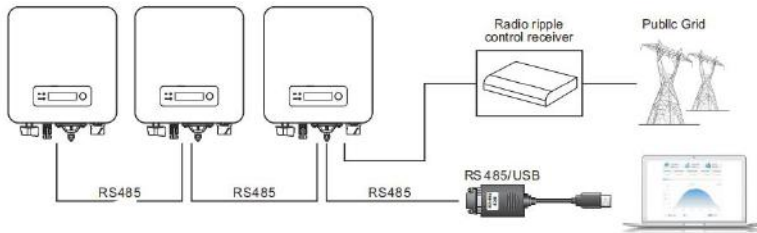

2. WI-FI

Refer to the figure shown below: (wireless function required for the PC).(NOTE4)

Figure 4-35



The operation information (generated energy, alert, operation status) of the inverter can be transferred to PC or uploaded to the server via Wi-Fi. You can register on the website.

http://www.solarmanpv.com/portal/Register/Regi_Pub.aspx

Using the Wi-Fi S/N number(NOTE3), then you can login the website:

<http://www.solarmanpv.com/portal/LoginPage.aspx> to remote monitors the inverter.

**Note1:**

The length of the RS485 communication cable should be less than 1000 m.

**Note2:**

When multiple inverters are connected via RS485 wires, set mod-bus address to differentiate the inverters.

**Note3:**

S/N number of the Wi-Fi module is located on the side.

5. Commissioning of inverter

5.1. Safety inspection before commissioning

	Ensure that DC and AC voltages are within the acceptable range of the inverter.
Attention	

5.2. Start inverter

Step 1: Turn ON the DC switch.(optional)

Step 2: Turn ON the AC circuit breaker.

When the DC power generated by the solar array is adequate, the SOFAR 1.1K~3.3KTL-G3 inverter will start automatically. Screen showing “normal” indicates correct operation.

NOTE: Choose the correct country code. (refer to section 6.3 of this manual)

Notice: Different distribution network operators in different countries have different requirements regarding grid connections of PV grid connected inverters.

Therefore, it's very important to make sure that you have selected the correct country code according to requirements of local authority. Please consult qualified electrical engineer or personnel from electrical safety authorities about this.

Shenzhen SOFARSOLAR Co., Ltd. is not responsible for any consequences arising out of incorrect country code selection.

If the inverter indicates any fault, please refer to Section 7.1 of this manual — trouble shooting for help.

6. Operation interface

Outlines of this chapter

This section introduces the display, operation, buttons and LED indicator lights of SOFAR 1.1K~3.3KTL-G3 Inverter.

6.1. Operation and Display Panel

Buttons and Indicator lights



Button:

Long press the button to enter the next menu or confirm the selection

Short press the button to achieve the next page turning function

Turn down the loop once to exit

Indicator Lights:

RUN (Green)

ON: “ Normal ” state

Flash: “ Wait ” or “ Check ” state

FAULT (Red)

ON: “ Fault ” or “ Permanent ” state

6.2. Standard Interface

Normal
PV1:193V- 0.3A

Normal
Power: 0.13kW

Normal
Today: 0.06kWh

Normal
Tot: 74kWh

Normal
Grid:227V- 0.6A

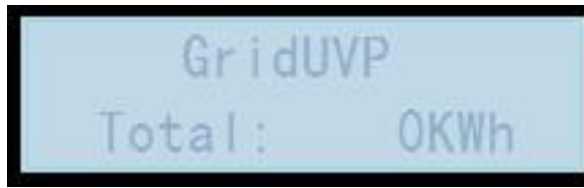
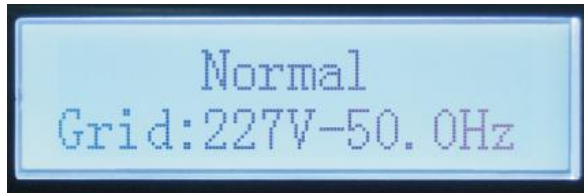

When power-on, LCD interface displays INITIALIZING, refer below picture.



When control board successfully connected with communication board, the LCD display the current state of the inverter, display as shown in the figure below.



• Waiting States, Countdown 10S
(depends country code, some are 60s)



• Checking



• Normal Power Generation



Inverter states includes: wait、 check、 normal、 fault and permanent

Wait:Inverter is waiting to Check State at the end of reconnection time. In this state, grid voltage value is between the max and min limits and so on; If not, Inverter will go to Fault State or Permanent State.

Check: Inverter is checking isolation resistor, relays, and other safety requirements. It also does self-test to ensure inverter software and hardware are functional. Inverter will go to Fault State or Permanent State if any error or fault occurs.

Normal: Inverter enter to Normal State, it is feeding power to the grid; inverter will go to Fault State or Permanent state if any error or fault occurs.

Fault:Fault State: Inverter has encountered recoverable error. It should recover if the errors disappear. If Fault State continues; please check the inverter according error code.

Permanent:Inverter has encountered unrecoverable error, we need maintainer debug this kind of error according to error code.

When the control board and communication board connection fails, the LCD display interface as shown in the figure below.



6.3. Main Interface

Long press the button under standard interface to enter into main interface,

including:

Normal	-----Long press the button
	1.Enter Setting
	2.Event List
	3.SystemInfo
	4.Display Time
	5.Software Update

(A) “Enter Setting” Interface as below:

1.Enter Setting	-----Long press the button	
	1.Set time	12.Set Safety Voltage
	2.Clear Energy	13.Set Safety Frequency
	3.Clear Events	14.Insulation Resistance
	4.Set Country	15.Set Reactive
	5.On-Off Control	16.Set Power Derate
	6.Enable Set Country	17.Reflux Power
	7.Set Energy	18.MPPT Scan
	8.Set Address	19.Logic Interface
	9.Set Input mode	20.Set Power Ratio
	10.Set Language	
	11.Set Start Parameter	

Long press the button to Enter the main interface of "1.Enter Setting" and long press to enter the setting menu. You can select the content you want to set by short pressing the button.

Note1: Some settings need to enter the password (the default password is 0001), when entering the password, short press to change the number, long press to confirm the current number, and long press after entering the correct password.If "password error, try again" appears, you will need to re-enter the correct password.

1. Set Time

Set the system time for the inverter.

2. Clear Energy

Clean the inverter of the total power generation.

3. Clear Events

Clean up the historical events recorded in the inverter.

4. Set Country

Set up the safety regulation country that meets the current use conditions and requirements. Before setting this item, ensure that the “Enable Set Country” option are enabled. Please refer to “7.Enable Set Country” for details.

Table6-1 country code setting

*Mark serial number for temporarily can not set safety regulations country

code	country	code	country	code	country
00	Germany VDE AR-N4105	20	Korea	40*	Thailand PEA
01	CEI0-21 Internal	21	Sweden	41*	Thailand MEA
02	Australia	22	Europe General	42*	LV-Range-50HZ
03	Spain RD1699	23	CEI0-21 External	43	EU EN50549
04	Tuekey	24	Cyprus	44	South Africa
05	Denmark	25	India	45	AU-WA
06	Greece Continent	26	Philippines	46	Dubai DEWG
07	Netherland	27	NewZealand	47	Dubai DEWG MV
08	Belgium	28	Brazil	48*	Taiwan
09	UK-G99	29	Slovakia VSD	49*	AU-VIC
10	China	30	Slovakia SSE		
11	France	31	Slovakia ZSD		
12	Poland	32	CEI0-21 In Areti		
13	Germany BDEW	33	Ukraine		
14	Germany VDE 0126	34	Brazil LV		
15	Italy CEI0-16	35*	Mexico LV		
16	UK-G98	36*	FAR Arrete23		
17	Greece island	37*	Denmark Tr322		
18	EU EN50438	38	Wide-Range-60HZ		
19	IEC EN61727	39	Ireland EN504		

5. On-Off Control

Inverter on-off local control.

6. Enable Set Country

Enable this option before setting the country.

Attention: when inverter working for power generation over 24h, country setting is forbidden, it can only be set after LCD setting. Key in passwords for country setting through LCD (default: 0001), country setting can be set in 24h after keying in the correct passwords, over 24h, set through LCD again.

7. Set Energy

Set the total power generation. You can modify the total power generation through this option.

8. Set address

Set the address (when you need to monitor multiple inverters simultaneously), Default 01.

9. Set Input mode

The input modes of the SOFAR inverter are divided into parallel mode and independent mode (when multi-channel MPPT is input). Since SOFAR 1.1k ~ 3.3KTL-G3 has only one group of MPPT input, the input modes are not distinguished.

10. Set Language

Set the inverter display language.

11. Set Start Parameter

12. Set Safety Voltage

13. Set Safety Frequency

14. Insulation Resistance

User can modify the above 4 parameters of the machine through the SD card, and the user needs to copy the parameter information that needs to be modified into the SD card in advance.

Note: To enable this feature, please contact the Sofarsolar technical support .

15. Set Reactive

Enable or disable reactive functions.

16. Set Power Derate

Enable or disable the power derate function of the inverter, and set the derate ratio.

17. Reflux Power

Enable or disable the anti-reflux function of the inverter, and set the reflux power. This function needs to be used with external CT, please refer to this manual 4.5 RS485, CT, inverter logic interface connection for details.

18. MPPT Scan

Shadow scanning, when the component is blocked or abnormal, causing multiple power peaks, by enabling this function, the peak point of maximum power can be tracked.

19. Logic interface

Enable or disable logical interfaces. Please refer to this manual 4.5 RS485, CT, inverter logic interface connection for details.

20. Set Power Ratio (The country is set at 10)

Set generation ratio.

(B) “Event List” Interface as below:

Event List is used to display the real-time event records, including the total number of events and each specific ID No. and happening time. User can enter Event List interface through main interface to check details of real-time event records, Event will be listed by the happening time, and recent events will be listed in the front. Please refer to below picture. Long press the button and short press the button to turn the page in standard interface, then enter into “2.Event List” interface.

2. Event List	
1. Current event	2. History event

Fault information	001 ID04 06150825 (Display the event sequence number, event ID number, and event occurrence time)
-------------------	--

(C) “SystemInfo” Interface as below

3.SystemInfo	-----Long press the button	
	1.Inverter Type	8.Power Factor
	2.Serial Number	9.Reflux Power
	3.Soft Version	10.Safety Paras
	4.Hard Version	11.MPPT Scan
	5.Country	12.Power Ratio
	6.Modbus Address	
	7.Input Mode	

The user enters the main menu by long pressing the button, short press and turns the page to select menu contents, then long press the button to enter "3. SystemInfo". Turning the page down can select the system information to view.

(D) Display Time

Long press the button and short press the button to turn the page in the standard user interface to enter into “4.Display Time”,then long press the button to display the current system time.

(E) Software Update

User can update software by USB flash drive , Sofarsolar will provide the new update software called firmware for user if it is necessary,The user needs to copy the upgrade file to the USB flash drive.

6.4. Update Software online

SOFAR 1.1K~3.3KTL-G3 inverters offer software upgrade via usb flash drive to maximize inverter performance and avoid inverter operation error caused by software bugs.

Step 1 First,turn off the DC and AC breaker,and then remove the communication waterproof cover as the following picture.If the RS485 line has been connected,Be sure to release the waterproof nut,Make sure the communication line is no longer the force. Then remove the waterproof cover,In order to avoid loosening the communication plug which has been connected.

Step 2 Insert the usb flash drive into the compute.

Step 3 SOFAR SOLAR will send the Software code to the user who needs to update. After user receive the file,please decompressing file and cover the original file in usb flash drive.

Step 4 Insert the usb flash drive into the USB interface.

Step 5 Then turn on DC switch and enter into the online upgrade to the main menu"5.Software Update"in the LCD display program[6.3(E)].The method to enter the menu can refer to operation interface of LCD.

Step 6 Input the password,if password is correct,and then begin the update process,the original password is 0715.

Step 7 System update main DSP, slave DSP and ARM in turns.If main DSP update success,the LCD will display"Update DSP1 Success", otherwise display "Update DSP1 Fail";If slave DSP update success,the LCD will display"Update DSP2 Success",otherwise display "UpdateDSP2 Fail".

Step 8 If Fail,please turn off the DC breaker,wait for the LCD screen extinguish,then turn on the DC breaker again,then Continue to update from step 5.

Step 9 After the update is completed,turn off the DC breaker, wait for the LCD screen extinguish,then recover the communication waterproof and then turn on the DC breaker and AC breaker again,the inverter will enters the running state. User can check the current software version in SystemInfo>>>3.SoftVersion.

7. Trouble shooting

Outlines of this chapter

This topic describes how to perform daily maintenance and troubleshooting to ensure long term proper operation of the inverter.

7.1. Trouble shooting

This section contains information and procedures for solving possible problems with the inverter.

- This section help users to identify the inverter fault. Please read the following procedures carefully:
- ✧ Check the warning, fault messages or fault codes shown on the inverter screen, record all the fault information.
- ✧ If there is no fault information shown on the screen, check whether the following requirements are met:
 - Is the inverter mounted in a clean, dry place with good ventilation?
 - Is the DC switch turned ON?
 - Are the cables adequately sized and short enough?
 - Are the input and output connections and wiring in good condition?
 - Are the configuration settings correct for the particular installation?
 - Are the display panel and the communication cables properly connected and undamaged?

Follow the steps below to view recorded problems: Long press the button to enter the main menu from the standard interface. Select “ 2. Event List ” then long press the button to enter event list.

- **Earth Fault Alarm**

This inverter complies with IEC 62109-2 clause 13.9 for earth fault alarm

monitoring.

If an Earth Fault Alarm occurs, the fault will be displayed on the LCD screen, the red light will be on, and the fault can be found in the history of the fault. For the machine installed with Wi-Fi/GPRS, the alarm information can be seen on the corresponding monitoring website, and can also be received by the APP on the mobile phone.

Table 7-1 Event list

Event List NO.	Event List Name	Event List description	Solution
ID01	GridOVP	The power grid voltage is too high	<p>If the alarm occurs occasionally, the possible cause is that the electric grid is abnormal occasionally. inverter automatically returns to normal operating status when the electric grid's back to normal.</p> <p>If the alarm occurs frequently, check whether the grid voltage/frequency is within the acceptable range. If no, contact technical support. If yes, check the AC circuit breaker and AC wiring of the inverter.</p> <p>If the grid voltage/frequency is within the acceptable range and AC wiring is correct, while the alarm occurs repeatedly, contact technical support to change the grid over-voltage, under-voltage, overfrequency, under-frequency protection points after obtaining approval from the local electrical grid operator.</p>
ID02	GridUVP	The power grid voltage is too low	
ID03	GridOFP	The power grid frequency is too high	
ID04	GridUFP	The power grid frequency is too low	
ID05	PVUVP	The input voltage is too low	<p>Check whether too few PV modules are series connected in a PV string, thus the voltage(Vmp) of the PV string is lower than the minimum operating voltage of inverter. If yes, adjust the number of series connected PV modules to increase the voltage of the PV string to fit the input voltage range of inverter. inverter automatically returns to normal operating status after correct adjustments.</p>
ID09	PVOVP	The input voltage is too high	<p>Check whether too many PV modules are series connected in a PV string, thus the voltage(Voc) of the PV string is higher than the maximum input voltage of inverter. If yes, adjust the number of series connected PV modules to decrease the voltage of the PV string to fit the input voltage range of inverter. inverter automatically returns to normal operating status after correct adjustments.</p>
ID10	IpvUnbalance	Input current is not	Check the input mode(parallel mode/

		balanced	independent mode) setting of inverter according to Section 6.3 (C) 6.Input Mode of this user manual. If it's incorrect, change it according to Section 6.3 (A) 10.Set Input mode of this manual.
ID11	PvConfigSetWrong	Incorrect input mode	
ID12	GFCIFault	GFCI Fault	If the fault occurs occasionally, the possible cause is that the external circuits are abnormal occasionally. inverter automatically returns to normal operating status after the fault is rectified.If the fault occurs frequently and lasts a long time,check whether the insulation resistance between the PV array and earth(ground) is too low, then check the insulation conditions of PV cable.
ID14	HwBoostOCP	The input current is too high , and has happen hardware protection	Check whether the input current is higher than the maximum input current of inverters, then check the input wiring, if both are correct, please contact technical support.
ID15	HwAcOCP	The grid current is too high , and has happen hardware protection	ID15-ID24 are internal faults of inverter, turn OFF the “DC switch”, wait for 5 minutes, then turn ON the “DC switch”. Check whether the fault is rectified. If no, please contact technical support.
ID16	AcRmsOCP	The grid current is too high	
ID17	HwADFaultIGrid	The grid current sampling error	
ID18	HwADFaultDCI	The DCI sampling error	
ID19	HwADFaultVGri d	The grid voltage sampling error	
ID20	GFCIDeviceFault	The GFCI sampling error	
ID21	MChip_Fault	The master chip fault	
ID22	HwAuxPowerFault	The auxiliary voltage error	
ID23	BusVoltZeroFault	The bus voltage sampling error	
ID24	IacRmsUnbalance	The Output current is not balanced	
ID25	BusUVP	The bus voltage Is too low	If the PV array configuration is correct (no ID05 fault), the possible cause is that the solar irradiance is too low. inverter automatically returns to normal operating status after the solar irradiance returns to normal level.
ID26	BusOVP	The bus voltage Is too high	ID26-ID27 are internal faults of inverter, turn OFF the “DC switch”, wait for 5 minutes, then turn ON the “DC switch”. Check whether the fault is rectified. If no, please contact
ID27	VbusUnbalan	The bus voltage is not balanced	

			technical support.
ID28	DciOCP	The Dci is too high	<p>Check the input mode(parallel mode/independent mode) setting of inverter according to Section 6.3 (C) 6.Input Mode of this user manual, If it's incorrect, change it according to Section 6.3 (A) 10.Set Input mode of this manual.</p> <p>If the input mode is correct, turn OFF the "DC switch", wait for 5 minutes, then turn ON the "DC switch". Check whether the fault is rectified. If no, please contact technical support, If it's incorrect, change it according to Section 6.3 (A) 10.Set Input mode of this manual.</p>
ID29	SwOCPInstan	The grid current is too high	<p>Internal faults of inverter, turn OFF the "DC switch", wait for 5 minutes, then turn ON the "DC switch". Check whether the fault is rectified. If no, please contact technical support.</p>
ID30	SwBOCPInstan	The input current is too high	<p>Check whether the input current is higher than the maximum input current of inverters, then check the input wiring, if both are correct, please contact technical support.</p>
ID49	ConsistentFault_VGrid	The grid voltage sampling value between the master DSP and slave DSP is not consistent	<p>ID49-ID55 are internal faults of inverter, turn OFF the "DC switch", wait for 5 minutes, then turn ON the "DC switch".Check whether the fault is rectified. If no, please contact technical support.</p>
ID50	ConsistentFault_FGrid	The grid frequency sampling value between the master DSP and slave DSP is not consistent	
ID51	ConsistentFault_DCI	The DCI sampling value between the master DSP and slave DSP is not consistent	
ID52	ConsistentFault_GFCI	The GFCI sampling value between the master DSP and slave DSP is not consistent	
ID53	SpiCommLose	The spi communication between the master DSP and slave DSP is fault	
ID54	SciCommLose	The Sci communication between the control board	

		communication board is fault	
ID55	RelayTestFail	The relays fault	
ID56	PvIsoFault	The insulation resistance is too low	Check the insulation resistance between the PV array and earth(ground), if a short circuit occurs, rectify the fault.
ID57	OverTempFault_Inv	The inverter temp is too high	Ensure the installation position and installation method meet the requirements of Section 3.4 of this user manual.
ID58	OverTempFault_Boost	The Boost temp is too high	Check whether the ambient temperature of the installation position exceeds the upper limit.
ID59	OverTempFault_Env	The environment temp is too high	If yes, improve ventilation to decrease the temperature.
ID65	UnrecoverHwAcOCP	The grid current is too high,and has cause unrecoverable hardware fault	ID65-ID70 are internal faults of inverter, turn OFF the “DC switch”, wait for 5 minutes, then turn ON the “DC switch”. Check whether the fault is rectified. If no, please contact technical support.
ID66	UnrecoverBusOVP	The bus voltage is too high,and has cause unrecoverable fault	
ID67	UnrecoverIacRmsUnbalance	The grid current is unbalance,and has cause unrecoverable fault	
ID68	UnrecoverIpvUnbalance	The input current is unbalance,and has cause unrecoverable fault	
ID69	UnrecoverVbusUnbalance	The bus voltage is unbalance,and has cause unrecoverable fault	
ID70	UnrecoverOCPInstant	The grid current is too high,and has cause unrecoverable fault	
ID71	UnrecoverPvConfigSetWrong	Incorrect input mode	
ID74	UnrecoverIPVInstant	The input current is too high,and has cause unrecoverable fault	ID74-ID77 are internal faults of inverter, turn OFF the “DC switch”, wait for 5 minutes, then turn ON the “DC switch”. Check whether the fault is rectified. If no, please contact technical support.
ID75	UnrecoverWRIT EEPROM	The EEPROM is unrecoverable	

ID76	Unrecoverable EEPROM	The EEPROM is unrecoverable	
ID77	Unrecoverable Relay Fail	Relay has happened permanent fault	
ID81	Over Temp Derating	The inverter has derated because of the temperature is too high	Ensure the installation position and installation method meet the requirements of Section 3.4 of this user manual. Check whether the ambient temperature of the installation position exceeds the upper limit. If yes, improve ventilation to decrease the temperature.
ID82	Over Freq Derating	The inverter has derated because of the grid frequency is too high	Inverter automatically reduce the output power when the frequency of electrical grid is too high.
ID83	Remote Derating	The inverter has derated by the Remote control	Inverter records ID83 in case of remote power derating operation. Check the wiring of remote input and output control signal port on the communication board according to Section 4.5 of this user manual.
ID84	Remote Off	The inverter has shut down because by the Remote control	Inverter records ID84 in case of remote shutdown operation. Check the wiring of remote input and output control signal port on the communication board according to Section 4.5 of this user manual.
ID94	Software version is not consistent	The software between the control board and the communication board is not consistent	Contact technical support to upgrade software.
ID95	Communication board EEPROM fault	The communication board EEPROM is fault	ID95~ID96 are internal faults of inverter, turn OFF the “DC switch”, wait for 5 minutes, then turn ON the “DC switch”. Check whether the fault is rectified. If no, please contact technical support.
ID96	RTC clock chip anomaly	RTC clock chip is fault	
ID97	Invalid Country	The country is invalid	Check the country setting according to Section 6.3 (C) 5. Country of this user manual, If it's incorrect, change it according to Section 6.3 (A) 4. Set Country Code of this manual.
ID98	SD fault	The SD card is fault	Please replace the SD card.

7.2. Maintenance

Inverters generally do not need any daily or routine maintenance. Heat sink should not be blocked by dust, dirt or any other items. Before the cleaning, make

sure that the DC SWITCH is turned OFF and the circuit breaker between inverter and electrical grid is turned OFF. Wait at least for 5 minutes before the Cleaning.

✧ **Inverter cleaning**

Please clean the inverter with an air blower, a dry & soft cloth or a soft bristle brush. Do NOT clean the inverter with water, corrosive chemicals, detergent, etc.

✧ **Heat sink cleaning**

For the long-term proper operation of inverters, ensure there is enough space around the heat sink for ventilation, check the heat sink for blockage (dust, snow, etc.) and clean them if they exist. Please clean the heat sink with an air blower, a dry & soft cloth or a soft bristle brush. Do NOT clean the heat sink with water, corrosive chemicals, detergent, etc.

8. Technical data

Outlines of this chapter

This topic lists the technical specifications for all SOFAR 1.1K~3.3KTL-G3 inverters.

8.1. Input parameters (DC)

Technical Data	SOFAR 1100TL- G3	SOFAR 1600TL- G3	SOFAR 2200TL- G3	SOFAR 2700TL- G3	SOFAR 3000TL- G3	SOFAR 3300TL- G3
Max.DC power	1500W	2200W	3000W	3700W	4100W	4500W
Max.Input voltage	500V			550V		
Aux Start-up voltage	60V					
Start-up input voltage	70V					
MPPT voltage range	50-500V			50-550V		
Rated input voltage	360V					
Full load DC voltage range	110-450V	150-450V	200-450V	250-500V	275-500V	300-500V
Max. Input current	12A					
Input short circuit current	15A					
Number of MPPT/ Number of DC input	1/1					
Input terminal type	MC4/H4					

8.2. Output parameters (AC)

Technical Data	SOFAR 1100TL- G3	SOFAR 1600TL- G3	SOFAR 2200TL- G3	SOFAR 2700TL- G3	SOFAR 3000TL- G3	SOFAR 3300TL- G3
Rated Output power	1100W	1600W	2200W	2700W	3000W	3300W
Max.Output power	1100VA	1600VA	2200VA	2700VA	3000VA	3300VA
Rated Output current	4.8A	7A	9.6A	11.8A	13A	14.3A
Max.Output current	5.3A	7.7A	10.6A	13A	14.5A	16A
Nominal grid voltage	L/N/PE,220Vac 230Vac 240Vac					
Grid voltage range	180-276Vac(According to local grid standard)					
Nominal grid frequency	50Hz/60Hz					
Grid frequency range	45~55Hz/54~66Hz(According to local grid standard)					
THDi	<3%					
Power factor	1 default(+/-0.8 adjustable)					

8.3. Efficiency, Protection and Communication

Technical Data	SOFAR 1100TL- G3	SOFAR 1600TL- G3	SOFAR 2200TL- G3	SOFAR 2700TL- G3	SOFAR 3000TL- G3	SOFAR 3300TL- G3
Max. Efficiency	97.5%			97.7%		
Euro Efficiency	96.9%			97.2%		
MPPT Efficiency	>99.9%					
Self-consumption at night	<1W					
Safety protection	Anti islanding, RCMU, Ground fault monitoring					
Certification	AS 4777, VDE V 124-100, VDE V 0126-1-1, VDE-AR-N 4105, EN 50438, G83/2, C10/11, RD1699					
Protective class	Class I					
External environment pollution degree	Degree 3					
Overvoltage category	PV: OVC II, AC mains: OVC III					
Max inverter Back-feed current to the array	0A					
Output short circuit current to the array	200A/1us					
Output inrush current and duration	0.8A/2us					

8.4. General Date

Technical Data	SOFAR 1100TL- G3	SOFAR 1600TL- G3	SOFAR 2200TL- G3	SOFAR 2700TL- G3	SOFAR 3000TL- G3	SOFAR 3300TL- G3
Topology	Transformerless					
Ambient temperature range	-30~60℃					
Permissible humidity range	0~100%					
Noise figure	<25dB					
DC Switch	Optional					
Cooling	Natural convection					
Max.Operating altitude	2000m					
Outline Dimension	303*260.5*118mm			321*260.5*131.5mm		
Bracket	Wall-mounted					
Weight	5.5kg			6.3kg		
Display	LCD+LED					
Communication mode	RS485.WiFi/GPRS(optional),USB					
Degree of protection	IP65					

9. Quality Assurance

Standard warranty period

The standard warranty period of inverter is 60 months (5 years). There are two calculation methods for the warranty period:

1. Purchase invoice provided by the customer: the first flight provides a standard warranty period of 60 months (5 years) from the invoice date;
2. The customer fails to provide the invoice: from the production date (according to the SN number of the machine), Our company provides a warranty period of 63 months (5.25 years).
3. In case of any special warranty agreement, the purchase agreement shall prevail.

Extended warranty period

Within 12 months of the purchase of the inverter (based on the purchase invoice) or within 24 months of the production of the inverter (SN number of machine, based on the first date of arrival), Customers can apply to buy extended warranty products from the company's sales team by providing the product serial number, Our company may refuse to do not conform to the time limit extended warranty purchase application. Customers can buy an extended warranty of 5, 10, 15 years.

If the customer wants to apply for the extended warranty service, please contact the sales team of our company. to purchase the products that are beyond the purchase period of extended warranty but have not yet passed the standard quality warranty period. Customers shall bear different extended premium.

During the extended warranty period, pv components GPRS, WIFI and

lightning protection devices are not included in the extended warranty period. If they fail during the extended warranty period, customers need to purchase and replace them from the our company.

Once the extended warranty service is purchased, our company will issue the extended warranty card to the customer to confirm the extended warranty period.

Invalid warranty clause

Equipment failure caused by the following reasons is not covered by the warranty:

- 1) The "warranty card" has not been sent to the distributor or our company;
- 2) Without the consent of our company to change equipment or replace parts;
- 3) Use unqualified materials to support our company 's products, resulting in product failure;
- 4) Technicians of non-company modify or attempt to repair and erase the product serial number or silk screen;
- 5) Incorrect installation, debugging and use methods;
- 6) Failure to comply with safety regulations (certification standards, etc.);
- 7) Damage caused by improper storage by dealers or end users;
- 8) Transportation damage (including scratches caused by internal packaging during transportation).Please claim directly from the transportation company or insurance company as soon as possible and obtain damage identification such as container/package unloading;
- 9) Failure to follow the product user manual, installation manual and maintenance guidelines;
- 10) Improper use or misuse of the device;
- 11) Poor ventilation of the device;
- 12) The product maintenance process does not follow relevant standards;
- 13) Failure or damage caused by natural disasters or other force majeure (such as earthquake, lightning strike, fire, etc.)

Statement

If you have purchased this product in Australia, you should be aware that this warranty is provided in addition to other rights and remedies held by a consumer at law.

Our goods come with guarantees that cannot be excluded under the Australian Consumer Law. You are entitled to a replacement or refund for a major failure and compensation for any other reasonably foreseeable loss or damage. You are also entitled to have the goods repaired or replaced if the goods fail to be of acceptable quality and the failure does not amount to a major failure.



Product Name: PV Grid-Connected Inverter

Company Name: Shenzhen SOFARSOLAR Co., Ltd.

ADD: 401, Building 4, AnTongDa Industrial Park, District 68, XingDong Community,
XinAn Street, BaoAn District, Shenzhen, Guangdong.P.R. China

Email: service@sofarsolar.com

Tel: 0510-6690 2300

Web: www.sofarsolar.com