

User manual

# PV Grid-Connected Inverter

Product Model: SOFAR 3.3K-12KTL-X (2021.03.17)



## Notice

This manual contains important safety instructions that must be followed during installation and maintenance of the equipment.

## Save these instructions!

This manual must be considered as an integral part of the equipment, and must be available at all times to everyone who interacts with the equipment. The manual must always accompany the equipment, even when it is transferred to another user or field.

## Copyright Declaration

The copyright of this manual belongs to Shenzhen SOFARSOLAR Co., Ltd. Any corporation or individual should not plagiarize, partially copy or fully copy it (including software, etc.), and no reproduction or distribution of it in any form or by any means. All rights reserved. SOLARSOFAR reserves the right of final interpretation. This manual is subject to change according to user's or customer's feedback. Please check our website at <http://www.sofarsolar.com> for latest version.

## Shenzhen SOFARSOLAR Co., Ltd.

ADD:401, Building 4, AnTongDa Industrial Park, District 68, XingDong Community,  
XinAn Street, BaoAn District, Shenzhen, Guangdong, P.R. China

[Http://www.sofarsolar.com](http://www.sofarsolar.com)

P. C. : 518000

E-mail: [service@sofarsolar.com](mailto:service@sofarsolar.com)

# Preface

## Outline

Please read the product manual carefully before installation, operation or maintenance. This manual contains important safety instructions and installation instructions that must be followed during installation and maintenance of the equipment.

### • Scope

This product manual describes the assembly, installation, commissioning, and maintenance of the following inverters.

**SOFAR 3.3KTL-X\*** ; **SOFAR 4.4KTL-X** ; **SOFAR 5KTL-X\*** [Australia] ; **SOFAR 5.5KTL-X** ;  
**SOFAR 6.6KTL-X** ; **SOFAR 8.8KTL-X** ; **SOFAR 11KTL-X** ; **SOFAR 12KTL-X**

(The models marked with "\*" should be available only for some designated countries.)





Keep this manual where it will be accessible at all times.

### • Target Group

This manual is for qualified person (support person, service person are qualified mentioned in this manual).

### • Symbols Used

This manual provides safety operation information and uses the symbol in order to ensure personal and property security and use the inverter efficiently when operating the inverter. You must understand these emphasize information to avoid the personal injury and property loss. Please read the following symbols which used in this manual carefully.

 <b>Danger</b>	<b>Danger indicates a hazardous situation which, if not avoided, will result in death or serious injury.</b>
 <b>Warning</b>	<b>Warning indicates a hazardous situation which, if not avoided, could result in death or serious injury.</b>
 <b>Caution</b>	<b>Caution indicates a hazardous situation, if not avoided, could result in minor or moderate injury.</b>
 <b>Attention</b>	<b>Attention indicates there are potential risks. If fail to prevent, may lead to equipment cannot run normally or property damage.</b>
 <b>Note</b>	<b>Note provides tips that are valuable for the optimal operation of the product.</b>

# Table of contents

<b>Preface</b> .....	<b>II</b>
<b>1 Basic safety information</b> .....	<b>1</b>
1.1 Safety instructions .....	1
1.2 Symbols and signs .....	3
<b>2 Product characteristics</b> .....	<b>5</b>
2.1 Product identification .....	5
2.2 Function description .....	7
2.3 Protection modules .....	8
<b>3 Installation</b> .....	<b>9</b>
3.1 Installation Process .....	9
3.2 Checking Before Installation .....	9
3.3 Tools .....	11
3.4 Determining the Installation Position .....	13
3.5 Installing the Sofar 3.3K~12KTL-X .....	14
<b>4 Electrical Connections</b> .....	<b>16</b>
4.1 Electrical connection .....	16
4.2 Connecting PGND Cables .....	16
4.3 Connecting AC Output Power Cables .....	17
4.4 Connecting Communications Cables .....	19
4.5 Connecting DC Input Power Cables .....	23
4.6 DRMs Functions .....	27
4.7 Safety check .....	28
<b>5 Commissioning of inverter</b> .....	<b>29</b>
5.1 Safety inspection before commissioning .....	29
5.2 Start inverter .....	29

<b>6 Operation interface</b> .....	<b>30</b>
6.1 Operation and Display Panel .....	30
6.2 Standard Interface .....	31
6.3 Main Interface .....	33
<b>7 Trouble shooting and maintenance</b> .....	<b>45</b>
7.1 Trouble shooting .....	45
7.2 Maintenance .....	49
<b>8 Decommissioning</b> .....	<b>50</b>
8.1 Decommissioning steps .....	50
8.2 Package .....	50
8.3 Storage .....	50
8.4 Disposal .....	50
<b>9 Technical data</b> .....	<b>51</b>
9.1 Input parameter (DC) .....	51
9.2 Output parameter (AC) .....	52
9.3 Efficiency, Safety and Protection .....	52
9.4 General Data .....	53
<b>10 Quality Assurance</b> .....	<b>54</b>
10.1 Standard warranty period .....	54
10.2 Extended warranty period .....	54
10.3 Invalid warranty clause .....	54

# Basic safety information

	<p>If you have any question or problem when you read the following information, please contact Shenzhen SOFARSOLAR Co., Ltd.</p>
<b>Note</b>	

## 1.1 Safety instructions

Read and understand the instruction of this manual ,and be familiar with relevant safety symbols in the paragraph, then start to install and debug the equipment.According to the national and state requirements, before connect the grid ,you must get power department permission, and perform the operation only by qualified electrical engineer.Before installing and maintaining the equipment, you should cut off the high voltage application of PV array. You can also open the switch of Solar Array Combiner to cut off the high voltage. Otherwise, serious injury may be caused.

### Qualified persons

The customer must make sure the operator has the necessary skill and training to do his/her job. Staff in charge of using and maintaining the equipment must be skilled, aware and mature for the described tasks and must have the reliability to correctly interpret what is described in the manual. For safety reason only a qualified electrician, who has received training and / or has demonstrated skills and knowledge in construction and in operation of this unit, can install this inverter. Shenzhen SOFARSOLAR Co., Ltd does not take any responsibility for the property destruction and personal injury because of any incorrect use.

## Assembly situation requirements





Please install and start inverter according to the following sections. Put the inverter in appropriate bearing capacity objects(such as wall and components and so on), to ensure that inverter vertical placed. Choose suitable place for installing electrical equipment. And assure enough fire exit space, convenience for maintenance. Maintain proper ventilation, and ensure that have the enough air cooling cycle.

## Transport requirements

If you find packing problems that may cause the damage of the inverter, or find any visible damage, please immediately notice the responsible transportation company. You can ask solar equipment installation contractor or Shenzhen SOFARSOLAR Co.Ltd for help if necessary. Transport of the equipment, especially by road, must be carried out with by suitable ways and means for protecting the components (in particular, the electronic components) from violent shocks, humidity, vibration, etc.



## Electric connection

Please comply with all the current electrical regulations about accident prevention in dealing with the current inverter.



 <b>Danger</b>	<p><b>Before the electrical connection, make sure to use opaque material to cover the PV modules or to disconnect PV array DC switch. Exposure to the sun, PV array will produce a dangerous voltage!</b></p>
 <b>Warning</b>	<p><b>All installation accomplished only by professional electrical engineer!</b></p> <ul style="list-style-type: none"> <li>• must be trained;</li> <li>• Completely read the manual operation and understand relevant matters.</li> </ul>
 <b>Attention</b>	<p><b>Only get permission by the local power department and complete all electrical connection by professional electrical engineer then connect inverter into grid!</b></p>
 <b>Note</b>	<p><b>The equipment is composed of two cases. It's forbidden to remove the tamper evident label, and open the upper case. Otherwise Sofarsolar will not provide service and maintenance.!</b></p>



## Operation





	<p><b>Touching the power grid or the terminal of equipment may lead to die of electric shock or fire!</b></p> <ul style="list-style-type: none"> <li>• Don't touch the terminal or conductor which connect to the power circuit;</li> <li>• Pay attention to anything about grid connection and security document.</li> </ul>
<b>Danger</b>	
	<p><b>Some internal components will be very hot when inverter is working. Please wear protective gloves!</b></p>
<b>Attention</b>	

## Maintenance and repair

	<ul style="list-style-type: none"> <li>• Disconnected with the PV components array and electricity grid before any repair work;</li> <li>• After turn off AC breaker and DC switch for 5 minutes later, the maintenance or repair of the inverter can be carried out!</li> </ul>
<b>Danger</b>	
	<ul style="list-style-type: none"> <li>• Inverter should work again after removing any faults. If you need any repair work, please contact with the local authorized service center;</li> <li>• Can't open the internal components of inverter without authorized. Shenzhen SOFARSOLAR Co., Ltd. does not take any responsibility for the losses from that.</li> </ul>
<b>Attention</b>	









## 1.2 Symbols and signs

### Safety symbols

	<p><b>Electromagnetic radiation from inverter may be harmful to health!</b></p> <ul style="list-style-type: none"> <li>• Please do not continue to stay away from the inverter in less than 20 cm when inverter is working.</li> </ul>
<b>Danger</b>	
	<p><b>Caution of burn injuries due to hot enclosure parts!</b></p> <ul style="list-style-type: none"> <li>• During working only can touch the display and key parts of inverter.</li> </ul>
<b>Caution</b>	
	<p><b>PV array should be connected to the ground in accordance with requirements of local power department!</b></p> <ul style="list-style-type: none"> <li>• To protect system and the personnel security, we suggest that PV array of border and inverter should be reliable grounding .</li> </ul>
<b>Attention</b>	
	<p><b>Ensure input DC voltage &lt; Max.DC voltage .Over voltage may cause permanent damage to inverter or other losses, which will not be included in warranty!</b></p>
<b>Warning</b>	

## Signs on the inverter

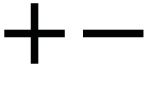
There are some symbols which are related to security on the inverter. Please read and understand the content of the symbols, and then start the installation.

	<p>There is residual voltage in the inverter! Before open the equipment, operator should wait for five minutes to ensure the capacitance discharge completely.</p>
	<p>Be careful of high voltage.</p>
	<p>Be careful of high temperature.</p>
	<p>Conformity with European.</p>
	<p>Point of connection for grounding.</p>
	<p>This indicates the allowed temperature range.</p>
	<p>This indicates the degree of protection of the equipment according to IEC standard 70-1 (EN 60529 June 1997).</p>
	<p>Positive pole and negative pole of the input voltage (DC).</p>
	<p>RCM (Regulatory Compliance Mark) The product complies with the requirements of the applicable Australian standards</p>



**Intended grid types:**

Sofar 3.3K ~ 12KTL-X inverters are compatible with TN-S, TN-C, TN-C-S, TT, IT grid configurations. For the TT type of electricity grid, the voltage between neutral and earth should be less than 30V.

Figure2-2 Overview of the grid configurations

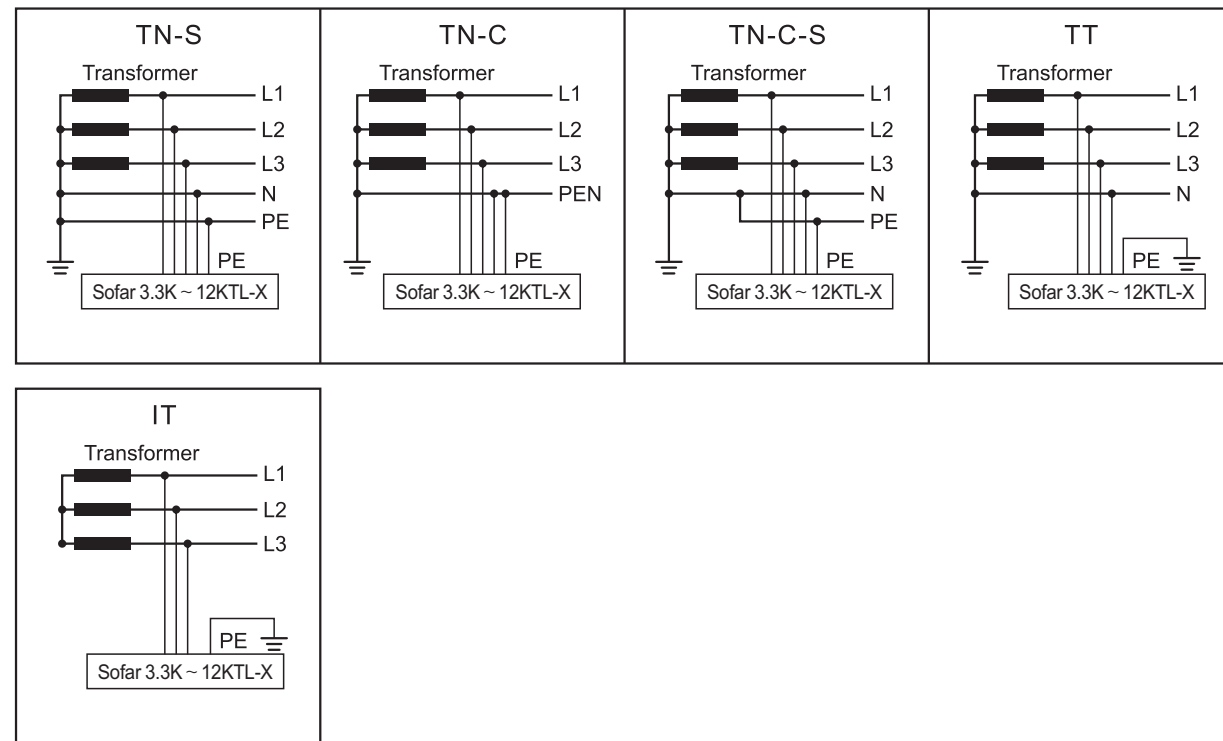

**2.2 Function description**

**Function module**

**A. Data transmission**

The inverter may be monitored remotely through an advanced communications system based on an RS485 serial interface, or remotely via the WIFI.

**B. Energy management unit**

**B.1 Remote switching on/off**

This control can be used to switch the inverter on/off through an external (remote) control.

**B.2 Feeding reactive power into the grid**

The inverter is able to produce reactive power and can therefore feed it into the grid through the setting of the phase shift factor. Feed-in management can be controlled directly by the grid company through a dedicated RS485 serial interface.

**B.3 Limiting the active power fed into the grid**

The inverter, if enabled can limit the amount of active power fed into the grid by the inverter to the desired value (expressed as a percentage).

**B.4 Self power reduction when grid over frequency**

When the grid frequency is over limited value, inverter will reduce output power which do good to the grid stability.

**B.5 Power reduction due to environmental conditions, input output voltage**

The power reduction value and the inverter temperature at which it occurs depend on the ambient temperature and on many operating parameters. Example: input voltage, grid voltage and power available from the photovoltaic field. The inverter can therefore reduce the power during certain periods of the day and according to the value of these parameters.

**C. Software update**

SD card is used for updating the firmware.

**2.3 Protection modules**

**A. Anti-islanding**

In the event of a local grid outage by the electricity company, or when the equipment is switched off for maintenance operations, the inverter must be physically disconnected safely, to ensure protection of people working on the grid, all in accordance with the relevant national standards and laws. To prevent possible islanding, the inverter is equipped with an automatic protective disconnection system called “Anti-Islanding”.

**B. RCMU**

Sofar inverters are equipped with a redundancy on the reading of the ground leakage current sensitive to all components of both direct and alternating current. Measurement of the ground leakage current is carried out at the same time and independently by 2 different processors: it is sufficient for one of the two to detect an anomaly to trip the protection, with consequent separation from the grid and stopping of the conversion process.

**C. Grid monitoring**

Continuous monitoring of the grid voltage to ensure the voltage and frequency values stay within operating limits.

**D. Inverter internal device protection**

The inverter has all kinds of internal protection to protect the device inside when grid or input DC side have abnormal situation.

**E. Ground fault protection**

This inverter must be used with panels connected with “floating” connections, that is, with positive and negative terminals without ground connections. An advanced ground fault protection circuit continuously monitors the ground connection and disconnects the inverter when a ground fault is detected. The ground fault condition is indicated by a red LED on the front panel.

# 3 Installation

## 3.1 Installation Process

Figure3-1 Installation flowchart

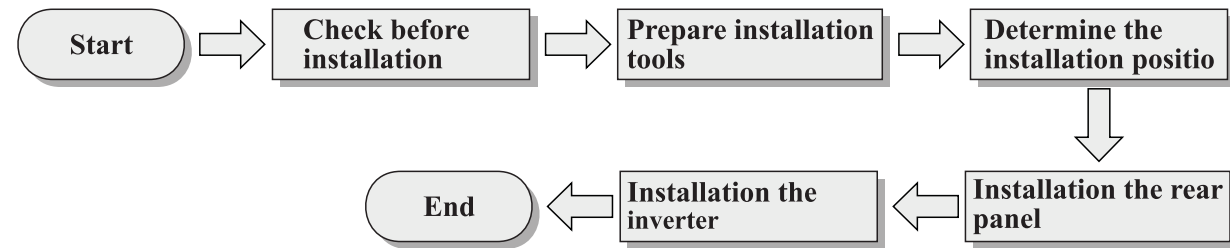

## 3.2 Checking Before Installation

### Checking Outer Packing Materials

Packing materials and components may be damaged during transportation. Therefore, check the outer packing materials before installing the inverter. Checking the surface of packing materials for damage, such as holes and cracks. If any damage is found, do not unpack the inverter and contact the dealer as soon as possible. You are advised to remove the packing materials within 24 hours before installing the inverter.

### Checking Deliverables

After unpacking the inverter, check whether deliverables are intact and complete. If any damage is found or any component is missed, contact the dealer.

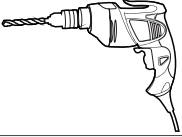
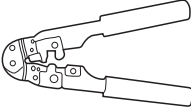
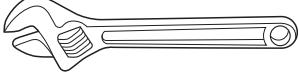

Table3-1 shows the components and mechanical parts that should be delivered





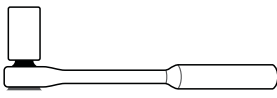
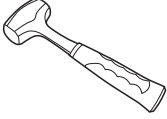
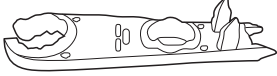
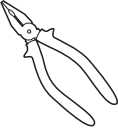
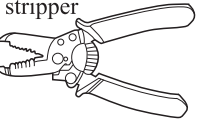

No.	Pictures	Quantity	Description
1		1PCS	Sofar 3.3K~12KTL-X
2		1PCS	Rear panel
3		2PCS	DC+ input terminal
4		2PCS	DC- input terminal
5		2PCS	Metal terminals secured to DC+ input power cables
6		2PCS	Metal terminals secured to DC- input power cables
7		3PCS	M6 Hexagon screws
8		6PCS	M8*80 Expansion bolts used to secure the rear panel to the wall
9		1PCS	AC Output connector
10		1PCS	6pin terminal blocks
11		1PCS	Manual
12		1PCS	The warranty card
13		1PCS	Certificate

### 3.3 Tools

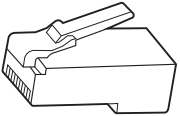
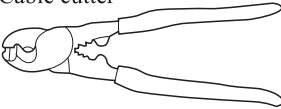
Prepare tools required for installation and electrical connections.

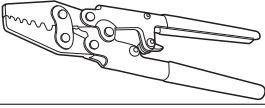
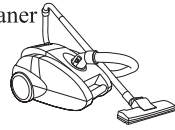
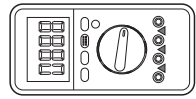
Table3-2 Shows the components and mechanical parts that should be delivered

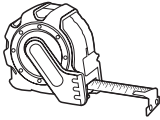
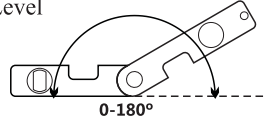
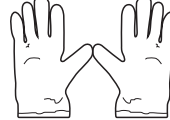
Tool	Model	Function
Hammer drill 	With a drill bit of $\Phi 8.0$	Used to drill holes on the wall
RJ45 crimping tool 	N/A	Used to prepare RJ45 connectors for Communications cables
Adjustable wrench 	With an open end of larger than or greater than 32 mm	Used to tighten expansion bolts
Flat-head screwdriver 	M4	<ul style="list-style-type: none"> <li>Used to tighten or loosen screws when installing AC power cables.</li> <li>Used to remove AC connectors from the Sofar 3.3K~12KTL-X.</li> </ul> Note: The torque screwdriver and flat-head screwdriver are alternative.
Socket wrench 	M5	Used to tighten ground bolts
Rubber mallet 	N/A	Used to hammer expansion bolts into holes
Removal tool 	N/A	Used to remove DC connectors from the Sofar 3.3K~12KTL-X
Diagonal pliers 	N/A	Used to cut and tighten cable ties
Wire stripper 	N/A	Used to peel cable jackets

Tool	Model	Function
	RJ45	2PCS
Cable cutter 	N/A	Used to cut power cables
Hexagon socket 	Diameter 2.0mm Diameter 5.0mm	Hexagon socket use to uninstall and install the front top cover and down cover.
Crimping tools 	N/A	Used to crimp power cables
Vacuum cleaner 	N/A	Used to clean up dusts after drilling holes
Multimeter 	N/A	Used to check grounding
Marker 	N/A	Used to mark signs
Measuring tape 	N/A	Used to measure distances
Level 	N/A	Used to ensure that the rear panel is properly installed
ESD gloves 	N/A	Operators wear ESD gloves when installing equipment.
Safety goggles 	N/A	Punch operator wearing
Anti-dust respirator 	N/A	Punch operator wearing



### 3.4 Determining the Installation Position

Determine an appropriate position for installing the Sofar 3.3K~12KTL-X. Comply with the following requirements when determining the installation position:

Figure 3-2 Installation position requirements

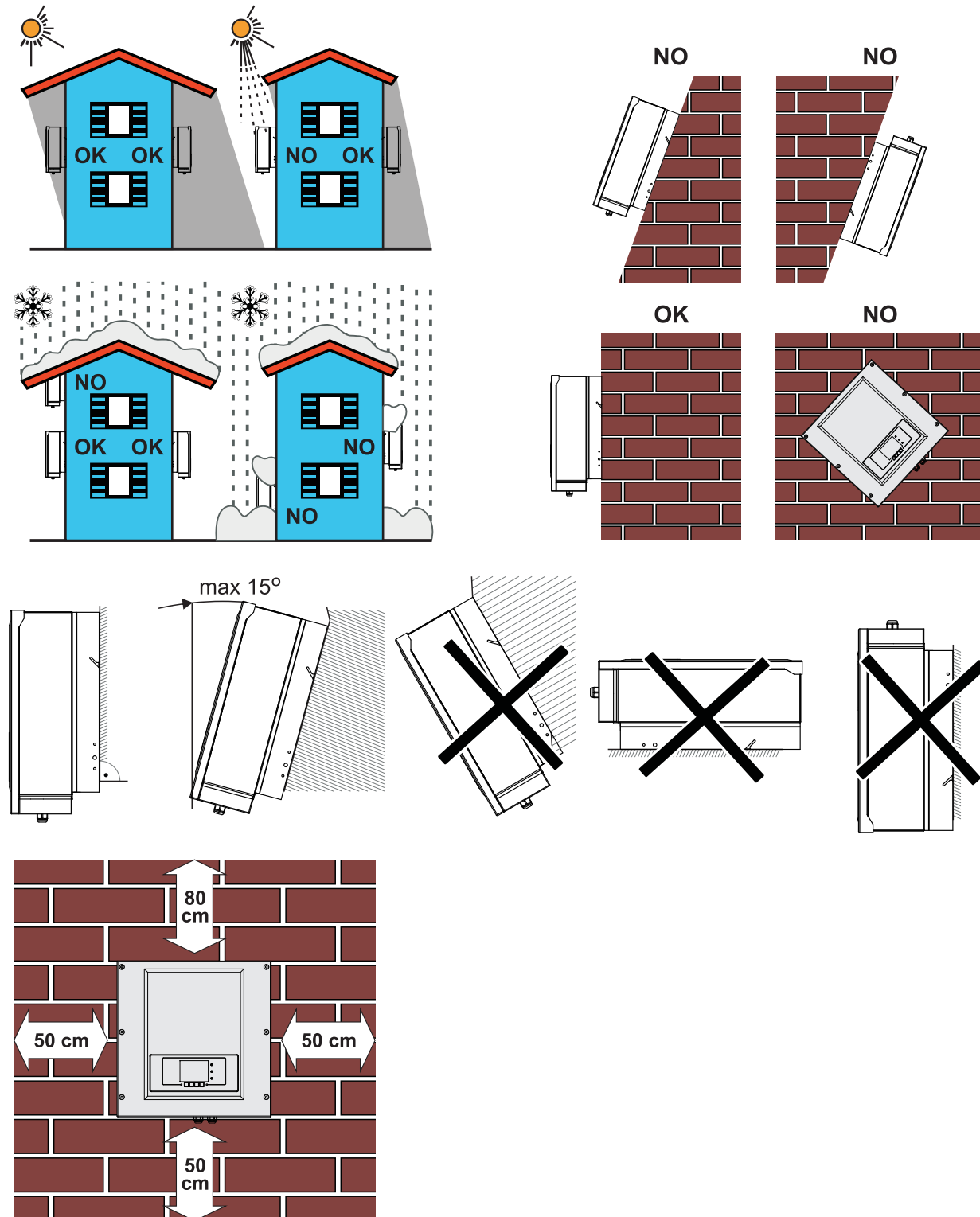

Minimum installation distance for Sofar 3.3K~12KTL-X

Figure 3-3 Many Sofar 3.3K~12KTL-X installation

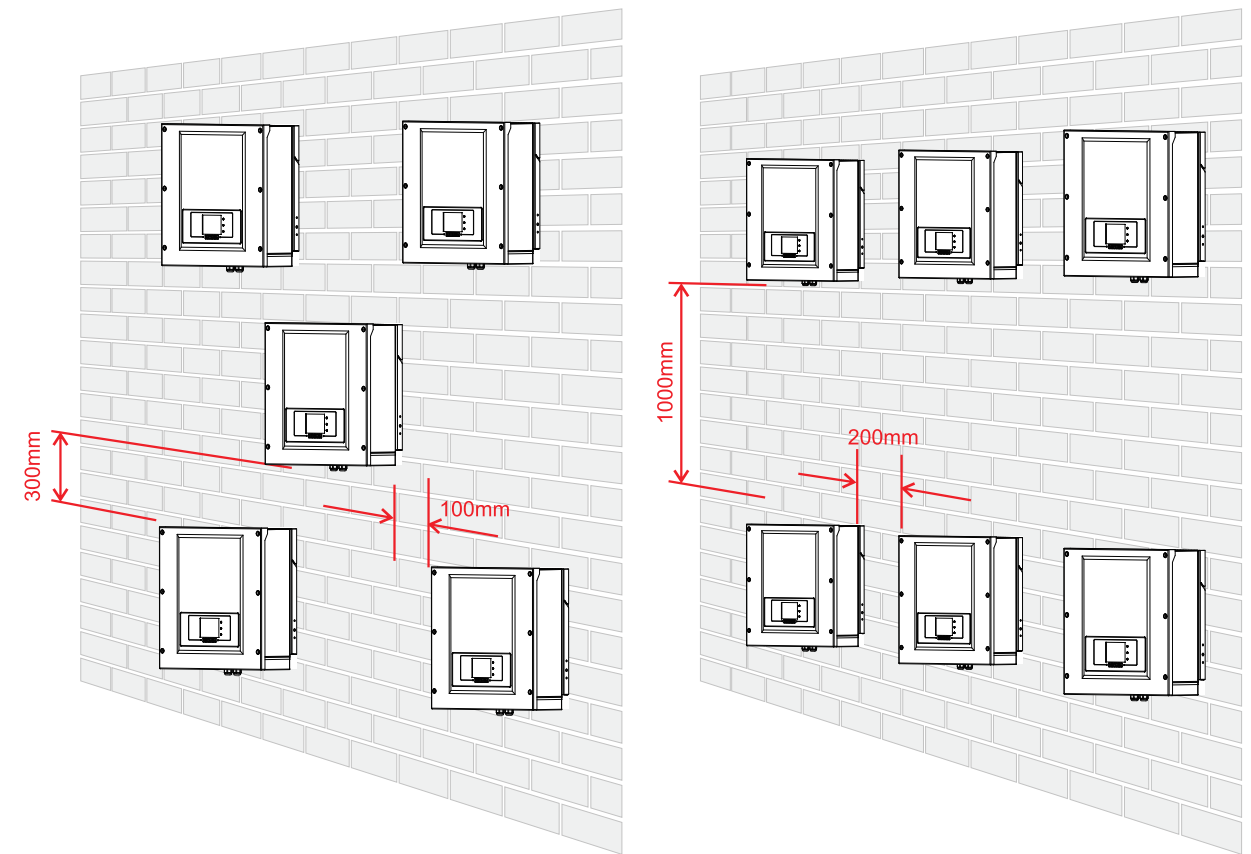

### 3.5 Installing the Sofar 3.3K~12KTL-X

**Step 1** To determine the position for drilling holes, level hole positions, and then mark the hole position by using a marker, use the hammer drill to drill hole on the wall. Keeping the hammer perpendicular to the wall, do not shake when drilling, so as not to damage the walls. If the aperture errors, need to reposition.

**Step 2** The expansion screw is vertically inserted into the hole, pay attention to expanding screw insertion depth (not too shallow).

**Step 3** Putting the rear panel on the wall, the rear panel is fixed by the nuts.

**Step 4** Putting the Sofar 3.3K~12KTL-X hook on the rear panel.

**Step 5** Using an M6 screw back and inverter bottom fastening, to ensure safety.

**Step 6** Putting the rear panel and inverter to lock together, In order to ensure the safety (the user can select lock according to the actual situation).

Figure 3-4

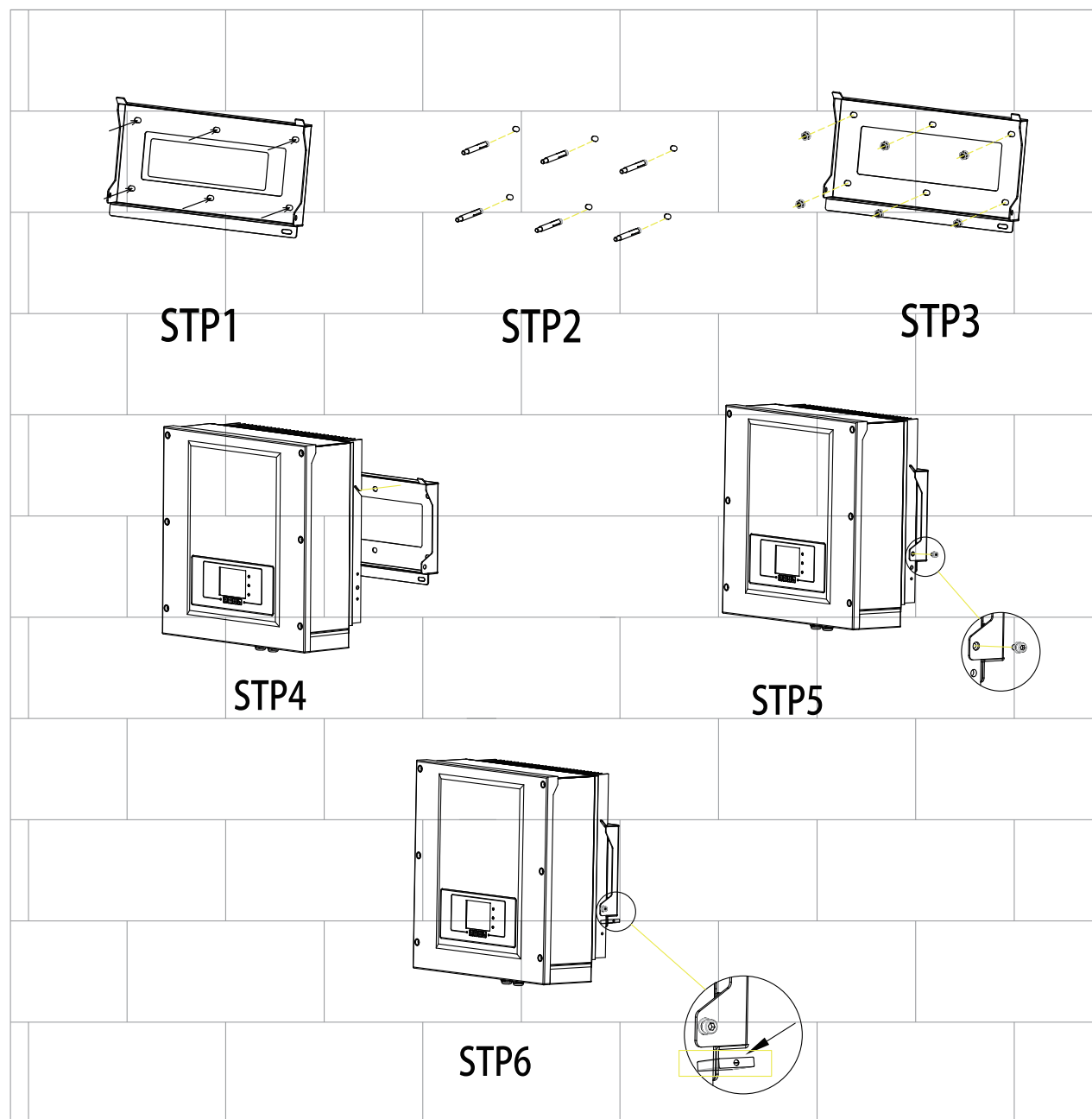

# 4 Electrical Connections

## 4.1 Electrical connection

Figure4-1 Shows the flowchart for connecting cables to the Sofar 3.3K~12KTL-X.

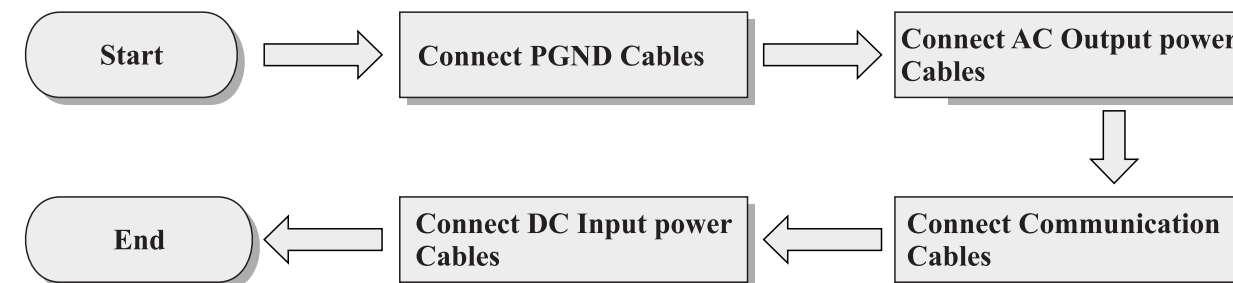

## 4.2 Connecting PGND Cables

Connect the Sofar 3.3K~12KTL-X to the grounding electrode using protection ground (PGND) cables for grounding purposes.

	<b>The inverter is transformerless, Requires The positive pole and the negative pole of the PV array are not grounded, Otherwise it will cause inverter failure, In the PV power generation system, all non current carrying metal parts(such as: Bracket, inverter shell) should be connected to earth.</b>
<b>Attention</b>	

**Note:**

- Good grounding for the Sofar 3.3K~12KTL-X can help resist the impact of the surge voltage and improve the EMI performance. First connect the PGND cable before connecting the AC power cable, DC power cable, and communication cable.  
For the system with one Sofar 3.3K~12KTL-X, connect the PGND cable to the ground. For the system with multiple Sofar 3.3K~12KTL-X, connect the PGND cables of all Sofar 3.3K~12KTL-X to the grounding electrode using equipotential bonding.
- If the installation location is near the ground, first connect the PGND cable to the ground before installing the Sofar 3.3K~12KTL-X on the wall.

Figure4-2 Ground terminal composition

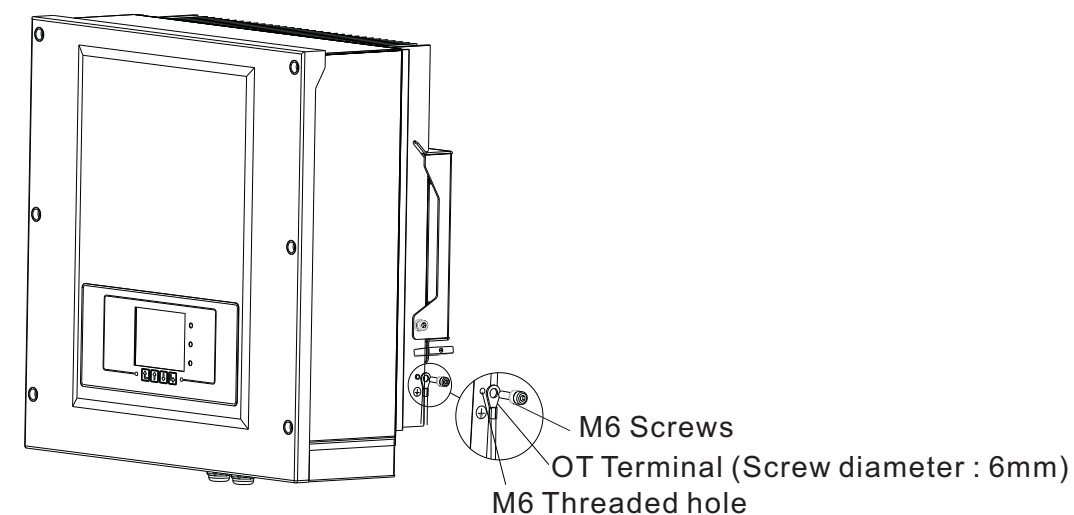

### 4.3 Connecting AC Output Power Cables

Connect the Sofar 3.3K~12KTL-X to the AC power distribution frame (PDF) or electrical grid using AC output power cables.

 <b>Caution</b>	<ul style="list-style-type: none"> <li>It is not allowed for several inverters to use the same circuit breaker.</li> <li>It is not allowed to connect loads between inverter and circuit breaker.</li> </ul>
---	--

**Context**

All the AC output cables used for the inverters are outdoor five-core cables. To facilitate the installation, use flexible cables. Table 4-1 lists the recommended specifications for the cables and the breakers.

Table4-1

Type	Sofar 3.3KTL-X*	Sofar 4.4KTL-X	Sofar 5KTL-X (Australia)*	Sofar 5.5KTL-X	Sofar 6.6KTL-X	Sofar 8.8KTL-X	Sofar 11KTL-X	Sofar 12KTL-X
Cable(Copper)	2.5-6mm <sup>2</sup>	2.5-6mm <sup>2</sup>	2.5-6mm <sup>2</sup>	2.5-6mm <sup>2</sup>	2.5-6mm <sup>2</sup>	4-6mm <sup>2</sup>	4-6mm <sup>2</sup>	4-6mm <sup>2</sup>
Breaker	10A	10A	10A	10A	16A	16A	20A	25A

The models marked with “\*” should be available only for some designated countries.

Note: For the sake of safety, please make sure to use correctly sized cables, otherwise the current makes the cable overheat or overload, even cause a fire.

**Multi core copper wire**

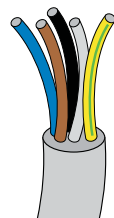

The cross-section of the AC line conductor must be sized in order to prevent unwanted disconnections of the inverter from the grid due to high impedance of the line that connects the inverter to the power supply point; In fact, if the impedance is too high, it causes an increase in the AC voltage that, on reaching the limit set by the country of installation, causes the inverter to switch off Table4-2.

Table4-2

The cable cross-sectional area(mm <sup>2</sup> )	The maximum length(m)							
	Sofar 3.3KTL-X*	Sofar 4.4KTL-X	Sofar 5KTL-X (Australia)*	Sofar 5.5KTL-X	Sofar 6.6KTL-X	Sofar 8.8KTL-X	Sofar 11KTL-X	Sofar 12KTL-X
2.5	50	50	40	40	33	/	/	/
4	80	80	60	60	50	40	32	26
6	120	120	96	96	80	60	48	40

The models marked with “\*” should be available only for some designated countries.

**Procedure**

Sofar 3.3K~12KTL-X is a three-phase output inverter, strictly comply with local grid-connection requirements and safety standards.

**Step 1** Remove the insulation layer of an appropriate length according to figure 4-3, then insert the AC output cable though the PG waterproof cable gland.

Figure4-3 AC Output Cable schematic diagram

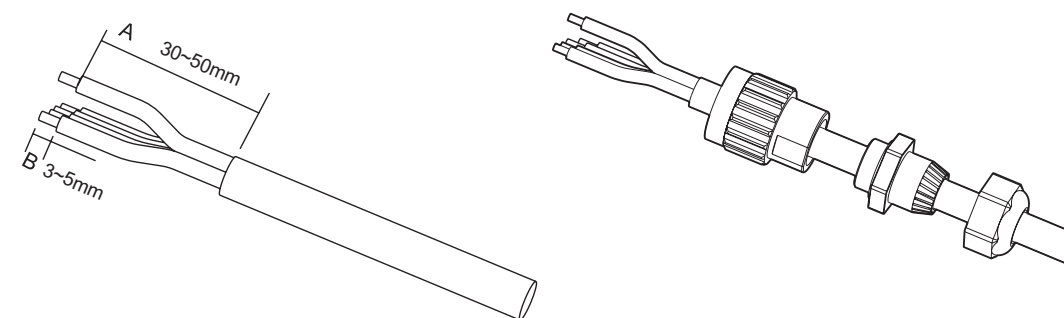

**Step 2** Connecting the AC output power cable: The AC output cable(R,S,T,N and PE) is connected to the terminal block, as shown in figure 4-4.

Figure4-4 Cable connection schematic diagram

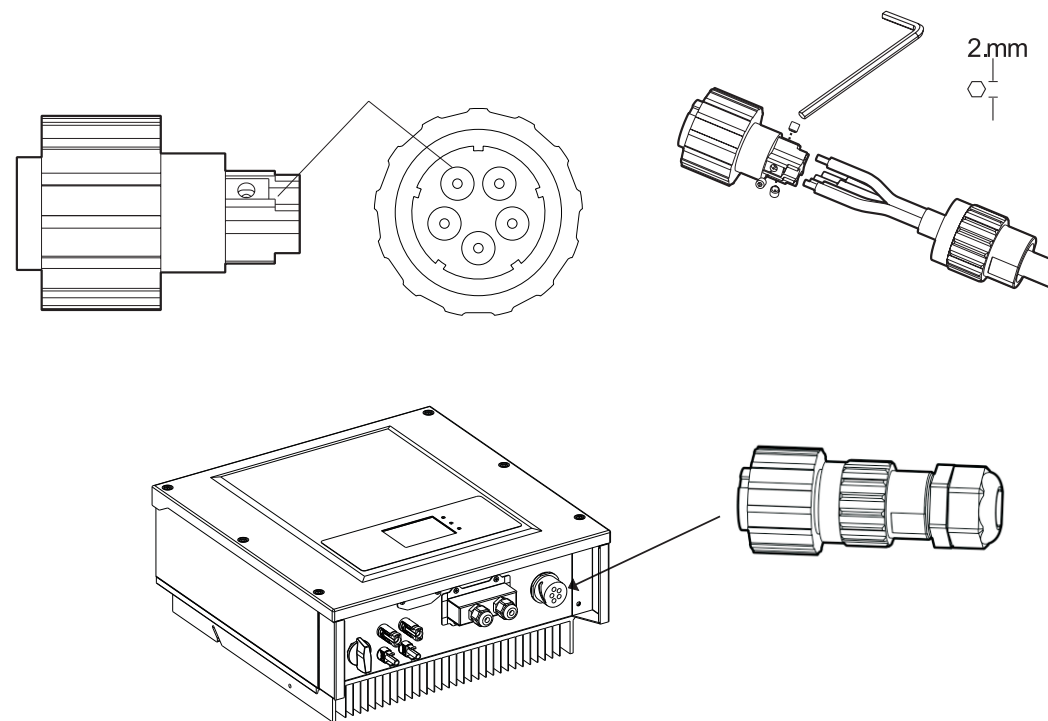

## 4.4 Connecting Communications Cables

### Connecting Communications Port

Sofar 3.3K~12KTL-X has two communication interface, RS485 interface, WIFI interface, as shown in the following figure:

Figure 4-5 WIFI/RS485 location map

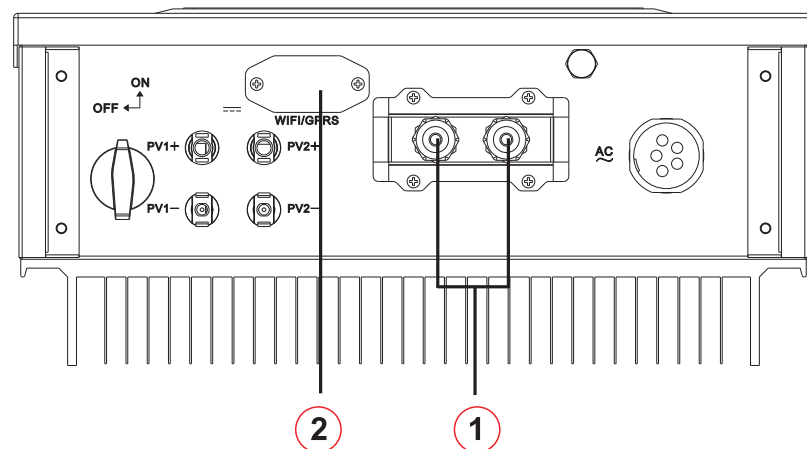

1. RS485 interface 2. WiFi/GPRS

### Connecting RS485 Communications Cables

By the RS485 communication line, connecting Sofar 3.3K~12KTL-X to communication equipment (such as data acquisition, PC terminal).

You are recommended to use 24 AWG outdoor shielded network cables with the internal resistance less than or equal to 1.5 ohms/10 m and external diameter of 4.5 mm to 7.5 mm as RS485 communications cables.

A waterproof RJ45 connector has six parts: plug, screw nut, seals, housing, sealing plug and cable screw nut, as shown as follow.

Figure 4-6 Waterproof RJ45 connector composition

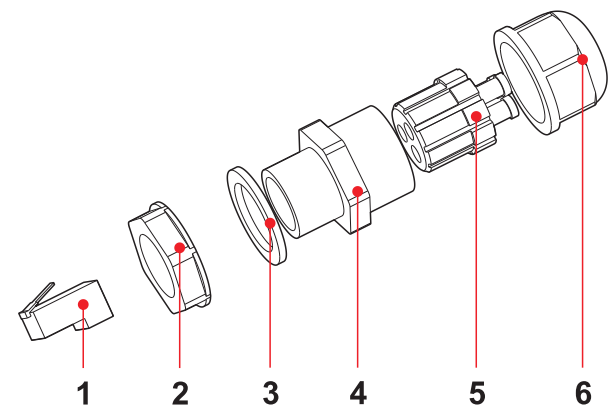

1. Plug 2. Screw nut 3. Seals 4. Housing 5. Sealing Plug 6. Cable Screw nut

When routing communications cables, ensure that communications cables are separated from power cables and away from interference sources to prevent communication interruptions.

### Procedure

**Step 1** Remove the insulation layer of an appropriate length from the shielded network cable using a wire stripper.

**Step 2** Open Sofar 3.3K~12KTL-X lower cover and insert the shielded network cable into the cable screw nut, seals, screw nut.

**Step 3** Connect the stripped network cable to corresponding pins on the plug, as shown as follow.

Figure 4-7 RS485 Connecting Communications Cables(1)

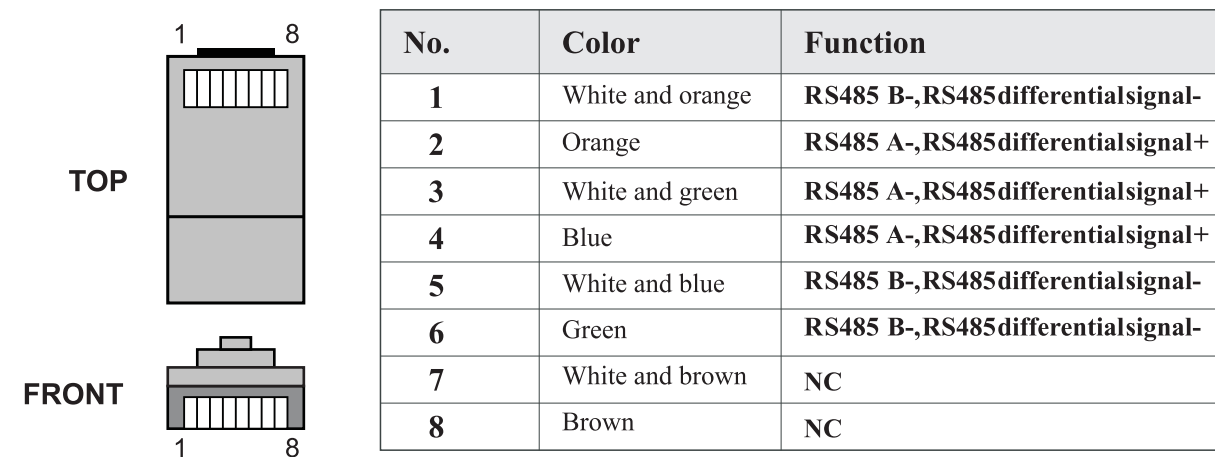
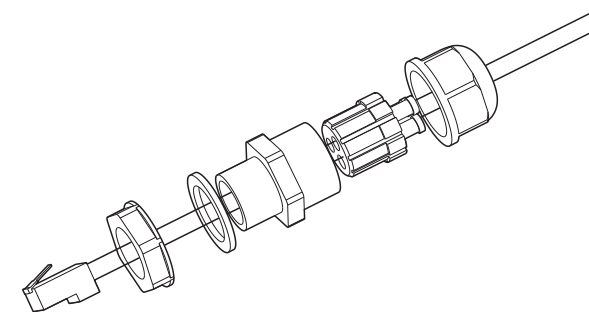

Figure 4-8 RS485 Connecting Communications Cables(2)



**Step 4** Crystal plug with RJ45 crimping tool.

**Step 5** Insert the plug into the RS485 port on the Sofar 3.3K~12KTL-X.

**Step 6** Insert sealing plug into housing.

Figure 4-9 RS485 Connecting Communications Cables(3)

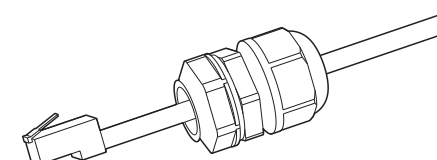



## Communications Port Description

This topic describes the functions of the RS485 and WIFI ports.

### RS485

By RS485 interface, transfer the inverter power output information, alarm information, operation state to the PC terminal or local data acquisition device, then uploaded to the server (such as TERMINAL).

#### 1. USB-RS485

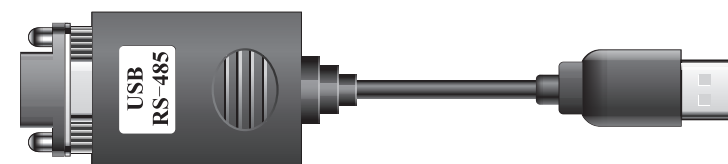

#### 2. TERMINAL

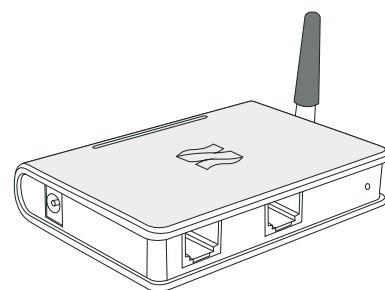

If only one Sofar 3.3K~12KTL-X is used, use a communication cable with waterproof RJ45 connectors, and choose either of the two RS485 ports.

Figure 4-10 A single Sofar 3.3K~12KTL-X connecting Communications

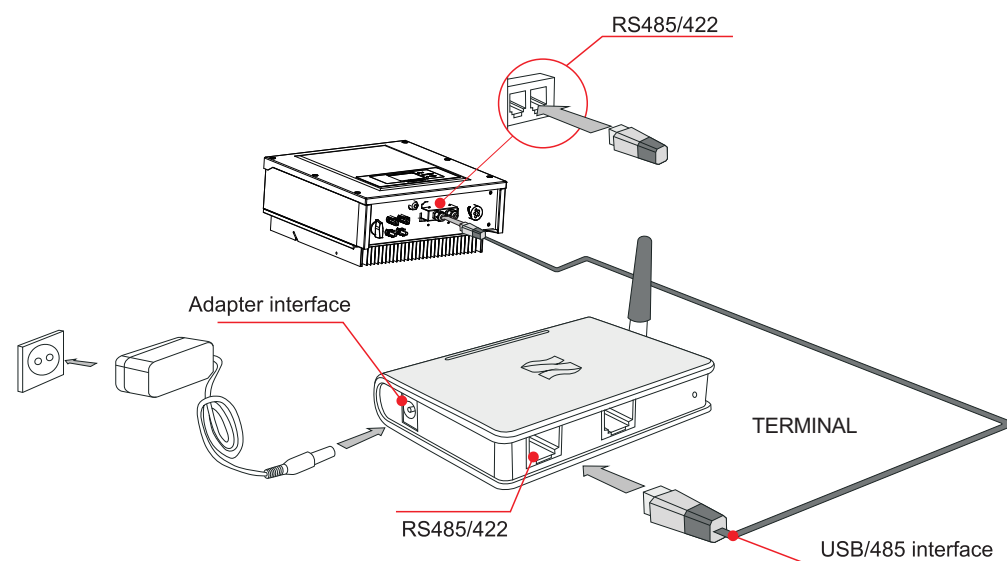

If multiple Sofar 3.3K~12KTL-X are used, connect all Sofar 3.3K~12KTL-X in daisy chain mode over the RS485 communication cable.

Figure 4-11 Multi Sofar 3.3K~12KTL-X connecting Communications

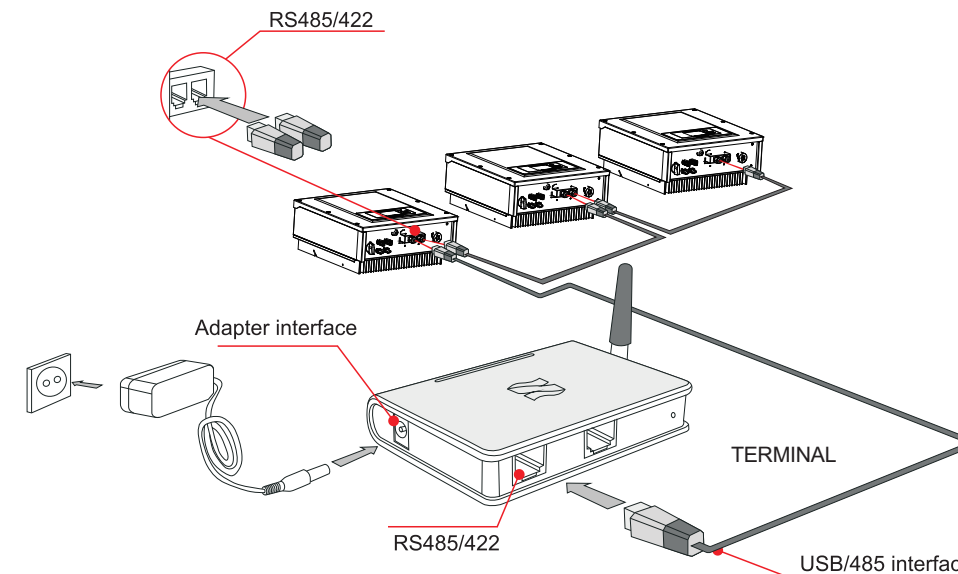

According to the manufacturers to provide SN number can register remote monitoring of Sofar 3.3K~12KTL-X through <http://www.solarmanpv.com>.

### WiFi/GPRS

By the WIFI interface, transfer the inverter power output information, alarm information, operation state to the PC terminal or local data acquisition device, then uploaded to the server (such as TERMINAL).

According to the manufacturers to provide SN number can register remote monitoring of Sofar 3.3K~12KTL-X through <http://www.solarmanpv.com>.

Figure 4-12 Connect multiple Wifi to wireless router

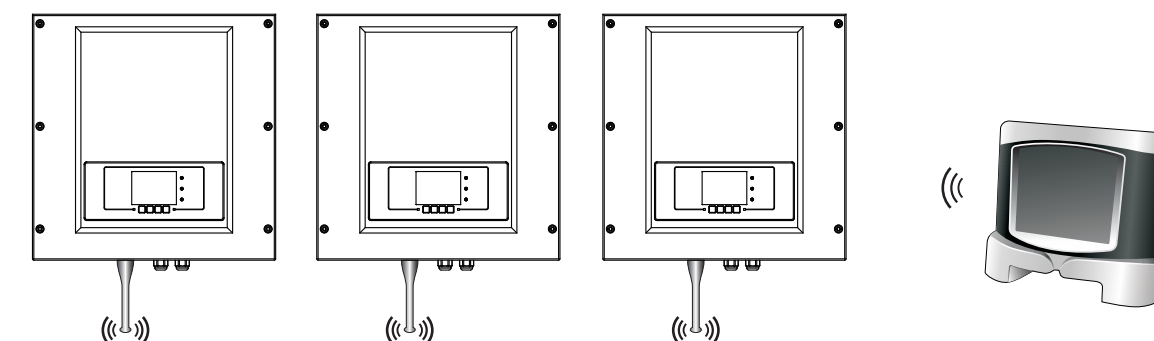

#### Note

- The length of the RS485 communication cable should be less than 1000 m.
- The distance between WIFI and Ethernet router should be less than 100m.
- If multiple Sofar 3.3K~12KTL-X are connected to the monitoring device over an RS485/RS232 converter, a maximum of 31 inverter can be connected in a daisy chain.
- If multiple Sofar 3.3K~12KTL-X are connected to a TERMINAL, a maximum of 31 Sofar 3.3K~12KTL-X can be connected in three daisy chains.



## Connecting to DRED(Demand Response Enabling Device) ----only Australia

Step1: Open the bottom cover, the wire through the waterproof joint and locks the terminal

Step2: Insert the terminal and lock the screw

Step3: Refer to "6.3 main interface "setting to enable the function

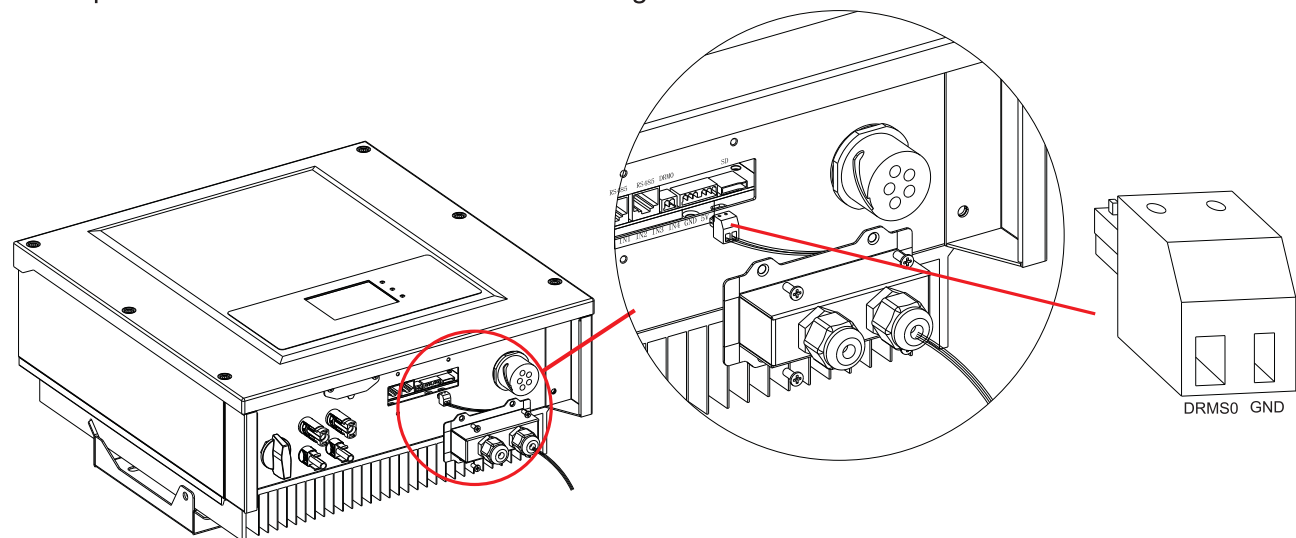

## 4.5 Connecting DC Input Power Cables

Connect the Sofar 3.3K~12KTL-X to PV arrays over DC input power cables.

Input mode selection : Sofar 3.3K~12KTL-X has 2 MPPT, The two MPPT can run independently, but also can be operated in parallel, According to the system design, the user can choose the mode of MPPT operation.

### Independent mode (default):

If the two MPPT panels is independent, the input mode should be set as "independent mode".

The setting method is introduced at chapter 6.3.

### Parallel mode :

If the two MPPT panels is paralleled together by combiner, the input mode should be set as "parallel mode".

The setting method is introduced at chapter 6.3.





#### Note

According to the inverter type, choose the inverter accessories (cables, fuse holder, fuse, breaker etc.), Sofar inverter with PV array should be excellent performance, reliable quality. The open circuit voltage of PV must be less than Maximum DC input voltage of Sofar inverter, The output voltage of the solar array must be consistent with the MPPT voltage range.

The positive and negative poles of the panel to inverter need to connect fuse separately. The electric wire should choose PV cable,from the junction box to the inverter, line voltage drop is about 1~2%, The inverter is installed in the PV bracket, which saves the cable and reduce the DC loss.

 <b>Note</b>	<ul style="list-style-type: none"> <li>• Check polarity of PV array, to ensure the correct wiring of PV array;</li> <li>• Please don't put the positive or negative of the PV array connect to earth.</li> </ul>
--	--

 <b>Danger</b>	<ul style="list-style-type: none"> <li>• PV modules generate electric energy when exposed to sunlight and can create an electrical shock hazard. Therefore, when connecting DC input power cable, cover PV modules by using opaque cloth.</li> <li>• Before performing electrical connections, ensure that voltages of the DC cables should be within the safe voltage range, that is, lower than 60 V DC, and the DC SWITCH is OFF. Otherwise, the high voltage may result in fatal danger.</li> </ul>
--	---

 <b>Caution</b>	<p><b>Ensure that the following conditions are met. Otherwise, fire accident may occur.</b></p> <ul style="list-style-type: none"> <li>• PV modules connected in series in each PV array are of the same specifications.</li> <li>• The open-circuit voltage of each PV array is always lower than or equal to 1000 V DC.</li> <li>• The output power of each PV array is always less than or equal to the maximum input power of the Sofar 3.3K~12KTL-X.</li> <li>• The positive and negative terminals of PV arrays connect to the positive and negative DC input terminals respectively.</li> </ul>
---	--

### Context

Table 4-3 Recommended DC input cable specifications

Cross-Sectional Area (mm)		External Cable Diameter(mm)
Range	Recommended Value	
4.0~6.0	4.0	4.5~7.8

DC input connectors are classified into positive and negative connectors, as shown in Figure 4-13 and Figure 4-15.

Figure 4-13 Positive connector composition

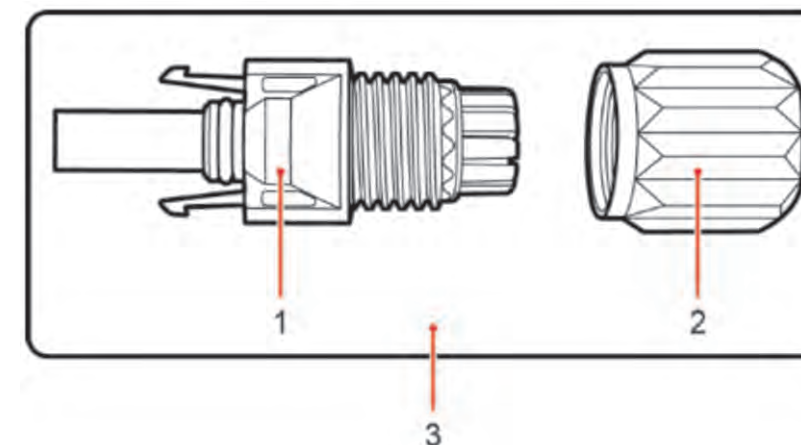

1. Housing 2. Cable gland 3. Positive connector

Figure 4-14 Negative connector composition

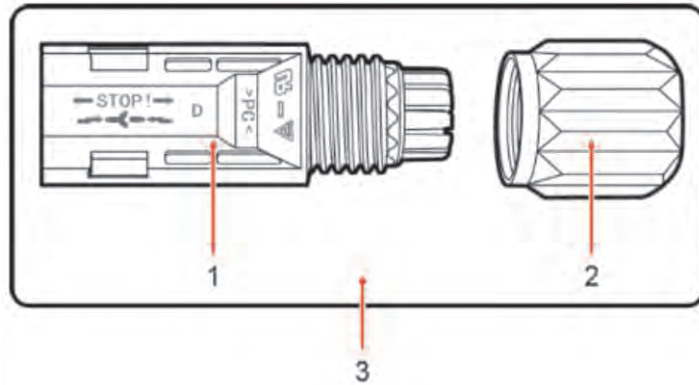

1. Housing 2. Cable gland 3. Negative connector



**Note**

Positive and negative metal terminals are packed with positive and negative connectors respectively. Separate the positive from negative metal terminals after unpacking the Sofar 3.3K~12KTL-X to avoid confusing the polarities.

**Procedure**

**Step 1** Remove cable glands from the positive and negative connectors.

**Step 2** Remove the insulation layer with an appropriate length from the positive and negative power cables by using a wire stripper as show in Figure 4-16.

Figure 4-15 Connecting DC input power cables

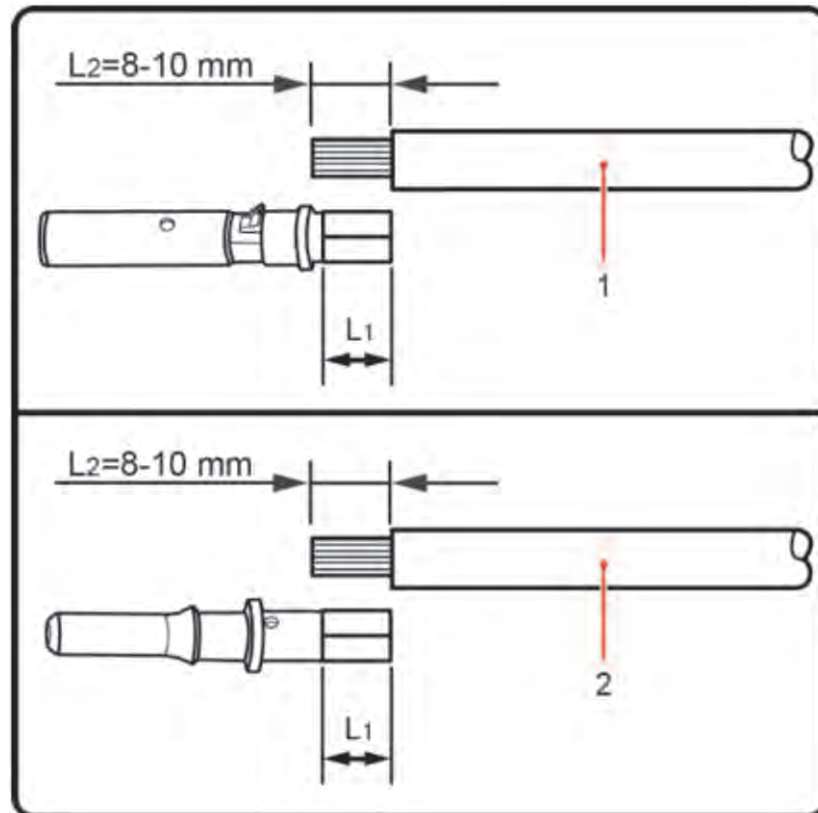

1. Positive power cable 2. Negative power cable



**Note**

L2 is 2 to 3 mm longer than L1.

**Step 3** Insert the positive and negative power cables into corresponding cable glands.

**Step 4** Insert the stripped positive and negative power cables into the positive and negative metal terminals respectively and crimp them using a clamping tool. Ensure that the cables are crimped until they cannot be pulled out by force less than 400 N, as shown in Figure 4-17.

Figure 4-16 Connecting DC input power cables

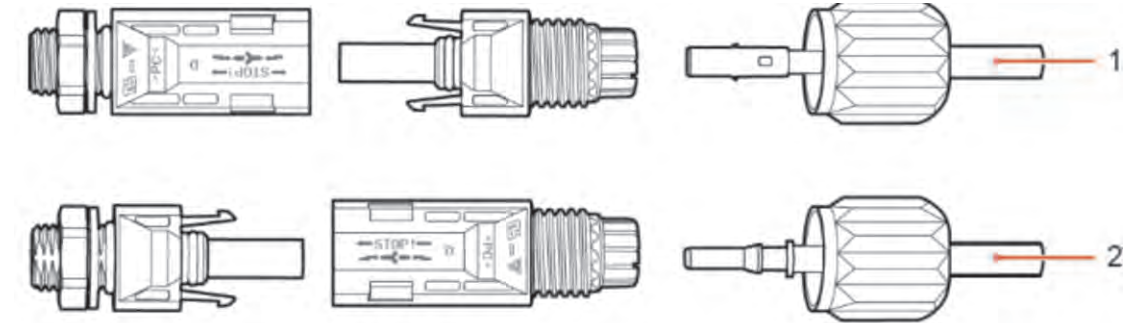

1. Positive power cable 2. Negative power cable

**Step 5** Insert crimped power cables into corresponding housings until you hear a "click" sound. The power cables snap into place.

**Step 6** Reinstall cable glands on positive and negative connectors and rotate them against the insulation covers.

**Step 7** Insert the positive and negative connectors into corresponding DC input terminals of the Sofar 3.3K~12KTL-X until you hear a "click" sound, as shown in Figure 4-17.

Figure 4-17 Connecting DC input power cables

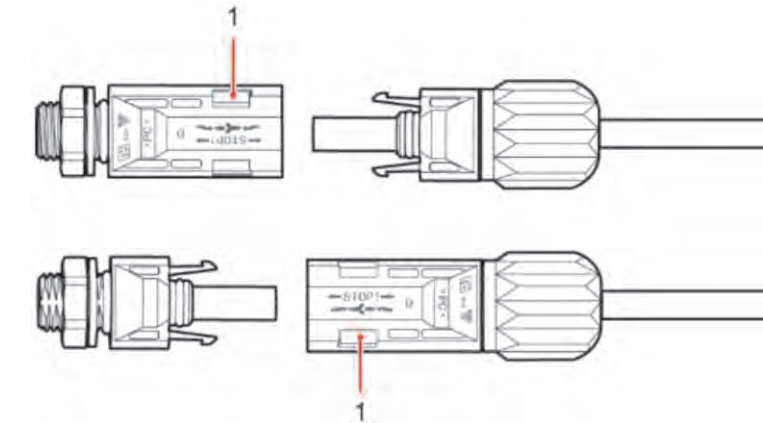

**Follow-up Procedure**

To remove the positive and negative connectors from the Sofar 3.3K~12KTL-X, insert a removal wrench into the bayonet and press the wrench with an appropriate strength, as shown in Figure 4-18.



Before removing the positive and negative connectors, ensure that the DC SWITCH is OFF.