

# HYD 3000/3600/4000/5000/6000-ES

## User Manual



2018-10-13  
Version V1.1

# CONTENT

1. HYD-ES inverter Introduction.....	3
2. Safety Notes.....	4
2.1. Safety Notes.....	4
2.2. Installation and Maintenance Notes.....	4
2.3. Signs on the inverter.....	5
3. Installation.....	7
3.1. Product Overview.....	7
3.2. Packing List.....	8
3.3. Installation Environment.....	8
3.4. Installation Tools.....	9
3.5. Installation Position.....	10
3.6. Mount HYD-ES inverter.....	11
4. Electrical Connection.....	12
4.1. Battery Connection.....	13
4.2. PV Connection.....	13
4.3. CT / CAN / RS485 / NTC connection.....	15
4.4. Grid Connection.....	17
4.5. Critical Load Connection (EPS function).....	18
5. Buttons and indicator lights.....	19
5.1. Buttons:.....	19
5.2. Indicator lights and status of HYD-ES inverter.....	19
6. Operation.....	20
6.1. Double Check.....	20
6.2. First Time Setup (IMPORTANT!).....	20
6.3. Commissioning.....	23
6.4. Menu.....	23
6.4.1. Basic setting.....	24
6.4.2. Advanced setting.....	31
6.4.3. Event List.....	34
6.4.4. System information interface.....	34
6.4.5. Energy Statistic.....	35
6.4.6. Software upgrade.....	36
7. Technical Data.....	37
8. Troubleshooting.....	39

# 1. HYD-ES inverter Introduction

The HYD-ES hybrid inverter is used in PV system with battery storage.

Energy produced by the PV system will be optimized for maximum self-consumption.

The HYD-ES inverter can work in auto or time-of-use (TOU) mode, charge / discharge the battery when needed. In auto mode, the HYD-ES inverter will charge surplus PV energy into the battery & discharge battery to supply power to local load when PV energy is not enough.

In case of blackout, HYD-ES inverter can work in Emergency Power Supply (EPS) mode. HYD-ES inverter will utilize power from PV panels & energy stored in the battery to supply power to critical load.

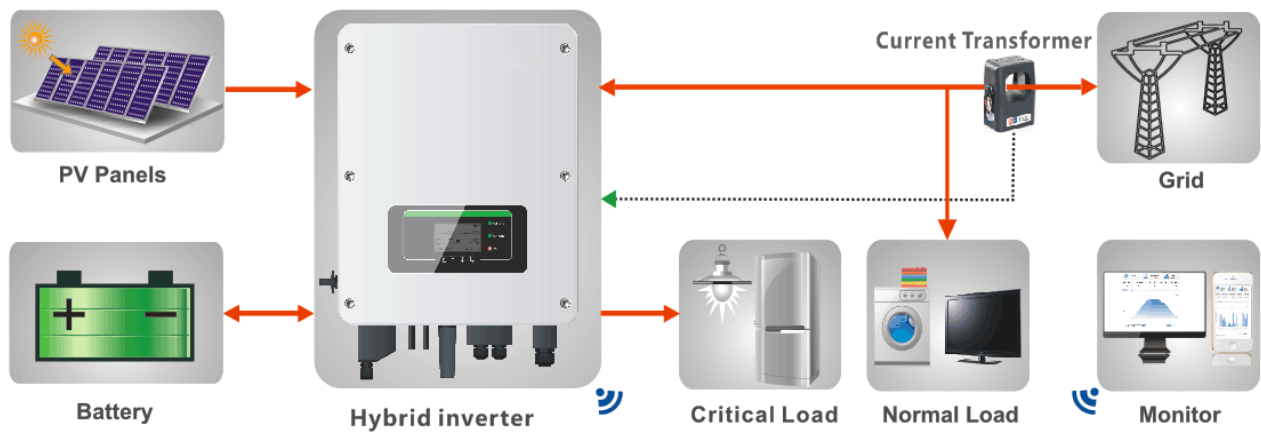

Fig. 1 HYD-ES inverter schematic diagram

## 2. Safety Notes

Before installation, please make sure you read & understand this manual. The HYD-ES inverter strictly comply with safety rules of design and testing. During the installation, operation and maintenance, operators should abide by local safety regulations. Improper operation may cause an electric shock or damage the equipment and properties.

### 2.1. Safety Notes

- ✧ Electrical installation and maintenance must be carried out by competent electricians according to local regulations.
- ✧ HYD-ES inverter can only be installed by qualified electrician, and only those who have appropriate accreditation, as required by local authority.
- ✧ Do NOT put explosives or flammable materials, e.g. gasoline, kerosene, diesel, oil, wood slab, cotton, or rag close to batteries or HYD-ES inverter.
- ✧ Disconnect AC connection first, then disconnect battery & PV(PV1&PV2), then wait at least 5 minutes (discharge capacitors) before maintenance to prevent electric shock.
- ✧ HYD-ES inverter shall be disconnected completely (BAT, PV & AC) while being maintained.
- ✧ HYD-ES inverter can be very hot during working. Switch off HYD-ES inverter & wait HYD-ES inverter to cool down before maintenance.
- ✧ Keep children away from batteries & HYD-ES inverter.
- ✧ It's NOT allowed to open the front cover of HYD-ES inverter. This will void the product warranty.
- ✧ HYD-ES inverter damaged by improper installation/operation is NOT covered by the product warranty.





### 2.2. Installation and Maintenance Notes





- ✧ The battery has been charged more than 60% before being delivered and shall be prevented from short circuit during transportation and installation.
- ✧ HYD-ES inverter/batteries shall be placed in a well-ventilated place. Do not put the HYD-ES inverter/batteries in an airtight or badly ventilated place or cabinet. This can be very harmful to system performance & service life.
- ✧ Keep HYD-ES inverter/batteries away from direct sunshine. Don't put HYD-ES inverter/batteries close to a furnace or fire. The can lead battery to leak even explode.
- ✧ The current capacity of DC power cables (from battery to inverter) should be at least 90A. Use short DC power cables to avoid high voltage drop & power loss.
- ✧ Use a multimeter to check the batter voltage & polarity before switching ON batteries. Make sure connections are correct according to this manual.
- ✧ Use a multimeter to check the PV voltage & polarity before switching ON PV isolator. Make sure connections are correct according to this manual.
- ✧ If you want to store the batteries without using them, they should be disconnected from HYD-ES inverter, and be kept in a cool, dry, and ventilated environment.

- ✧ Battery maintenance operators shall have the knowledge and technical skill for battery maintenance;
- ✧ All batteries connected in parallel should be of the same model and have same firmware version. This is a design issue needs to be considered by designer/installer, particularly when replacing batteries or modifying an existing energy storage system.
- ✧ HYD-ES inverter is transformer-less, therefore the positive pole and negative pole of the PV array are NOT grounded. Otherwise it will cause inverter failure. In the PV system, all non-current carrying metal parts (such as: PV module frame, PV rack, combiner box enclosure, inverter enclosure) should be connected to earth.
- ✧ Warning: Do not disassemble or break the battery. Its electrolyte can be toxic and damage your skin and eyes.
- ✧ Warning: follow the following rules during battery installation/maintenance.
  - a) Take off your watch, ring, and other metal objects.
  - b) Only use tools with insulated handles.
  - c) Wear rubber gloves and shoes.
  - d) Do not put tools or metals above the battery.
  - e) Switch off HYD-ES inverter & batteries before connecting / disconnecting battery terminals.
  - f) Battery positive/negative poles should be isolated from ground.

## 2.3. Signs on the inverter

There are some symbols which are related to security on the inverter. Please read and understand the content of the symbols before system installation.

	<p>This symbol indicates a hazardous situation which could result in injuries, if not avoided.</p>
	<p>Risk of Electric Shock and wait at least 5 mins after switching OFF HYD-ES inverter.</p>
	<p>Be careful of high voltage and electric shock.</p>
	<p>Be careful of hot surface.</p>
	<p>Comply with the Conformity Europeanness (CE) certification.</p>

	<p>Earth terminal.</p>
	<p>Please read this manual before installing HYD-ES inverter.</p>
	<p>This indicates the degree of protection of the equipment according to IEC standard 70-1 (EN 60529 June 1997).</p>
	<p>Positive pole and negative pole of the DC voltage (PV &amp; Battery).</p>
	<p>This side up, HYD-ES inverter must always be transported, handled and stored in such a way that the arrows always point upwards.</p>

# 3. Installation

## 3.1. Product Overview

HYD-ES inverter is 100% strictly inspected before package and delivery. It is forbidden to put the HYD-ES inverter upside down during delivery.

	<b>CAUTION</b>
	Please check the product package and fittings carefully before installation.

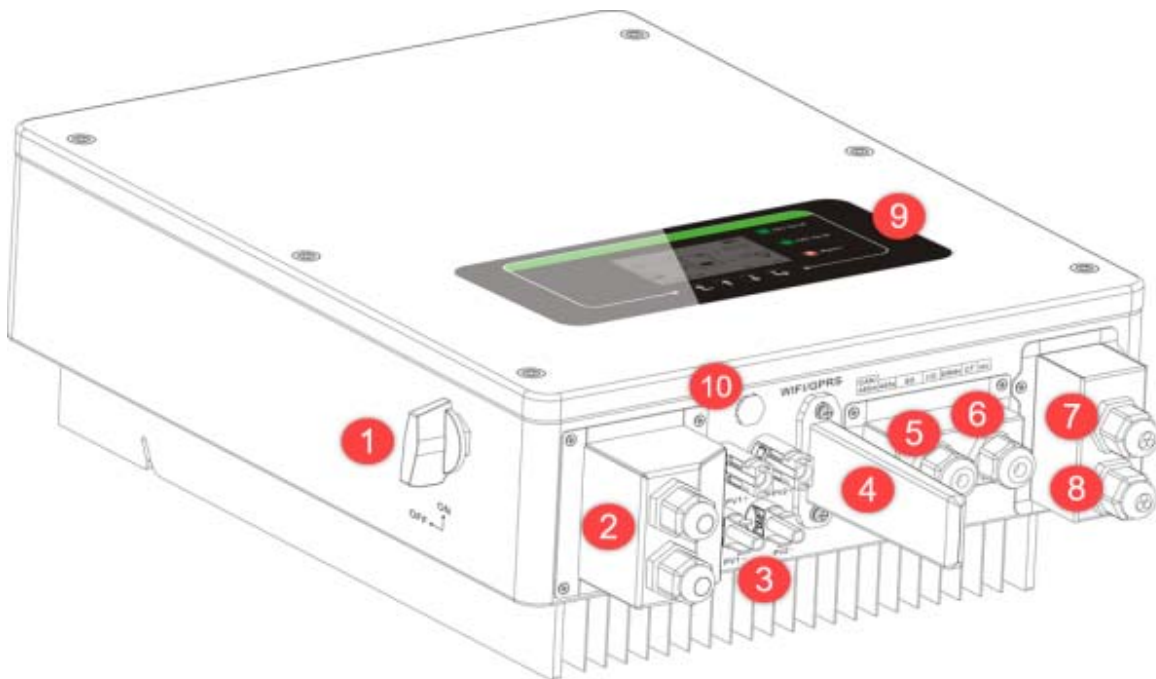

Fig. 2 HYD-ES inverter overview

1	DC switch	6	Current transformer port
2	Battery input terminals	7	Load connection port
3	PV input terminals	8	Grid connection port
4	Wi-Fi/GPRS stick	9	LCD
5	BMS communication port	10	breather valve

### 3.2. Packing List

Inspect the package and fittings carefully before installation. You should have the following fittings:











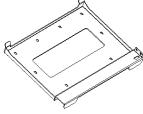

 <p>Mounting Bracket × 1</p>	 <p>AC terminal × 6</p>	 <p>M5 screw × 2</p>	 <p>Battery terminal × 2</p>
 <p>M6 flat washer × 8</p>	 <p>Expansion Bolts × 8</p>	 <p>Terminal cap × 4</p>	 <p>CT terminal × 2</p>
 <p>Current Transformer × 1</p>	 <p>User Manual × 1</p>	 <p>Warranty card × 1</p>	 <p>Quality Certificate × 1</p>
 <p>Communication cable × 1</p>	 <p>PV+ input terminal × 2</p>	 <p>PV- input terminal × 2</p>	 <p>NTC × 1 (Long-3M)</p>

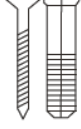
Fig. 3 Accessories of HYD-ES inverter

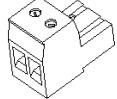
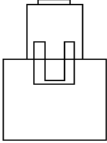



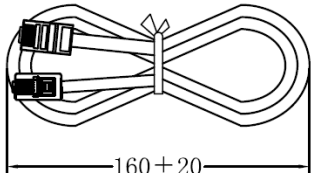

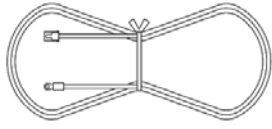



### 3.3. Installation Environment

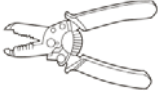

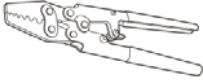
- ✧ Choose a dry, clean, and tidy place, convenient for installation
- ✧ Ambient temperature range: -25°C ~ 60°C
- ✧ Relative humidity: 0 ~ 100% (non-condensed)
- ✧ HYD-ES inverter shall be installed in a well-ventilated place
- ✧ No flammable or explosive materials close to HYD-ES inverter
- ✧ The AC overvoltage category of HYD-ES inverter is category III
- ✧ Maximum altitude: 2000m

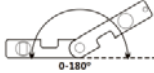

### 3.4. Installation Tools

The following tools shall be prepared before installation:

No.	Tool	Model	Function
1		Hammer drill Recommend drill dia.6mm	Used to drill holes on the wall
2		Screwdriver	wiring
3		Wire stripper	Strip wire
4		4mm Allen Key	Turn the screw to connect rear panel with inverter
5		Crimping tools	Used to crimp power cables
6		Multi-meter	Used to check grounding
7		Marker pen	Used to mark signs
8		Measuring tape	Used to measure distances
9		Level	Used to ensure that the rear panel is properly installed
10		ESD gloves	Operators wear

11		Safety goggles	Operators wear
12		Anti-dust respirator	Operators wear

### 3.5. Installation Position

HYD-ES inverter should be vertically mounted (to ensure fast heat dissipation), please choose a position without direct sunlight / snow accumulation to install HYD-ES inverter. Please the installation position is well-ventilated.

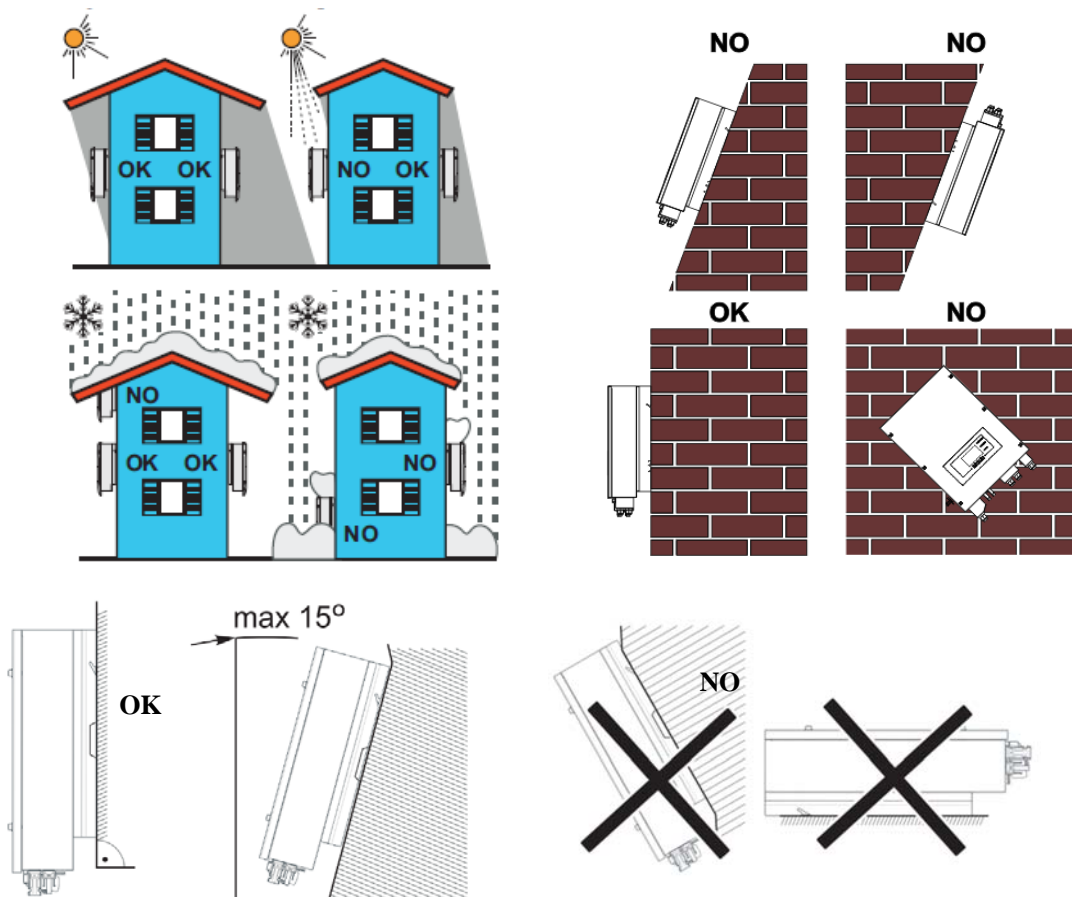

Fig. 4 Installation Position of HYD-ES inverter

### 3.6. Mount HYD-ES inverter

**Step 1:** Put the mounting bracket properly on the wall, mark these 8 drill holes using a marker pen. Drill 8 holes (drill bit 6mm) on the wall.

**Step 2:** Insert the expansion screw vertically into the hole, note the insertion depth. (not too shallow or too deep)

**Step 3:** Fix the mounting bracket on the wall using bolts & flat washers.

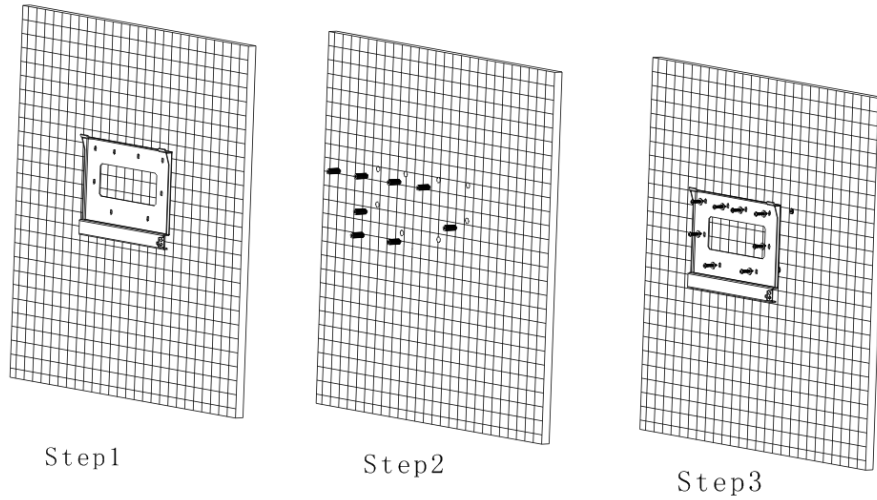



**Step 4:** Put HYD-ES inverter on the mounting bracket.

**Step 5:** Earth HYD-ES inverter using the grounding hole on the heat sink.

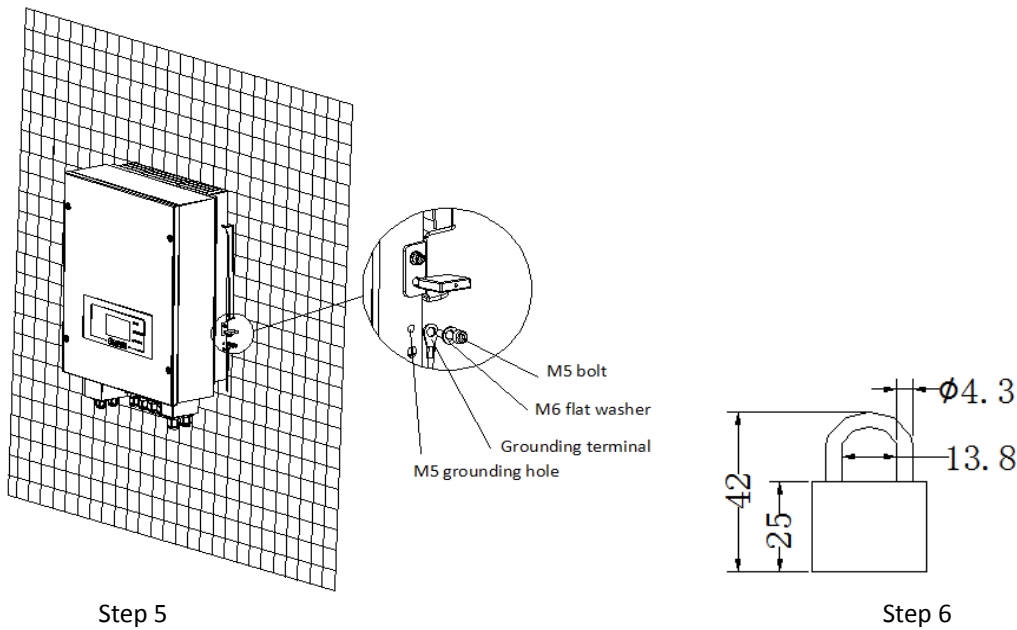
**Step 6:** OPTIONAL: you can lock HYD-ES inverter to the mounting bracket.



## 4. Electrical Connection

	<p><b>CAUTION</b></p>
	<p>High voltages in power conversion circuits. Lethal hazard of electric shock or serious burns.</p> <p>All work on the PV modules, inverters, and battery systems must be carried out by qualified personnel only.</p> <p>Wear rubber gloves and protective clothing (protective glasses and boots) when working on high voltage/high current systems such as INVERTER and battery systems.</p>
	<p><b>CAUTION</b></p>
	<p>HYD-ES inverter is intended to be used in PV system with battery storage. If not used as intended, the protection provided by the equipment may be impaired.</p>

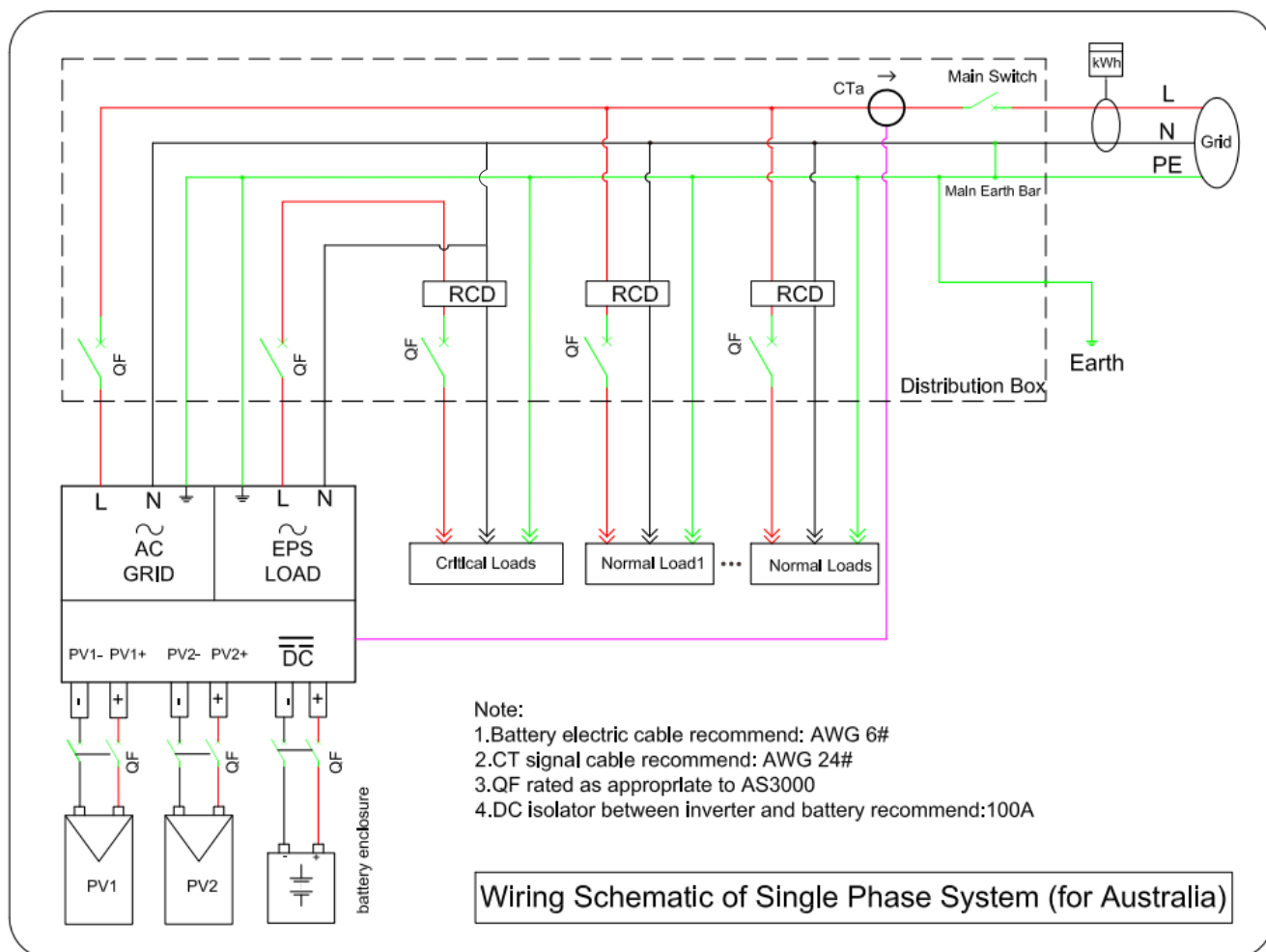

Fig. 5 Electrical connections

## 4.1. Battery Connection

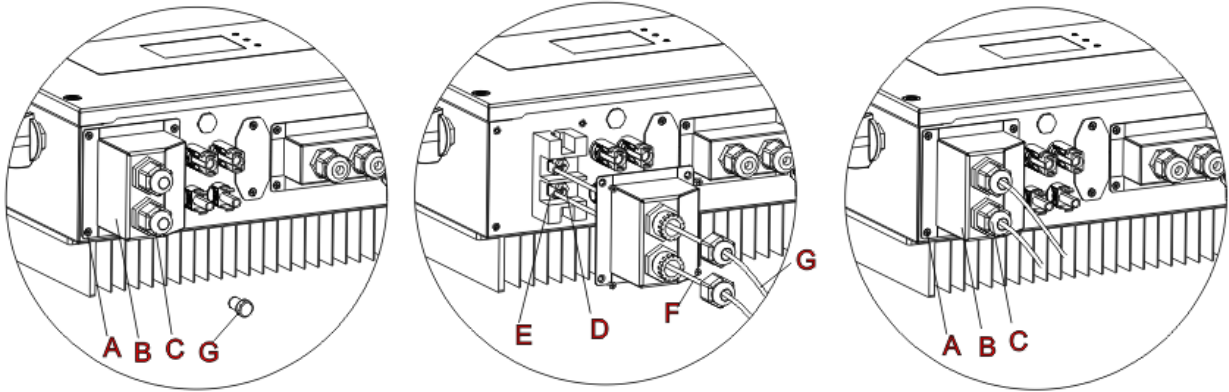

Fig. 6 Battery connection (Measure battery wires polarity/voltage before connection)

**Step 1:** Loosen 4 screws (A) using a screwdriver (Fig. 6);

**Step 2:** Remove the waterproof cover (B), loosen the cable gland (C), and then remove the stopper (G);

**Step 3:** Route the battery wires (F) through the cable gland, then connect battery wires using OT terminal (E);

**Step 4:** Fasten the waterproof cover using 4 screws.

## 4.2. PV Connection

Recommended DC input cable specifications

Cross-Sectional Area (mm <sup>2</sup> )		External Cable Diameter(mm <sup>2</sup> )
Range	Recommended Value	
4.0~6.0	4.0	4.5~7.8

**Procedure:**

**Step 1** Prepare PV positive and negative power cables

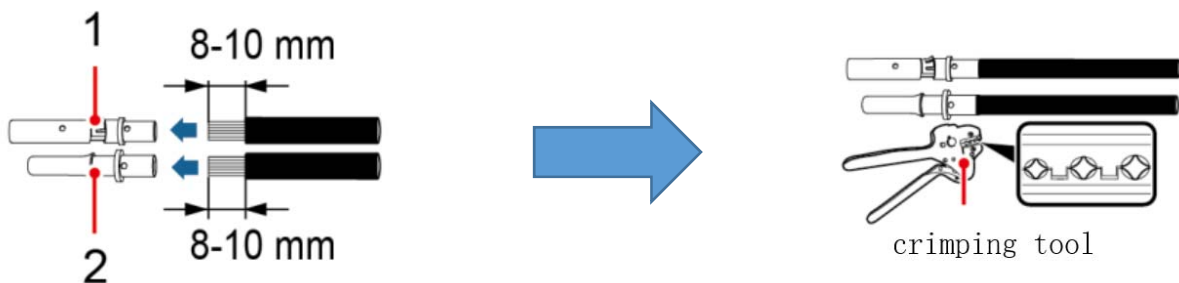

1. Positive metal contact 2. Negative metal contact

Fig. 7 prepare PV positive and negative power cables

**Step 2** Insert crimped PV positive and negative power cables into corresponding PV connectors

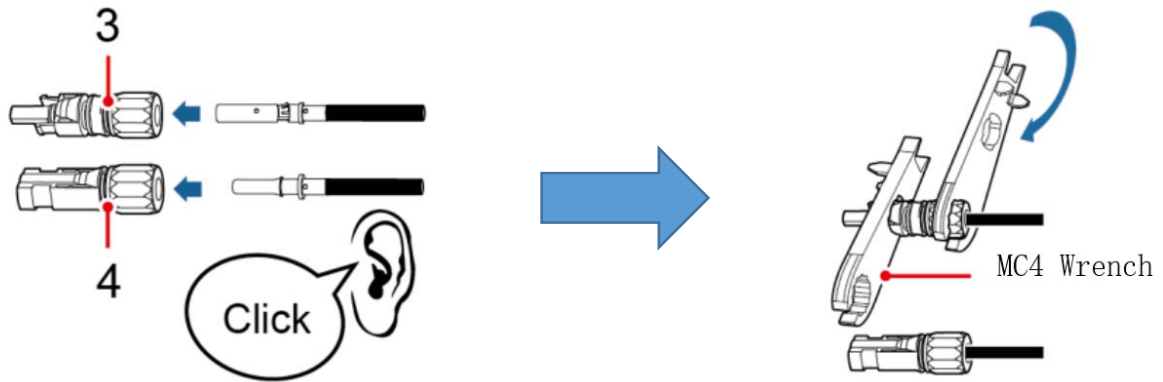

3. Positive connector 4. Negative connector

Fig. 8 prepare PV positive and negative connectors

**Step 3** Make sure the DC voltage of each PV string is less than 600V DC and polarities of PV power cables are correct. Insert the positive and negative connectors into HYD-ES inverter until you hear a "click" sound, as shown in Fig. 9.

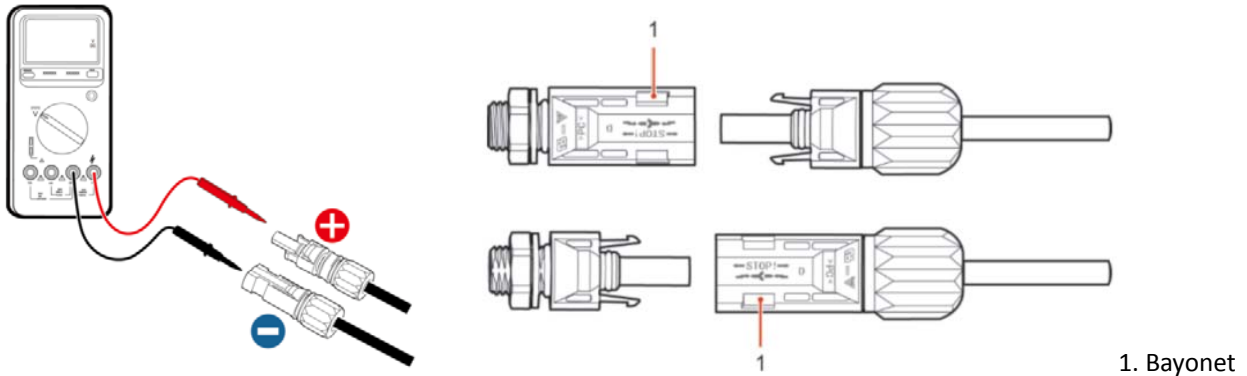

Fig. 9 Connect PV connectors

	<b>CAUTION</b>
	Before removing the PV positive and negative connectors, ensure that the DC SWITCH is OFF.

**Follow-up Procedure**

Use a MC4 wrench to disconnect PV connectors, as shown in Fig. 10.

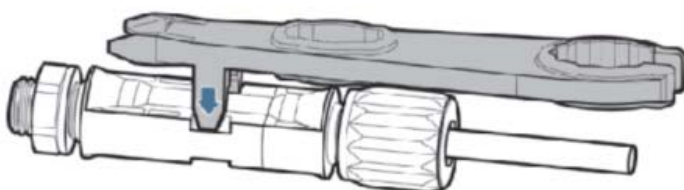

Fig. 10 Disconnect PV connectors

### 4.3. CT / CAN / RS485 / NTC connection

CT (Current transformer) can measure the value and direction of AC current. Refer to Fig. 11 for the correct connection of CTa.

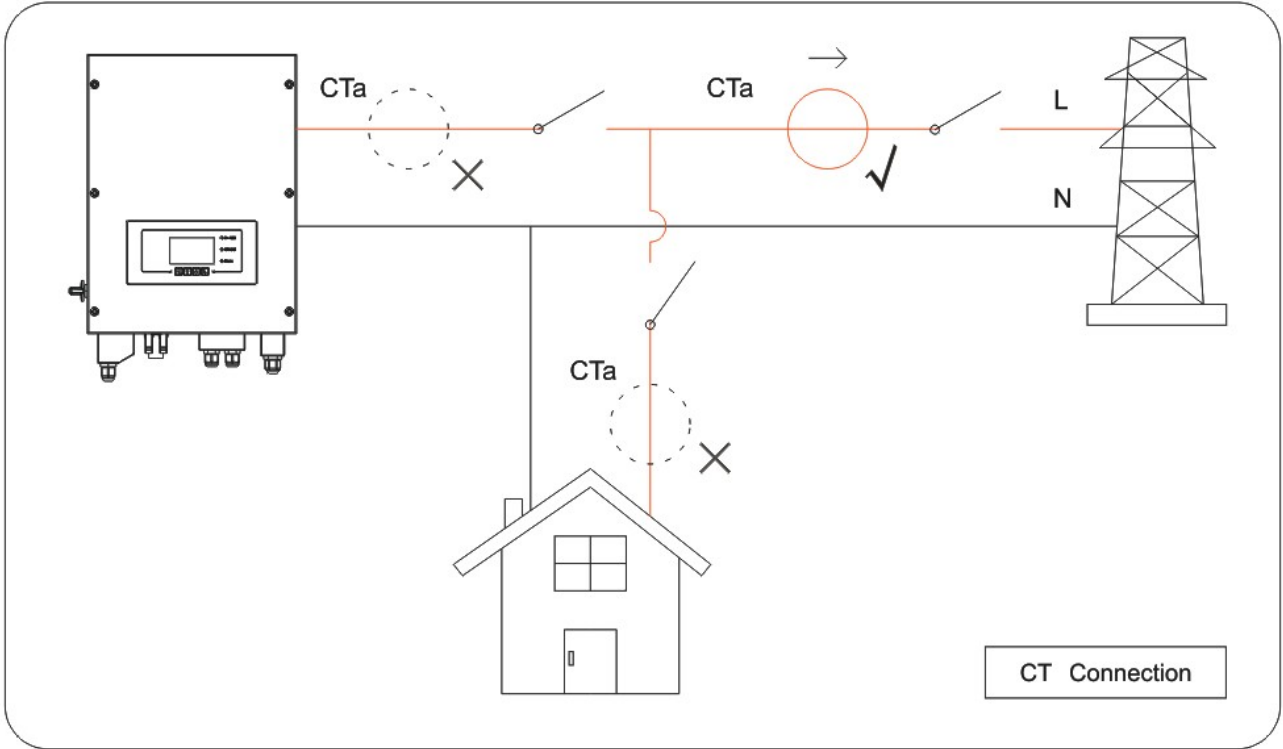

Fig. 11 CTa connection

**Step 1:** Refer to Fig. 11 for correct position of CTa. Wrap the CT around L wire of incoming mains, make sure that the CT arrow direction is “home → grid”.

**Step 2:** You can use network cable & terminal caps to extend CT wires if necessary, the maximum CT cable length is 200m.

CT wire	Extension cable (network cable)	HYD-ES inverter
Red	Orange / white orange / brown / white brown	CT+
Black	Green / white green / blue / white blue	CT-

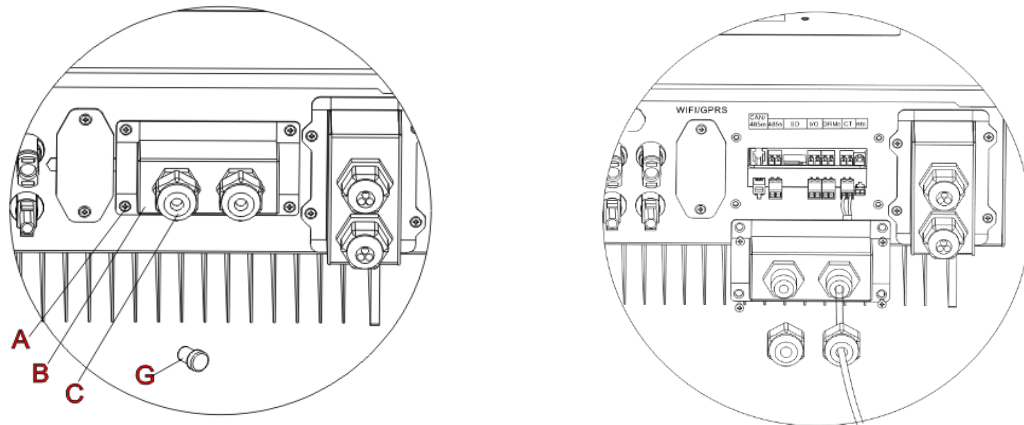

Fig. 12 CT / CAN / RS485 / NTC connection



**Step 3:** Loosen 4 screws (part A) using a screwdriver (Fig. 12)

**Step 4:** Remove the waterproof cover (part B), loosen the cable gland (part C), then remove the stopper (part G)

**Step 5:** Route CT cable through the cable gland, connect CT cable to CT terminal, then insert CT terminal into corresponding ports.

**Step 6:** One communication cable (between battery BMS & HYD-ES inverter) is provided in the HYD-ES inverter accessory bag. One inverter end, one BAT end.

Route the communication cable (inverter end) through the cable gland, insert the 4P4C connector to HYD3000/4000/5000/6000-ES CAN port. Insert the 8P8C connector (BAT end) to PYLONTECH battery CAN port.

Communication cable between battery & HYD-ES inverter	CAN communication	
	HYD-ES inverter	
	CAN port	CANH---pin1    CANL---pin2
	RS485 port	485A----pin3    485B----pin4
	PYLONTECH US2000 PLUS / US2000B	
	CAN Port	CANH---pin4    CANL---pin5
	RS485 port	485A----pin2 & pin7 485B----pin1 & pin8

**Step 7:** Connect NTC for lead acid batteries only: make the NTC to the battery surface with the tape, NTC can't close to the positive and negative of the battery, As shown in figure 13



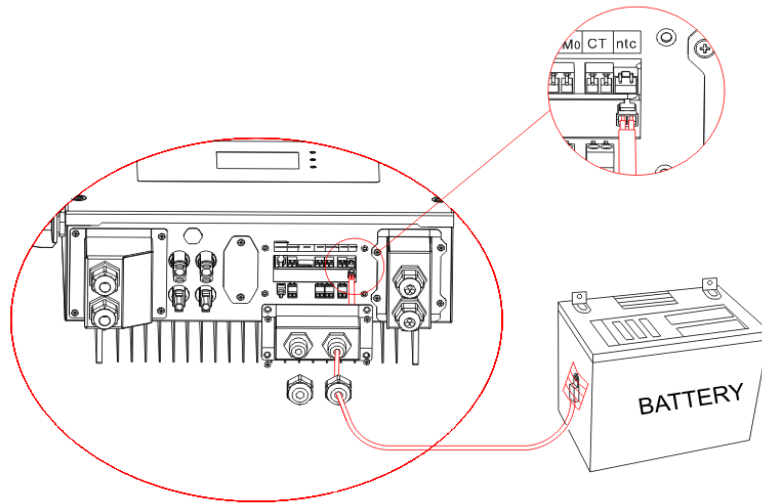

Fig. 13 NTC connection

**Step 8:** fasten the waterproof cover using 4 screws.

#### 4.4. Grid Connection

**Step 1:** Loosen 4 screws (part A) using a screwdriver (fig. 14)

**Step 2:** Remove the waterproof cover (part B), loosen the cable gland (part C), then remove the stopper (part G)

**Step 3:** Route a 3-core cable through GRID cable gland, then connect 3 wires to corresponding terminal blocks. (BROWN – L, BLUE – N, YELLOW/GREEN – PE)

**Step 4:** Fasten the waterproof cover using 4 screws.

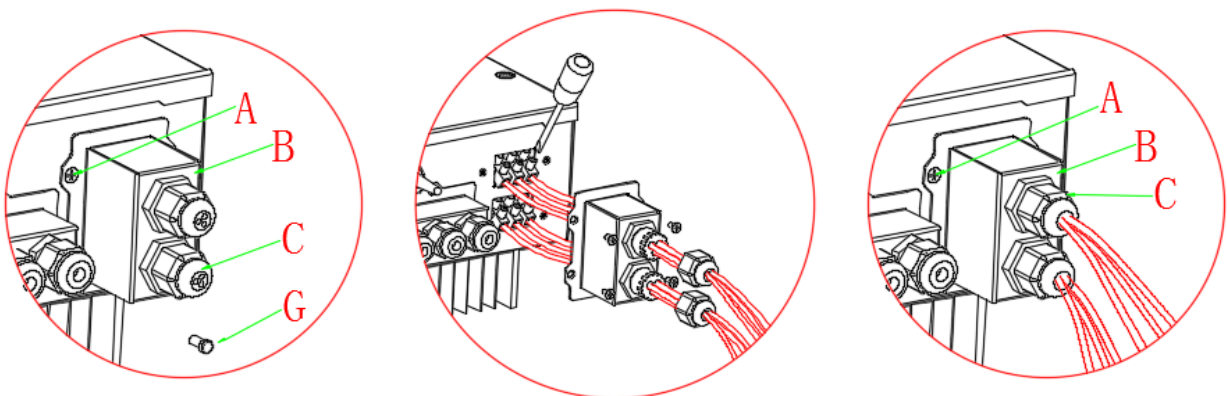

Fig. 14 Grid & Load connection

## 4.5. Critical Load Connection (EPS function)

Critical load: in case of grid outage, if EPS function is enabled, HYD-ES inverter will work in EPS (Emergency Power Supply) mode, utilize the PV power & energy stored in the battery to supply power to critical load via LOAD connection port.

LOAD connection port is only for critical load connection. The power of critical loads must be less than 3000VA.

The connection procedure of LOAD port is the same as grid connection (Fig. 14).

### Change-over positions

	<b>CAUTION</b>
	<p>The changeover switch is necessary.</p> <p>While checking/repairing critical load, make sure change-over switch is at position 0.</p> <p>While checking/repairing HYD-ES inverter, make sure change-over switch is at position 0 &amp; HYD-ES inverter is disconnected from grid.</p>

- ✧ Under normal conditions: change-over switch is at position 1. HYD-ES inverter can supply power to critical load in case of blackout.
- ✧ If the HYD-ES inverter is faulty, manually change the switch to position 2. Grid will supply power to critical load.

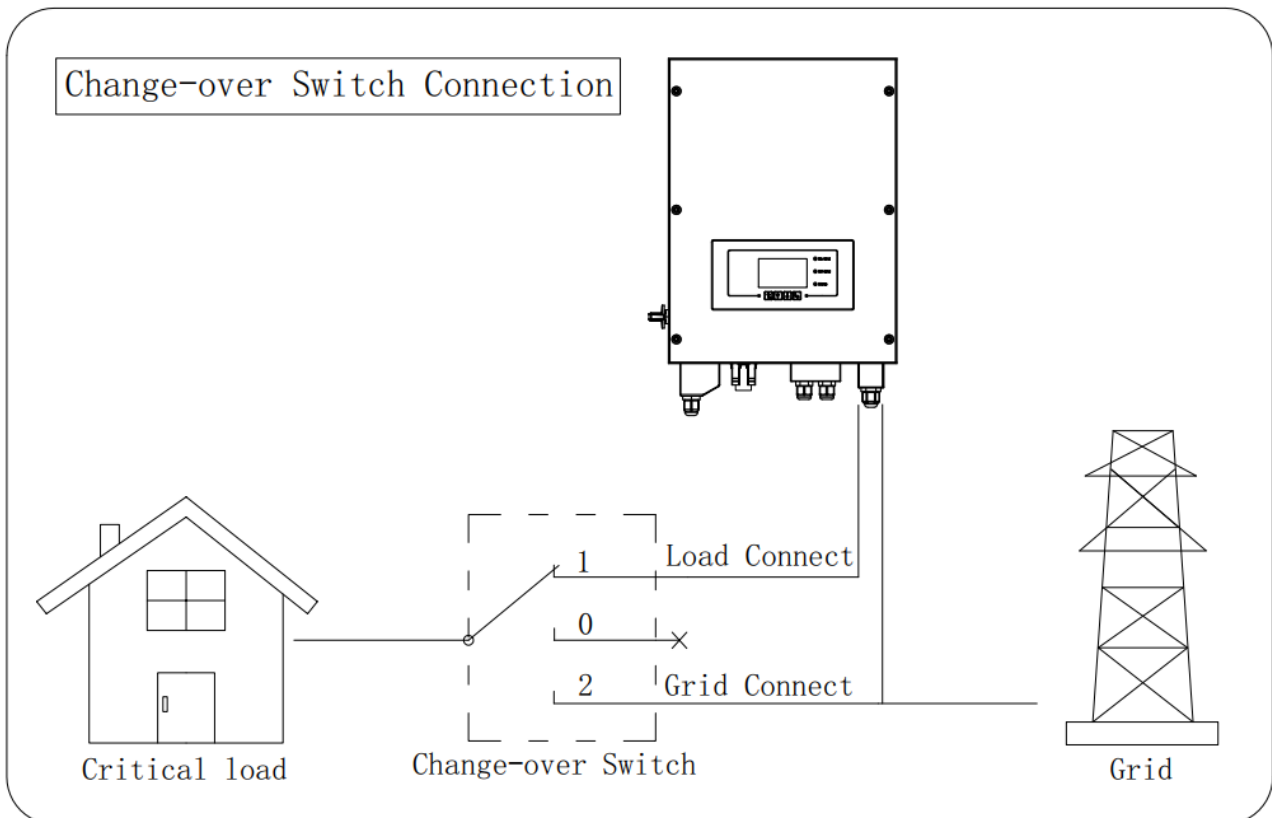

Fig. 15 Change-over Switch connections

## 5. Buttons and indicator lights

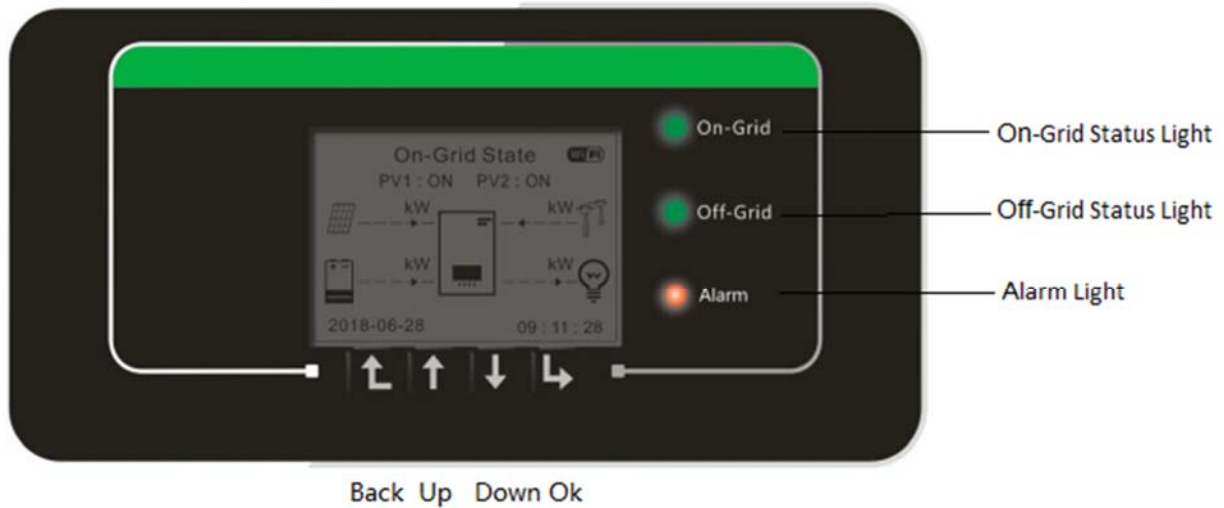

Fig 16. Buttons and indicator lights

### 5.1. Buttons:

- ✧ press “Back” to the previous screen or enter the main interface;
- ✧ press “Up” to the upper menu option or value plus 1;
- ✧ press “Down” to the lower menu option or value minus 1;
- ✧ Press “OK” to select the current menu option or switch to the next digit.

### 5.2. Indicator lights and status of HYD-ES inverter

Status of HYD inverter	On Grid Green light	Off-Grid Green light	Alarm Red light
On-grid	ON		
Standby (On-Grid)	Flashing		
Off-Grid		ON	
Standby (Off-Grid)		Flashing	
Alarm			ON

## 6. Operation

### 6.1. Double Check

Please double check the following before operation.

1. HYD-ES inverter is firmly fastened to the mounting bracket on the wall;
2. PV+/PV- wires are firmly connected, polarity and voltage are correct;
3. BAT+/BAT- wires are firmly connected, polarity and voltage are correct;
4. DC isolator is correctly connected between battery & HYD-ES inverter, DC isolator: OFF;
5. GRID / LOAD cables are firmly / correctly connected;
6. AC circuit breaker is correctly connected between HYD-ES inverter GRID port & GRID, circuit breaker: OFF;
7. AC circuit breaker is correctly connected between HYD-ES inverter LOAD port & critical load, circuit breaker: OFF;
8. For lithium battery, please ensure that the communication cable has been correctly connected;
9. For the lead-acid battery, please ensure that the NTC wire has been correctly connected.

### 6.2. First Time Setup (IMPORTANT!)

IMPORTANT: PLEASE FOLLOW THE FOLLOWING PROCEDURE to switch ON HYD-ES inverter

1. Make sure there's no power generation in HYD-ES inverter's phase.
2. Turn ON DC switch.
3. Switch ON the battery. Turn ON DC isolator between battery & HYD-ES inverter.
4. Turn ON AC circuit breaker between the HYD-ES inverter GRID port & GRID.
5. Turn ON AC circuit breaker between the HYD-ES inverter LOAD port & critical load.
6. HYD-ES inverter should start to operate now.

You need to set the following parameters before HYD-ES inverter starts to operate.

1)Set system time	8)*Set min discharge voltage
2)Set country	9)*Set max discharge current
3)Select battery type	10)*Set min protect voltage
4)*Set battery capacity	11)*Set discharge depth
5)*Set max charge voltage	12)*Set empty discharge voltage
6)*Set max charge current	13)*Set full charge voltage
7)*Set max protect voltage	

Note: 4)\* to 13)\* settings are only for DEFAULT battery type.

### 1)Set system time

System time format is “20YY-MM-DD-HH-MM-SS”, press “Up” or “Down” to change the 1<sup>st</sup> digit, press “OK” to switch to next digit, press “Ok” to complete setting. When system time setting is complete, “Set country” will pop up.

### 2)Set country

Press “Up” or “Down” to select a country, press “OK” to complete the country setting. When country setting is complete, “Set battery type” will pop up.

Code	Country	Code	Country	Code	Country
00	Germany VDE4105	11	France	22	Europe General
01	CEI-021 Internal	12	Poland	23	CEI-021 External
02	Australia	13	Germany BDEW	24	Cyprus
03	SpainRD1699	14	Germany VDE0126	25	India
04	Turkey	15	CEI-016 Italia	26	Philippines
05	Denmark	16	UK G83	27	New Zealand
06	Greece Continent	17	Greece island	28	Brazil
07	Netherland	18	EU EN50438	29	Slovakia VSD
08	Belgium	19	IEC EN61727	30	Slovakia SSE
09	UK G59	20	Korea	31	Slovakia ZSD
10	China	21	Sweden	32	CEI0-21 In Areti

	<b>CAUTION</b>
	<p>It's very important to make sure that you have selected the correct country code according to requirements of local authority.</p> <p>Please consult qualified electrical engineer or personnel from electrical safety authorities about this.</p> <p>Shenzhen SOFARSOLAR Co., Ltd. is not responsible for any consequences arising out of incorrect country code selection.</p>

### 3)Select battery type

Press “Up” or “Down” to select your battery type, then press “OK” to complete the battery type setting.

If you're using “1. PYLON”, “2. DARFON”, “4. General Lithium”, “5. Alpha. ESS” or “6. SOLTARO” battery types, congratulations, inverter's first-time setup is complete. Please press “OK” to enter the main interface.

But if you're using “3. DEFAULT” battery type. We need more information regarding your battery.

MENU	Compatible Batteries
1.PYLON	PYLONTECH US2000 PLUS / US2000B

	Note: Please confirm with representative of PYLONTECH that your battery is compatible with HYD3000/4000/5000/6000-ES
2. DARFON	DARFON 14S31P ESS
3. DEFAULT	LEAD ACID / LEAD CRYSTAL / AQUION battery
4. General Lithium	All batteries that comply with SOFAR'S BMS CAN communication protocol.
5. Alpha. ESS	M48112-P / SMILE-BAT
6. SOLTARO	SL-3KWH / SL-1KWH

**4)\*Set battery capacity (only for DEFAULT battery type)**

Press "Up" or "Down" to change the 1<sup>st</sup> digit, press "OK" to switch to next digit. After changing the battery capacity per your battery specification, press "Ok", then "Set max charge voltage" will pop up.

**5)\*Set max charge voltage (only for DEFAULT battery type)**

Press "Up" or "Down" to change the 1<sup>st</sup> digit, press "OK" to switch to next digit. After changing max charge voltage per your battery specification, press "Ok", then "Set max charge current" will pop up.

**6)\*Set max charge current (only for DEFAULT battery type)**

Press "Up" or "Down" to change the 1<sup>st</sup> digit, press "OK" to switch to next digit. After changing the max charge current per your battery specification, press "Ok", then "Set max protect voltage" will pop up.

**7)\*Set max protect voltage (only for DEFAULT battery type)**

Press "Up" or "Down" to change the 1<sup>st</sup> digit, press "OK" to switch to next digit. After changing the max protect voltage per your battery specification, press "Ok", then "Set min discharge voltage" will pop up.

**8)\*Set min discharge voltage (only for DEFAULT battery type)**

Press "Up" or "Down" to change the 1<sup>st</sup> digit, press "OK" to switch to next digit. After changing the min discharge voltage per your battery specification, press "Ok", then "Set max discharge current" will pop up.

**9)\*Set max discharge current (only for DEFAULT battery type)**

Press "Up" or "Down" to change the 1<sup>st</sup> digit, press "OK" to switch to next digit. After changing the max discharge current per your battery specification, press "Ok", then "Set min protect voltage" will pop up.

**10)\*Set min protect voltage (only for DEFAULT battery type)**

Press "Up" or "Down" to change the 1<sup>st</sup> digit, press "OK" to switch to next digit. After changing the min protect voltage per your battery specification, press "Ok", then "Set discharge depth" will pop up.

**11)\*Set discharge depth (only for DEFAULT battery type)**

Press "Up" or "Down" to change the 1<sup>st</sup> digit, press "OK" to switch to next digit. After changing the discharge depth per your battery specification, press "Ok", then "Set empty discharge voltage" will pop up.

**12)\*Set empty discharge voltage (only for DEFAULT battery type)**

Press “Up” or “Down” to change the 1<sup>st</sup> digit, press “OK” to switch to next digit. After changing the empty discharge voltage per your battery specification, press “Ok”, then “Set full charge voltage” will pop up.

13)\*Set full charge voltage (only for DEFAULT battery type)

Press “Up” or “Down” to change the 1<sup>st</sup> digit, press “OK” to switch to next digit. After changing the full charge voltage per your battery specification, press “Ok”.

Congratulations, HYD3000/4000/5000/6000-ES’s first-time setup is complete. Please press “OK” to enter the main interface.

### 6.3. Commissioning

The main interface:

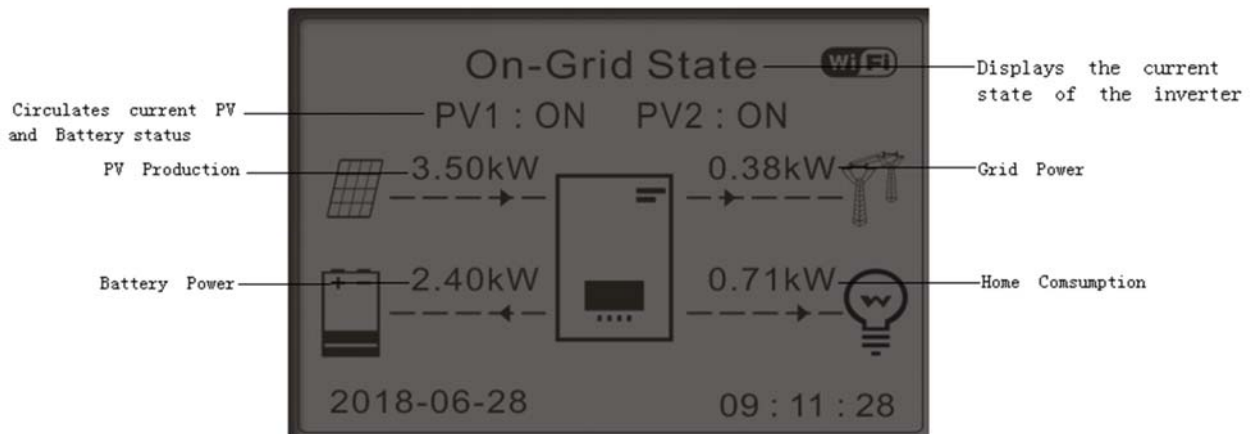

Fig 17. Main interface

If you didn’t change the work mode of HYD-ES inverter, which means HYD-ES inverter is working in “Auto Mode”:

While “PV Production” > “Home Consumption”

If the battery is not full. HYD-ES inverter will charge the battery.

While “PV Production” < “Home Consumption”

If the battery is not flat. HYD-ES inverter will discharge the battery.

### 6.4. Menu

In the main interface, press “Down” button to enter grid/battery parameters page:

Main Interface	Press “Down”
	1.Grid(V)
	2.AC Current(A)
	3.Frequency

	4.Batt(V)
	5.Batt Chrg Curr.
	6.Batt DisChrg Curr.
	7.State of Charge
	8.Batt Cycles
	9.Batt Temp.

In the main interface, press “UP” button to enter PV parameters page:

Main Interface	Press “UP”
	1.PV1 Voltage
	2.PV1 Current
	3.PV1 Power
	4.PV2 Voltage
	5.PV2 Current
	6.PV2 Power
	7.Inverter Temp.

In the main interface, press “back” button to enter main menu. The main menu has the following five options:

Main Interface	Press “Back”
	1.Basic Setting
“Up” ↑	2.Advanced Setting
	3.Event List
“Down” ↓	4.System Information
	5.Energy Statistic
	6.Software Update

### 6.4.1. Basic setting

1.Basic Setting	Press “OK”
	1.Language
	2.Time
Up” ↑	3.Energy Storage Mode
	4.PV Input Mode



"Down" ↓	5.EPS Mode
	6.Communication Addr.
	7.Auto Test

### 1. Set Language

Select "1. Language", press "OK". Press "up" or "down" to select the language and press "OK".

Easier Way: press "Back" & "OK" at the same time to change system language.

### 2. Set Time

Select "2. Time", press "OK" to enter time setting interface, system time format is 20YY-MM-DD HH:MM:SS

Press "Up" or "Down" to change the 1<sup>st</sup> digit, press "OK" to switch to next digit, after inputting the current time, press "OK".

### 3. Energy Storage Mode

Select "3. Energy Storage Mode", press "OK" to enter energy storage mode setting interface.

3.Energy Storage mode	
"Up" ↑	1. Self-use Mode
	2. Time-of-use Mode
	3.Timing Mode
"Down" ↓	4. Passive Mode

#### 1) Set Auto Mode

Select "1. Set Auto Mode", then press "OK".

In auto mode, HYD-ES inverter will automatically charge & discharge the battery.

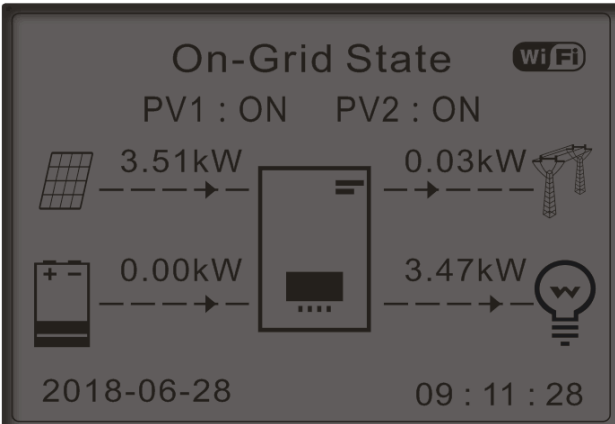
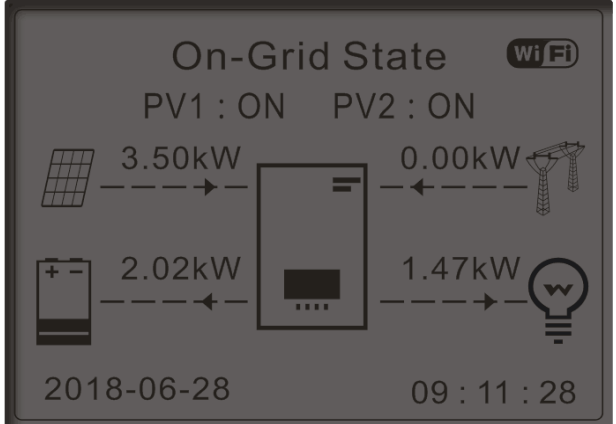
<p>1) If PV generation = LOAD consumption (<math>\Delta P &lt; 100W</math>) HYD-ES won't charge or discharge the battery.</p> 	<p>2) If PV generation &gt; LOAD consumption, the surplus power will be stored in the battery.</p> 
---	---

3) If the battery is full(or already at Max Charge Power), excess power will be exported to the grid.

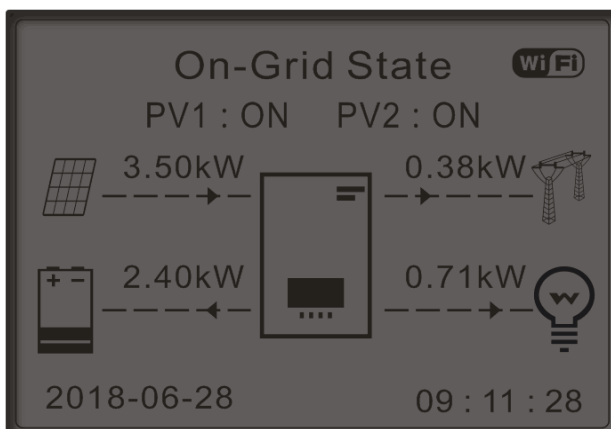

4) If PV generation < LOAD consumption, it will discharge the battery to supply power to load.

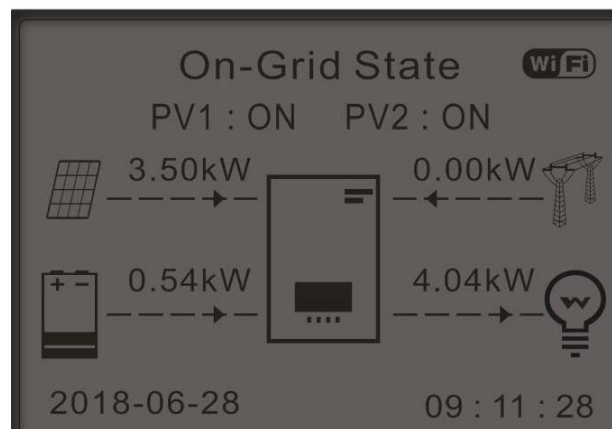

5) If PV generation + Battery < LOAD consumption, HYD-ES inverter will import power from the grid.

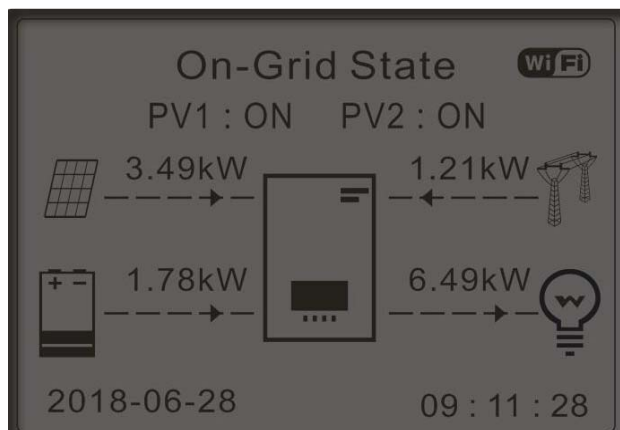

6) Press "DOWN" button to view current grid/battery parameters, press "UP" to get back to main interface.

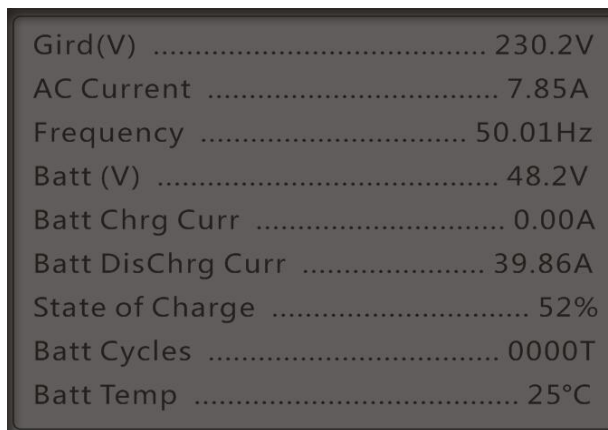

## 2) Set Time-of-use Mode

Select "2. Set Time-of-use Mode", and then press "OK" to enter Set Time-of-use mode interface.

Set Time-of-use Mode			
Rules. 0: Enabled			
From	To	SOC	Charge
02h00m	- 04h00m	070%	1000W
Effective date			
Dec. 22 - Mar. 21			
Weekday select			
Mon. Tue. Wed. Thu. Fri. Sat. Sun.			

If electricity is more expensive in high demand time (peak rate) & electricity is much cheaper in low demand time (off-peak rate).

You can select an off-peak period to charge your battery. Outside the off-peak charge period, HYD-ES inverter is working in Auto Mode.

If your family normally go to work/school on weekdays & stay at home on weekends, which means the home electricity consumption is much higher on weekends. Thus, you need to store some cheap electricity on weekends only. This is possible using our Time-of-use mode.

In summer, if your PV system can produce more electricity than your home electricity consumption. Then you don't need to set an off-peak charge period to charge your battery in summer at all. You can select an effective date (normally winter) for Time-of-use mode in this case. Outside the effective date, HYD-ES inverter is working in Auto Mode.

You can set multiple Time-of-use rules to meet your more complex requirement. Right now we support 4 rules maximum (rule 0/1/2/3).

### 3) Set Timing Mode

Select "3. Set Timing Mode", and then press "OK" to enter Set Timing mode interface. The interface of Set Timing Mode is shown as below. You can select a charge time/power & discharge time/power in this mode.

Charge Start	22 h 00 m
Charge End	05 h 00 m
Charge Power	2000 W
DisCharge Start	14 h 00m
DisCharge End	16 h 00m
DisCharge Power	2500 W

Note: normally this mode is used to test whether HYD-ES inverter can charge & discharge correctly or not. So basically, this mode is used for testing purposes only.

### 4) Set Passive Mode

Select "4. Set Passive Mode", and then press "OK".

For more detailed information, please ask representative of SOFAR to get a copy of passive mode communication protocol.

## 4. PV Input Mode

PV input mode selection: HYD-ES inverter has 2 MPPT channels. The 2 MPPT can operate independently, also can operate in parallel. If the PV strings are connected in parallel outside the inverter, you should choose the "in parallel mode", otherwise use the default setting (independent mode).

## 5. EPS Mode

5. Set EPS Mode	1.EPS Mode Control	1.Enable EPS Mode
		2.Disable EPS Mode
	2.Set EPS Changeover Time ( default 20ms )	***S()

1) If PV generation > LOAD consumption ( $\Delta P > 100W$ ), HYD-ES inverter will charge battery.

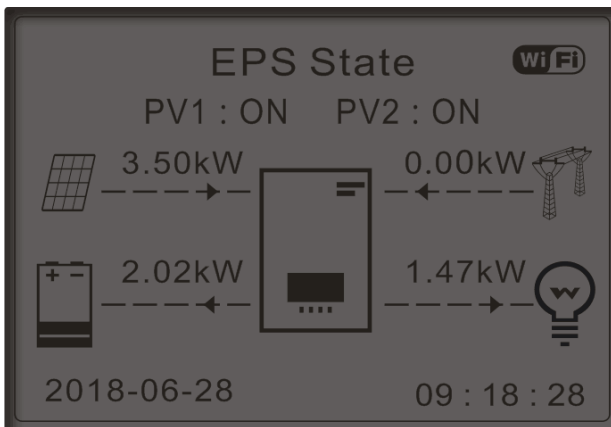

2) If PV generation = LOAD consumption, HYD-ES inverter won't charge or discharge battery.

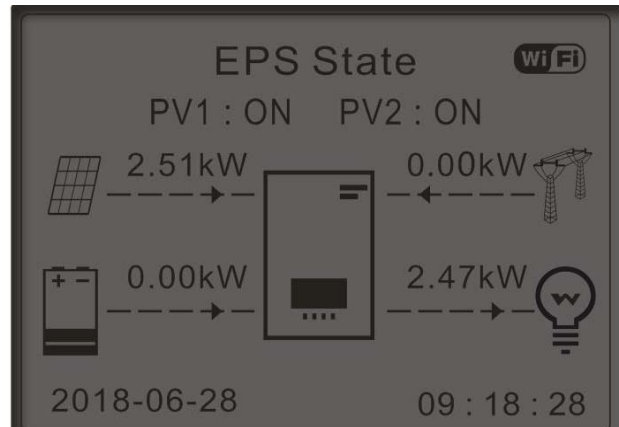

3) If PV generation < LOAD consumption ( $\Delta P > 100W$ ), HYD-ES inverter will discharge battery.

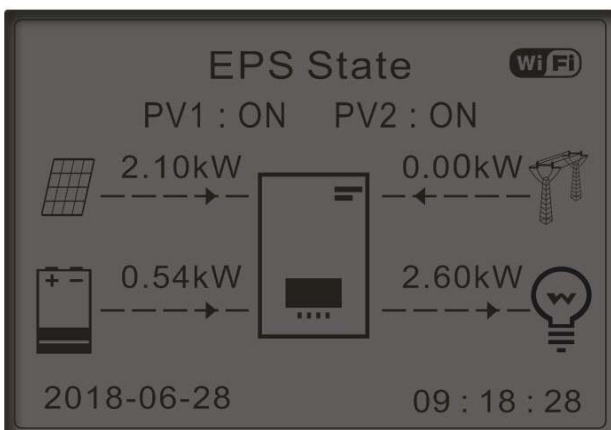

4) If PV generation is normal, but LOAD consumption=0, the surplus power will be stored in the battery.

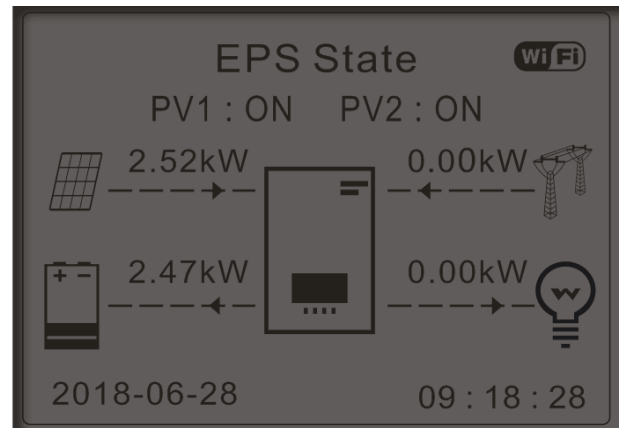

## 6. Communication Addr.

Select "6. Set Communication Addr.", press "OK". Press "Up" or "Down" to change the 1<sup>st</sup> digit, press "OK" to switch to next digit, after changing the 485-communication address (**default :01**), press "OK".

## 7. Auto Test (ONLY for Italian Market)

Select "7. Auto Test", press "OK" to enter autotest interface.

7.Auto Test	
	1.Autotest Fast
"Up" ↑	2.Autotest STD
	3.QF Time Setting
"Down" ↓	4.QV Time Setting
	5.Control 81.S1

1) Autotest Fast

Select "1. Autotest Fast", then press "OK" to start Auto test Fast.

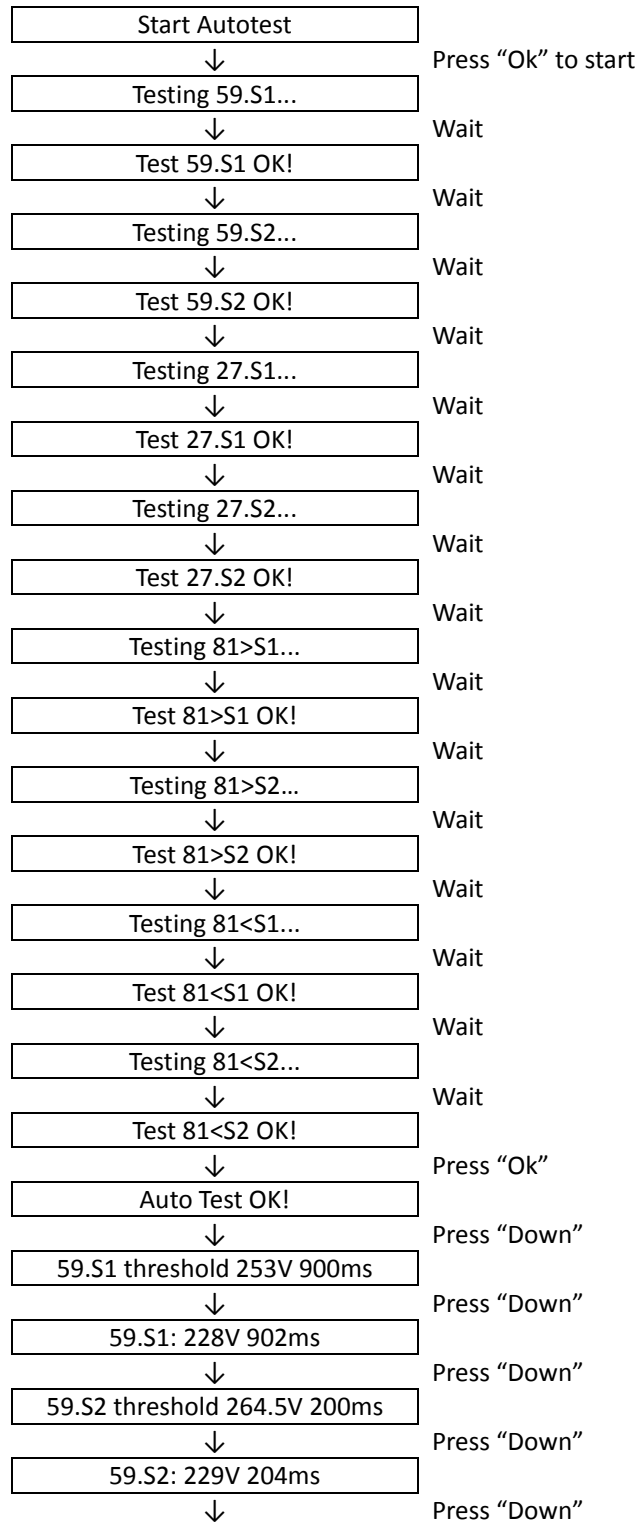



2) Autotest STD

Select "2. Autotest STD", then press "OK" to start Auto test STD.

The test procedure is same as Autotest Fast, but it's much more time consuming.

3) PF Time Setting

Select "3. PF Time Setting", then press "OK". The following will be shown on the display:

Set: \*. \*\*\* s

Press "Up" or "Down" to change the 1<sup>st</sup> digit, press "OK" to switch to next digit. After changing all digits, press "OK".

4) QV Time Setting

Select "4. QV Time Setting", then press "OK". The following will be shown on the display:

Set : \*\* s

Press "Up" or "Down" to change the 1<sup>st</sup> digit, press "OK" to switch to next digit. After changing all digits, press "OK".

5) Control 81.S1

Select "5. Control 81.S1", press "OK". Press "up" or "down" to select "Enable 81.S1" or "Disable 81.S1", press "OK".

## 6.4.2. Advanced setting

2.Advanced Setting	Input Password 0001	
Up" ↑	1.Battery Parameter	
	2.Clear Energy Data	
	3.Clear Events	
	4.Country	
"Down" ↓	5.Anti Reflux	
	6.IV Curve Scan	
	7.Battery Active	
	8.DRMs0 Control	
	9.Safety Param.	

Select "2. Advanced Setting" and press "OK", "input password" is shown. Input the password "0001", press "Up" or "Down" to change the 1<sup>st</sup> digit, press "OK" to switch to next digit, when "0001" is shown on the screen, press "OK" to enter "2. Advanced Setting" interface.

If "Incorrect, Try Again!" is shown on the screen, press "Back" and input the password again.

### 1. Battery Parameter

1.Battery Parameter		
"Up" ↑	1)Battery Type	7)Max Discharge (A)
	2)*Battery Capacity	8)*Low (V) Protection
"Down" ↓	3)Discharge Depth	9)*Min Discharge (V)
	4)Max Charge (A)	10)*Empty Discharged (V)
	5)*Over (V) Protection	11)*Full Charged (V)
	6)*Max Charge (V)	12)Save

Note: 2)\*, 5)\*, 6)\*, 8)\*, 9)\*, 10)\* and 11)\* settings are only for DEFAULT battery type.

#### 1) Battery Type (refer to Set [battery type](#))

Select "1. Battery Type" and press "OK". Press "up" or "down" to select the battery type. Press "OK".

#### 2) \*Battery Capacity (only for DEFAULT battery type)

Select "2. Battery Capacity" and press "OK". Press "up" or "down" to change the 1<sup>st</sup> digit, press "ok" to switch to next digit. Input the value of battery capacity. Press "OK".

#### 3) Discharge Depth

Select "3. Discharge Depth" and press "OK" to enter discharge depth interface.

Discharge Depth	50%
EPS Discharge Depth	80%
EPS Restore Depth	20%

Press "up" or "down" to change the 1<sup>st</sup> digit, press "ok" to switch to next digit. Input the value of Discharge Depth &

EPS Discharge Depth per battery specification. Press "OK".

For example: if Discharge Depth = 50% & EPS Discharge Depth = 80%.

While grid is connected: HYD-ES inverter won't discharge the battery when its SOC is less than 50%.

In case of blackout: HYD-ES inverter will work in EPS mode (if EPS mode is enabled) & keep discharging the battery till battery SOC is less than 20%.

#### 4) Max. Charge (A)

Select "4. Max. Charge (A)" and press "OK". Press "up" or "down" to change the 1<sup>st</sup> digit, press "ok" to switch to next digit. Input the value of Max. Charge (A) per battery specification. Press "OK".

#### 5) \*Over (V) Protection (only for DEFAULT battery type)

Select "5. Over (V) Protection" and press "OK". Press "up" or "down" to change the 1<sup>st</sup> digit, press "ok" to switch to next digit. Input the value of Over (V) Protection per battery specification. Press "OK".

#### 6) \*Max. Charge (V) (only for DEFAULT battery type)

Select "6. Max. Charge (V)" and press "OK". Press "up" or "down" to change the 1<sup>st</sup> digit, press "ok" to switch to next digit. Input the value of Max. Charge (V) per battery specification. Press "OK".

#### 7) Max. Discharge (A)

Select "7. Max. Discharge (A)" and press "OK". Press "up" or "down" to change the 1<sup>st</sup> digit, press "ok" to switch to next digit. Input the value of Max. Discharge (A) per battery specification. Press "OK".

#### 8) \*Low (V) Protection (only for DEFAULT battery type)

Select "8. Low (V) Protection" and press "OK". Press "up" or "down" to change the 1<sup>st</sup> digit, press "ok" to switch to next digit. Input the value of Low (V) Protection per battery specification. Press "OK".

#### 9) \*Min. Discharge (V) (only for DEFAULT battery type)

Select "9. Min. Discharge (V)" and press "OK". Press "up" or "down" to change the 1<sup>st</sup> digit, press "ok" to switch to next digit. Input the value of Min. Discharge (V) per battery specification. Press "OK".

#### 10) \* Empty Discharged (V) (only for DEFAULT battery type)

Select "10. Empty Discharged (V)" and press "OK". Press "up" or "down" to change the 1<sup>st</sup> digit, press "ok" to switch to next digit. Input the value of Empty Discharged Voltage per battery specification. Press "OK".

#### 11) \* Full Charged (V) (only for DEFAULT battery type)

Select "11. Full Charged (V)" and press "OK". Press "up" or "down" to change the 1<sup>st</sup> digit, press "ok" to switch to next digit. Input the value of Full Charged Voltage per battery specification. Press "OK".

#### 12) Save

Select "12. Save" and press "OK" to complete setting battery parameters.

### 2. Clear Energy Data

Select "2. Clear Energy" and press "OK", "input password" is shown. Input the password "0001", press "Up" or "Down" to change the 1<sup>st</sup> digit, press "OK" to switch to next digit, when "0001" is shown on the screen, press "OK". If "Incorrect, Try Again!" is shown on the screen, press "Back" and input the password again.

### 3. Clear Events

Select "3. Clear Events", press "OK" button twice to clear all the events.

### 4. Country (refer to [Set country](#))



Select "4. Country", press "OK", current country setting is shown, input new country code & press "OK"

### 5. Anti Reflux

5.Anti Reflux Control	1.Anti Reflux Control	Enable
"Up" ↑		Disable
"Down" ↓	2.Reflux Power	***KW

The user can enable "Anti Reflux Control" to limit the max export power to grid.

Select "2. Reflux Power" to input desired max export power to grid.

### 6. IV Curve Scan

6.IV Curve Scan	1.Scan Control	Enable
"Up" ↑		Disable
"Down" ↓	2.Scan Period	***min
	3.Force Scan	

The user can enable "IV Curve Scan" (MPPT scan) to make HYD-ES inverter to find the global max power point periodically to deliver max power from a partially shaded PV array.

The user can input scan period or make HYD-ES inverter to perform a scan right away.

### 7. Battery Active

7.Battery Active	1.Auto Active Control	Enable
"Up" ↑		Disable
"Down" ↓	2.Force Active	

HYD-ES inverter can activate flat batteries when needed.

The user can enable "Auto Active Control" to allow HYD-ES inverter to activate flat batteries automatically. Or make HYD-ES inverter to activate the battery right away.

### 8. DRMs0 control

Select "8. DRMs0 Control", press "OK", press "up" or "down" to select "Enable DRMs0" or "Disable DRMs0", press "OK".

### 9. Safety Param.

9.Safety Param.	1.Set START Parameters
	2.Set Safety Voltage
	3.Set Safety Frequency
	4.Set Insulation

Copy the TXT file to the root directory of SD card.

Select "9. Safety Param.", press "OK", press "up" or "down" to select "1. Set START Parameters", "2. Set Safety Voltage", "3. Set Safety Frequency" or "4.Set Insulation", then press "OK".

Please contact SOFAR technical support for more information.

### 6.4.3. Event List

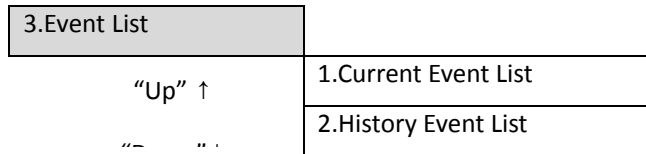

Event list of HYD-ES inverter, including current event list and history event list.

#### 1) Current Event List

Select "1. Current Event List", press "OK" to check the current events.

#### 2) History Event List

Select "2. History Event List", press "OK" to check the historical events. Press "up" or "down" to check all historical events if there're more than 1 page of events.

### 6.4.4. System information interface

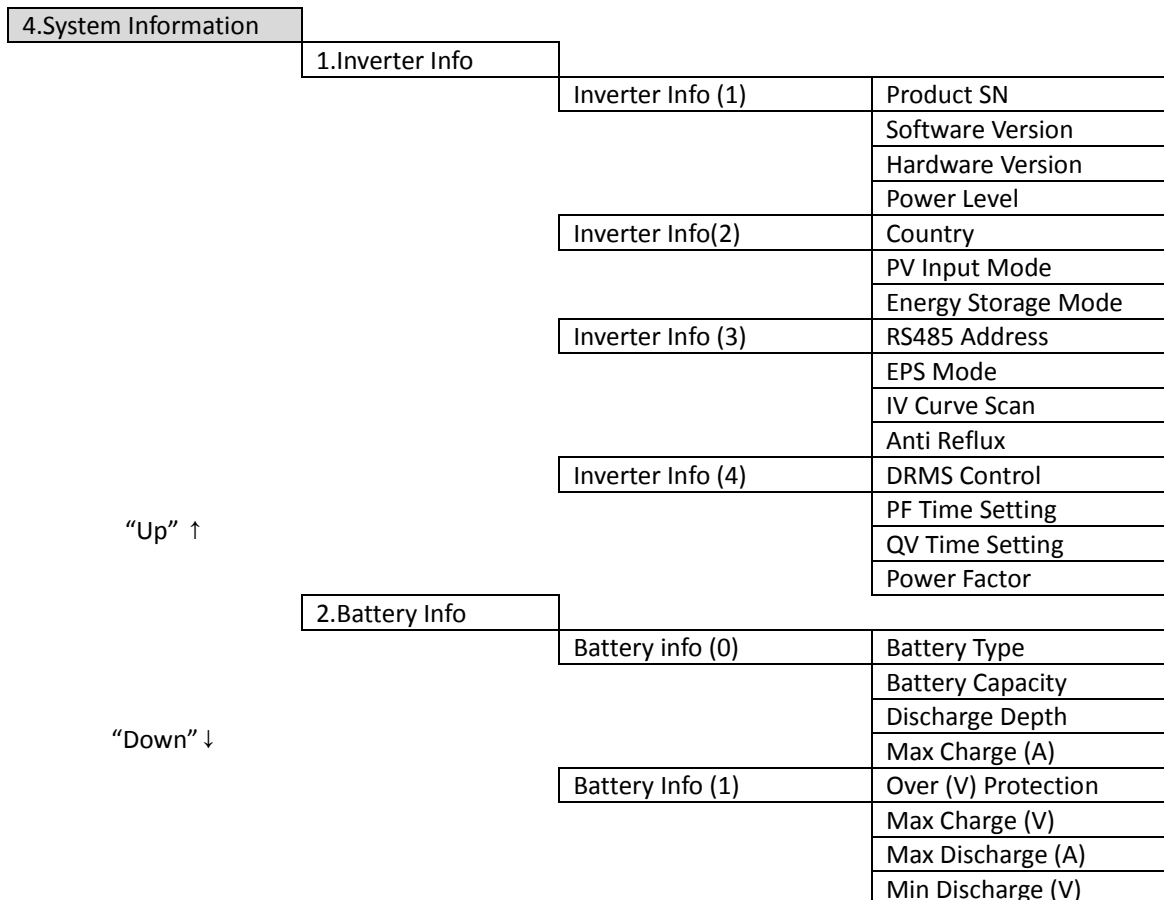

3.Safety Param.	Safety Param.(0)	OVP 1
		OVP 2
		UVP 1
		UVP 2
	Safety Param.(1)	OFP 1
		OFP 2
		UFP 1
		UFP 2
	Safety Param.(2)	OVP 10mins

### 6.4.5. Energy Statistic

5.Energy Statistic	Today	
	PV	***KWH
	Load	***KWH
	Export	***KWH
	Import	***KWH
	Charge	***KWH
	Discharge	***KWH
	“Up” ↑	
	Week	
	PV	***KWH
	Load	***KWH
	Export	***KWH
	Import	***KWH
	Charge	***KWH
	Discharge	***KWH
	“Down” ↓	
	“Up” ↑	
	Month	
	PV	***KWH
	Load	***KWH
	Export	***KWH
	Import	***KWH
	Charge	***KWH
	Discharge	***KWH
	“Down” ↓	
	“Up” ↑	
	Year	
PV	***KWH	
Load	***KWH	
Export	***KWH	
Import	***KWH	
Charge	***KWH	
Discharge	***KWH	
“Down” ↓		
Lifetime		
PV	***KWH	
Load	***KWH	
Export	***KWH	
Import	***KWH	
Charge	***KWH	

Discharge	***KWH
Charge	***KWH
Discharge	***KWH

Select "5. Energy Statistic", press "OK" to enter Energy Statistic interface, it shows the energy generation and consumption within a certain range of time. Press "Up" or "Down" to check the daily / weekly / monthly / yearly / lifetime energy statistics.

## 6.4.6. Software upgrade

Copy the firmware folder to the root directory of SD card.

Select "6. Software Update", press "OK", "input password" is shown. Input the password ("0715"), press "Up" or "Down" to change the 1<sup>st</sup> digit, press "OK" to switch to next digit, when "0715" is shown on the screen, press "OK". HYD-ES inverter will start to upgrade the software automatically.

### Detailed Firmware Upgrade Procedure:

**Step 1** Turn OFF AC circuit breaker (grid & load), then turn OFF DC isolator (battery) and PV switch, then remove communication waterproof cover. If communication cables (CAN/RS485/NTC/CT) have been connected, loosen their cable glands before removing cover.

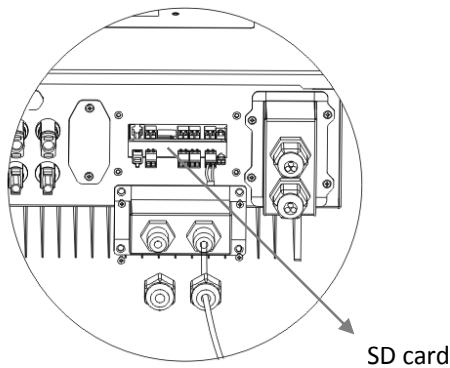

**Step 2** Press the SD card and take it out. Insert the SD card into a micro-SD card reader, then insert micro-SD card reader into a PC; (NOTE: micro-SD card reader & PC are not provided by SOFARSOLAR).

**Step 3** Format the SD card. Copy the "firmware" folder to the SD card.

**Step 4** Insert the SD card back to the SD card slot.

**Step 5** Turn ON AC circuit breaker (grid), press "Back" to enter main menu. Press "Down" to select "6. Software Update", then press "OK".

**Step 6** "input password" is shown. Input the password ("0715"), press "Up" or "Down" to change the 1<sup>st</sup> digit, press "OK" to switch to next digit, when "0715" is shown on the screen, press "Ok" to start firmware update.

**Step 7** After finishing firmware upgrade, turn OFF AC circuit breaker (grid), lock the communication waterproof cover with four screws, then turn ON AC circuit breaker (grid), turn ON DC isolator (battery), turn on PV switch, HYD-ES inverter will start to operate automatically.

NOTE: If "DSP communicate fail", "Update DSP1 Fail" or "Update DSP2 Fail" is shown on the screen, which means the firmware upgrade is unsuccessful, please turn OFF AC circuit breaker (grid), wait 5 minutes, then start again from "Step 5"

## 7. Technical Data

Model	HYD 3000-ES	HYD 3600-ES	HYD 4000-ES	HYD 5000-ES	HYD 6000-ES
<b>Battery Parameters</b>					
Battery Type	Lead-acid, Lithium-ion				
Nominal battery voltage	48V				
Battery voltage range	42 - 58V				
Min discharge voltage	Lithium:(according to BMS), General 46.0V				
	Lead acid: 44.0V				
Max charge voltage	Lithium-ion:(according to BMS), Max 58V				
	Lead acid: 58V				
Recommended battery capacity	200Ah (100 – 500 Ah optional)				
Recommended storage capacity	9.6 kWh				
Max charge current	60A				
Charge current range	0 – 65A programmable				
Charge curve	3 - stage adaptive with maintenance				
Max discharge current	0 – 70A programmable				
Battery protection	Over voltage protection / Over current protection / Over temperature protection				
Depth of discharge	Lithium: 0 – 80% DOD adjustable				
	Lead acid: 0 – 50% DOD adjustable				
<b>PV parameters</b>					
The max input power	3500W	4000W	4400W	5500W	6600W
Max DC power for single MPPT	2000W (160V-520V)	2400W (180V-520V)	2600W (200V-520V)	3000W (250V-520V)	3500W (300V-520V)
The max DC input voltage	600V				
Start-up DC voltage	120V				
Nominal DC Voltage	360V				
MPPT operating voltage range	90-580V				
Full load DC voltage range	160V-520V	160V-520V	200V-520V	250V-520V	300V-520V
MPPT number	2				
The max DC input current	12A/12A				
The max DC input short current	15A/15A				
PV Backfeed Current	0A/0A				
<b>AC parameters</b>					

Max output power	3000W	3680W	4000W	5000W	6000W
Max output current	13.7A	16A	18.2A	22.8A	27.3A
Output current protection(Ipeak)	29.2A	33.6A	33.6A	47.1A	54.5A
Nominal grid voltage & frequency	220V,230V,240V, 44 – 55Hz or 54 – 66Hz				
AC voltage range	180 – 276V (according to local authority requirements)				
THD	<3%				
Power factor	1default (+ / - 0.8 adjustable)				
Inrush current	0.8A / 1us				
Max output fault current	100A / 1us				
<b>System parameters</b>					
Max efficiency	Charge: 94.1% / discharge 94.3%				
Standby losses	< 5W (PV SPS)				
Topology	High frequency isolation(for bat)				
Ingress protection ratings	IP 65				
Safety protection	Anti-islanding, RCMU, ground fault monitoring				
Communication	Wi-Fi/GPRS, RS485, SD,CAN2.0				
<b>Environmental data</b>					
Ambient temperature range	-30°C to +60°C(Derating above +45°C)				
Relative humidity range	0% - 100% (no condensing)				
Protective class	Class I				
Max operating altitude	2000m				
Current transformer connection	Hard wired				
<b>General data</b>					
Noise	<25dB				
Weight	20.5kg				
Cooling	Natural convection				
Dimensions (W*H*D)	566 x 394 x 173 mm				
Display	LCD display				
Warranty	5 years or more				
<b>EPS (Emergency Power Supply) data</b>					
EPS rated power	3000VA				
EPS nominal voltage/frequency	230V, 50/60Hz				
EPS rated current	13A				
THD	<3%				
Switch time	10mS default				

## 8. Troubleshooting

Code	Name	Description	Solution
ID01	GridOVP	The grid voltage is too high	If the alarm occurs occasionally, the possible cause is that the electric grid is abnormal occasionally. HYD-ES inverter will automatically return to normal operating status when the electric grid's back to normal.
ID02	GridUVP	The grid voltage is too low	If the alarm occurs frequently, check whether the grid voltage/frequency is within the acceptable range. If yes, please check the AC circuit breaker and AC wiring of the HYD-ES inverter.
ID03	GridOFP	The grid frequency is too high	If the grid voltage/frequency is NOT within the acceptable range and AC wiring is correct, but the alarm occurs repeatedly, contact SOFAR technical support to change the grid over-voltage, under-voltage, over-frequency, under-frequency protection points after obtaining approval from the local electrical grid operator.
ID04	GridUFP	The grid frequency is too low	
ID05	BatOVP	The battery voltage is too high	If the alarm occurs occasionally, wait a while to see if the problem is solved. If the alarm occurs frequently, check whether the battery overvoltage setting is inconsistent with the battery specification.
ID07	GridLVRT fault		
ID08	PVOVP	The PV voltage is too high	Check whether too many PV modules are series connected in a PV string, thus the PV string voltage (Voc) is higher than the maximum input voltage of HYD-ES inverter. If yes, adjust the number of series connected PV modules to decrease the PV string voltage to fit the input voltage range of HYD-ES inverter. HYD-ES inverter will automatically return to normal status after correcting adjustments
ID09	HW_LLCBus_OVP	LLCBus voltage is too high and has triggered hardware protection	ID09- ID12 are internal faults of HYD-ES inverter, switch OFF HYD-ES inverter, wait for 5 minutes, then switch ON HYD-ES inverter. Check whether the problem is solved. If no, please contact SOFAR technical support.
ID10	HW_Boost_OVP	Boost voltage is too high and has triggered hardware protection	
ID11	HwBuckBoostOCP	BuckBoost current is too high and has triggered hardware protection	

ID12	HwBatOCP	The battery current is too high and has triggered hardware protection	
ID13	GFCI OCP	The GFCI sampling value between the master DSP and slave DSP is not consistent	If the fault occurs occasionally, the possible cause is that the external circuits are abnormal occasionally. HYD-ES inverter automatically returns to normal operating status after the fault is rectified.  If the fault occurs frequently and lasts a long time, check whether the insulation resistance between the PV array and earth(ground) is too low, also check the insulation conditions of PV cables.
ID14	HWPVOCP	The PV current is too high and has triggered hardware protection	ID14-ID15 are internal faults of HYD-ES inverter, switch OFF HYD-ES inverter, wait for 5 minutes, then switch ON HYD-ES inverter. Check whether the problem is solved.  If no, please contact SOFAR technical support.
ID15	HwAcOCP	The grid current is too high and has triggered hardware protection	
ID16	IpvUnbalance	Input current is not balanced	Check the <a href="#">PV input mode</a> (parallel mode/independent mode) setting of HYD-ES inverter. If it's incorrect, change the <a href="#">PV input mode</a> .
ID17	HwADFaultIGrid	The grid current sampling error	ID17-ID26 are internal faults of HYD-ES inverter, switch OFF HYD-ES inverter, wait for 5 minutes, then switch ON HYD-ES inverter. Check whether the problem is solved.  If no, please contact SOFAR technical support.
ID18	HwADFaultDCI	The DCI sampling error	
ID19	HwADFaultVGrid	The grid voltage sampling error	
ID20	GFCIDeviceFault	The GFCI sampling error	
ID21	MChip_Fault	The master chip fault	
ID22	HwAuxPowerFault	The auxiliary voltage error	
ID25	LLCBusOVP	LLCBus voltage is too high	
ID26	SwBusOVP	Bus voltage is too high and has triggered software protection	
ID27	BatOCP	Battery current is too high	If the fault occurs frequently, please contact SOFAR technical support.
ID28	DciOCP	The DCI is too high	ID28-ID31 are internal faults of HYD-ES inverter, switch OFF HYD-ES inverter, wait for 5 minutes, then switch ON HYD-ES inverter. Check whether the problem is solved.  If no, please contact SOFAR technical support.
ID29	SwOCPInstant	The grid current is too high	
ID30	BuckOCP	Buck current is too high	
ID31	AcRmsOCP	The output current is too	



		high	
ID32	SwBOCPInstant	The input current is too high	Check whether the input current is higher than the maximum input current of HYD-ES inverter, then check the input wiring, if both are correct, please contact technical support.
ID33	PvConfigSetWrong	Incorrect input mode	Check the <a href="#">PV input mode</a> (parallel mode/independent mode) setting of HYD-ES inverter. If it's incorrect, change the <a href="#">PV input mode</a> .
ID48	ConsistenFault-fault	The GFCI sampling value between the master DSP and slave DSP is not consistent	ID48-ID51 are internal faults of HYD-ES inverter, switch OFF HYD-ES inverter, wait for 5 minutes, then switch ON HYD-ES inverter. Check whether the problem is solved. If no, please contact SOFAR technical support.
ID49	ConsistentFault_Vgrid	The grid voltage sampling value between the master DSP and slave DSP is not consistent	
ID50	ConsistentFault_Fgrid	The grid frequency sampling value between the master DSP and slave DSP is not consistent	
ID51	ConsistentFault_DCI	The Dci sampling value between the master DSP and slave DSP is not consistent	
ID52	BatCommunicaton Flag	HYD-ES inverter can't communicate with Lithium battery BMS correctly.	
ID53	SpiCommLose	SPI communication is fault	ID53-ID55 are internal faults of HYD-ES inverter, switch OFF HYD-ES inverter, wait for 5 minutes, then switch ON HYD-ES inverter. Check whether the problem is solved. If no, please contact SOFAR technical support.
ID54	SciCommLose	SCI communication is fault	
ID55	RecoverRelayFail	The relays fault	
ID56	PvIsoFault	The insulation resistance is too low	Check the insulation resistance between the PV array and earth(ground), if a short circuit occurs, rectify the fault.
ID57	OverTempFault_BAT	The battery temp is too high	Please make sure HYD-ES inverter is installed in a place without direct sunlight.

ID58	OverTempFault_HeatSink	The temperature of heat sink is too high	Please make sure HYD-ES inverter is installed in a cool / well-ventilated place. Make sure the inverter is vertically installed & the ambient temperature is less than the temperature upper limit of HYD-ES inverter
ID59	OverTempFault_Env	The environment temp is too high	
ID60	PE connectFault		Check the grounding of AC output PE wire.
ID65	unrecoverHwAcOCP	The grid current is too high and has cause unrecoverable hardware fault	ID65-ID67 are internal faults of HYD-ES inverter, switch OFF HYD-ES inverter, wait for 5 minutes, then switch ON HYD-ES inverter. Check whether the problem is solved. If no, please contact SOFAR technical support.
ID66	unrecoverBusOVP	The bus voltage is too high and has cause unrecoverable fault	
ID67	BitEPSunrecoverBatOcp	Unrecoverable fault of battery overcurrent in EPS mode	
ID68	UnrecoverIpvUnbalance	The input current is unbalance, and has triggered unrecoverable fault	Check the <a href="#">PV input mode</a> (parallel mode/independent mode) setting of HYD-ES inverter. If it's incorrect, change the <a href="#">PV input mode</a> .
ID70	unrecoverOCPIinstant	The grid current is too high, and has cause unrecoverable fault	ID70-ID73 are internal faults of HYD-ES inverter, switch OFF HYD-ES inverter, wait for 5 minutes, then switch ON HYD-ES inverter. Check whether the problem is solved. If no, please contact SOFAR technical support.
ID73	UnrecoverIPVInstant	The input current is too high, and has triggered unrecoverable fault	
ID74	UnrecoverPvConfigSetWrong	Incorrect input mode	Check the <a href="#">PV input mode</a> (parallel mode/independent mode) setting of HYD-ES inverter. If it's incorrect, change the <a href="#">PV input mode</a> .
ID75	unrecoverEEPROM_W	Unrecoverable EEPROM write	ID75-ID77 are internal faults of HYD-ES inverter, switch OFF HYD-ES inverter, wait for 5 minutes, then switch ON HYD-ES inverter. Check whether the problem is solved. If no, please contact SOFAR technical support.
ID76	unrecoverEEPROM_R	Unrecoverable EEPROM read	
ID77	unrecoverRelayFail	Relay has triggered permanent fault	
ID81	Over temperature	Internal temperature is too high.	Please make sure HYD-ES inverter is installed in a place without direct sunlight. Please make sure HYD-ES inverter is installed in a cool / well-ventilated place. Make sure the inverter is vertically installed & the ambient temperature is less than the temperature upper limit of HYD-ES inverter
ID82	Over frequency	AC frequency is too high	

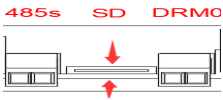
ID83	Long dist Load Shedding	Remote power derate	HYD-ES inverter receives a remote signal to decrease its power.
ID84	Long dist OFF	Switch OFF HYD series inverter remotely	HYD-ES inverter receives a remote signal to switch OFF.
ID85	SOC <= 1 -DOD or Battery voltage is low		For example, if you set DOD to 30%, when SOC is less than 70%, you will see ID85 in the event list. HYD-ES inverter won't discharge the battery when ID85 is present.  Or this is an indication of low battery voltage. HYD-ES inverter won't discharge battery in this case to ensure long battery cycle life.
ID94	Software version is not consistent		Contact SOFAR technical support to upgrade software.
ID95	CommEEPROMFault	The Communication board EEPROM is faulty	ID95-ID96 are internal faults of HYD-ES inverter, switch OFF HYD-ES inverter, wait for 5 minutes, then switch ON HYD-ES inverter. Check whether the problem is solved.  If no, please contact SOFAR technical support.
ID96	RTCFault	RTC clock chip is fault	
ID98	SDfault	The SD card is fault	Normally ID98 is caused by loose SD card holder. Click & take out SD card, press SD card holder then insert SD card back can normally solve this problem.  
ID100	BatOCD	Battery over current discharging protect	ID100-ID103 is battery fault. If this fault occurs occasionally, wait a few minutes to see whether the problem is solved.  If this fault occurs frequently, please contact SOFAR technical support.
ID101	BatSCD	Discharging short circuit protect	
ID102	BatOV	Battery high voltage protect	
ID103	BatUV	Battery low voltage protect	
ID104	BatOTD	Battery high temperature protect while discharging	Make sure battery is in a well-ventilated place.  Try to decrease the max discharge (A) or/and max charge (A) to see if the problem is solved.
ID105	BatOTC	Battery high temperature protect while charging	
ID106	BatUTD	Battery low temperature protect while discharging	Try to increase the ambient temperature of the battery.
ID107	BatUTC	Battery low temperature protect while charging	