

SUN2000-(8KTL-20KTL)-M2

User Manual

Issue 07
Date 2021-12-20



Copyright © Huawei Technologies Co., Ltd. 2021. All rights reserved.

No part of this document may be reproduced or transmitted in any form or by any means without prior written consent of Huawei Technologies Co., Ltd.

Trademarks and Permissions



HUAWEI and other Huawei trademarks are trademarks of Huawei Technologies Co., Ltd.

All other trademarks and trade names mentioned in this document are the property of their respective holders.

Notice

The purchased products, services and features are stipulated by the contract made between Huawei and the customer. All or part of the products, services and features described in this document may not be within the purchase scope or the usage scope. Unless otherwise specified in the contract, all statements, information, and recommendations in this document are provided "AS IS" without warranties, guarantees or representations of any kind, either express or implied.

The information in this document is subject to change without notice. Every effort has been made in the preparation of this document to ensure accuracy of the contents, but all statements, information, and recommendations in this document do not constitute a warranty of any kind, express or implied.

Huawei Technologies Co., Ltd.

Address: Huawei Industrial Base
Bantian, Longgang
Shenzhen 518129
People's Republic of China

Website: <https://e.huawei.com>

About This Document

Purpose

This document describes the SUN2000-8KTL-M2, SUN2000-10KTL-M2, SUN2000-12KTL-M2, SUN2000-15KTL-M2, SUN2000-17KTL-M2, and SUN2000-20KTL-M2 (SUN2000 for short) in terms of installation, electrical connections, commissioning, maintenance, and troubleshooting. Read this document through, understand the safety information, and get familiar with the functions and features of the SUN2000 before installing and operating it.

NOTE

The SUN2000-8KTL-M2 and SUN2000-10KTL-M2 inverters are applicable only to Australia.



Intended Audience



This document is intended for:

- Installers
- Users

Symbol Conventions

The symbols that may be found in this document are defined as follows.

Symbol	Description
	Indicates a hazard with a high level of risk which, if not avoided, will result in death or serious injury.
	Indicates a hazard with a medium level of risk which, if not avoided, could result in death or serious injury.
	Indicates a hazard with a low level of risk which, if not avoided, could result in minor or moderate injury.

Symbol	Description
 NOTICE	Indicates a potentially hazardous situation which, if not avoided, could result in equipment damage, data loss, performance deterioration, or unanticipated results. NOTICE is used to address practices not related to personal injury.
 NOTE	Supplements the important information in the main text. NOTE is used to address information not related to personal injury, equipment damage, and environment deterioration.

Change History

Changes between document issues are cumulative. The latest document issue contains all updates made in previous issues.

Issue 07 (2021-12-20)

- Updated [7.1.3 Creating a PV Plant and a User](#).
- Updated [7.2.1 Energy Control](#).
- Updated [10.1 SUN2000 Technical Specifications](#).

Issue 06 (2021-11-10)

Updated [10.1 SUN2000 Technical Specifications](#).

Issue 05 (2021-08-10)

- Updated [5.4 Connecting the DC input power cable](#).
- Updated [5.5 \(Optional\) Installing the Smart Dongle](#).
- Updated [5.5 \(Optional\) Installing the Smart Dongle](#).
- Updated [7 Man-Machine Interaction](#).
- Updated [B Device Commissioning](#).

Issue 04 (2021-01-21)

- Updated [10.1 SUN2000 Technical Specifications](#).
- Updated [4.3.2 Space Requirements](#).
- Updated [5.6.2 Connecting the RS485 Communications Cable \(Smart Power Sensor\)](#).

Issue 03 (2020-12-10)

- Updated [7.1.1 Downloading the FusionSolar App](#).
- Updated [7.1.3 Creating a PV Plant and a User](#).

- Updated [7.1.4 \(Optional\) Setting the Physical Layout of the Smart PV Optimizers](#).
- Updated [D Rapid Shutdown](#).

Issue 02 (2020-09-15)

- Updated [5.2 Connecting the PE cable](#).
- Updated [7.1.4 \(Optional\) Setting the Physical Layout of the Smart PV Optimizers](#).

Issue 01 (2020-07-02)

This issue is used for first office application (FOA).

Contents

About This Document.....	ii
1 Safety Information.....	1
1.1 General Safety.....	1
1.2 Personnel Requirements.....	2
1.3 Electrical Safety.....	3
1.4 Installation Environment Requirements.....	4
1.5 Mechanical Safety.....	4
1.6 Commissioning.....	6
1.7 Maintenance and Replacement.....	6
2 Overview.....	7
2.1 Product Introduction.....	7
2.2 Appearance.....	11
2.3 Label Description.....	13
2.3.1 Enclosure Labels.....	13
2.3.2 Product Nameplate.....	14
2.4 Working Principles.....	15
2.4.1 Circuit Diagram.....	15
2.4.2 Working Modes.....	15
3 Storage.....	17
4 Installation.....	18
4.1 Checking Before Installation.....	18
4.2 Tools.....	19
4.3 Determining the Installation Position.....	20
4.3.1 Environment Requirements.....	20
4.3.2 Space Requirements.....	21
4.4 Moving an Inverter.....	24
4.5 Installing the Mounting Bracket.....	24
4.5.1 Wall-mounted Installation.....	25
4.5.2 Support-mounted Installation.....	28
5 Electrical Connections.....	31
5.1 Preparing for Installation.....	32

5.2 Connecting the PE cable.....	35
5.3 Connecting the AC Output Power Cable.....	37
5.4 Connecting the DC input power cable.....	40
5.5 (Optional) Installing the Smart Dongle.....	44
5.6 (Optional) Installing the Signal Cable.....	45
5.6.1 Connecting the RS485 Communications Cable (Inverter Cascading).....	48
5.6.2 Connecting the RS485 Communications Cable (Smart Power Sensor).....	49
5.6.3 Connecting the Rapid shutdown signal cable.....	53
5.6.4 Connecting the Power Grid Scheduling Signal Cable.....	54
5.6.5 Connecting the NS Protection Signal Cable.....	55
6 Commissioning.....	58
6.1 Check Before Power-On.....	58
6.2 Powering On the System.....	59
7 Man-Machine Interaction.....	64
7.1 App Commissioning.....	64
7.1.1 Downloading the FusionSolar App.....	64
7.1.2 (Optional) Registering an Installer Account.....	65
7.1.3 Creating a PV Plant and a User.....	66
7.1.4 (Optional) Setting the Physical Layout of the Smart PV Optimizers.....	66
7.1.5 Detecting Optimizer Disconnection.....	68
7.2 Parameters Settings.....	69
7.2.1 Energy Control.....	69
7.2.1.1 Grid-tied Point Control.....	69
7.2.1.2 Apparent Power Control on the Inverter Output Side.....	74
7.2.2 AFCI.....	75
7.2.3 IPS Check (for Italy CEI0-21 Grid Code Only).....	76
7.3 SmartLogger Networking Scenario.....	78
8 Maintenance.....	79
8.1 System Power-Off.....	79
8.2 Routine Maintenance.....	80
8.3 Troubleshooting.....	80
9 Handling the Inverter.....	92
9.1 Removing a SUN2000.....	92
9.2 Packing the SUN2000.....	92
9.3 Disposing of the SUN2000.....	92
10 Technical Data.....	93
10.1 SUN2000 Technical Specifications.....	93
10.2 Optimizer Technical Specifications.....	97
A Grid Codes.....	100
B Device Commissioning.....	105

C Resetting Password.....	108
D Rapid Shutdown.....	111
E Locating Insulation Resistance Faults.....	112
F Acronyms and Abbreviations.....	115

1 Safety Information

1.1 General Safety

Statement

Before installing, operating, and maintaining the equipment, read this document and observe all the safety instructions on the equipment and in this document.

The "NOTICE", "CAUTION", "WARNING", and "DANGER" statements in this document do not cover all the safety instructions. They are only supplements to the safety instructions. Huawei will not be liable for any consequence caused by the violation of general safety requirements or design, production, and usage safety standards.

Ensure that the equipment is used in environments that meet its design specifications. Otherwise, the equipment may become faulty, and the resulting equipment malfunction, component damage, personal injuries, or property damage are not covered under the warranty.

Follow local laws and regulations when installing, operating, or maintaining the equipment. The safety instructions in this document are only supplements to local laws and regulations.

Huawei will not be liable for any consequences of the following circumstances:

- Operation beyond the conditions specified in this document
- Installation or use in environments which are not specified in relevant international or national standards
- Unauthorized modifications to the product or software code or removal of the product
- Failure to follow the operation instructions and safety precautions on the product and in this document
- Equipment damage due to force majeure, such as earthquakes, fire, and storms
- Damage caused during transportation by the customer
- Storage conditions that do not meet the requirements specified in this document

General Requirements



Do not work with power on during installation.

- Do not install, use, or operate outdoor equipment and cables (including but not limited to moving equipment, operating equipment and cables, inserting connectors to or removing connectors from signal ports connected to outdoor facilities, working at heights, and performing outdoor installation) in harsh weather conditions such as lightning, rain, snow, and level 6 or stronger wind.
- After installing the equipment, remove idle packing materials such as cartons, foam, plastics, and cable ties from the equipment area.
- In the case of a fire, immediately leave the building or the equipment area, and turn on the fire alarm bell or make an emergency call. Do not enter the building on fire in any case.
- Do not scrawl, damage, or block any warning label on the equipment.
- Tighten the screws to the specified torque using tools when installing the equipment.
- Understand the components and functioning of a grid-tied PV power system and relevant local standards.
- Repaint any paint scratches caused during equipment transportation or installation in a timely manner. Equipment with scratches cannot be exposed to an outdoor environment for a long period of time.
- Do not open the host panel of the equipment.
- You shall not reverse engineer, decompile, disassemble, adapt, add code to the device software or alter the device software in any other way, research the internal implementation of the device, obtain the device software source code, infringe on Huawei's intellectual property, or disclose any device software performance test results.

Personal Safety

- If there is a probability of personal injury or equipment damage during operations on the equipment, immediately stop the operations, report the case to the supervisor, and take feasible protective measures.
- Use tools correctly to avoid hurting people or damaging the equipment.
- Do not touch the energized equipment, as the enclosure is hot.

1.2 Personnel Requirements

- Personnel who plan to install or maintain Huawei equipment must receive thorough training, understand all necessary safety precautions, and be able to correctly perform all operations.
- Only qualified professionals or trained personnel are allowed to install, operate, and maintain the equipment.
- Only qualified professionals are allowed to remove safety facilities and inspect the equipment.

- Personnel who will operate the equipment, including operators, trained personnel, and professionals, should possess the local national required qualifications in special operations such as high-voltage operations, working at heights, and operations of special equipment.
- Only professionals or authorized personnel are allowed to replace the equipment or components (including software).

 **NOTE**

- Professionals: personnel who are trained or experienced in equipment operations and are clear of the sources and degree of various potential hazards in equipment installation, operation, and maintenance
- Trained personnel: personnel who are technically trained, have required experience, are aware of possible hazards on themselves in certain operations, and are able to take protective measures to minimize the hazards on themselves and other people
- Operators: operation personnel who may come in contact with the equipment, except trained personnel and professionals

1.3 Electrical Safety

Grounding

- For the equipment that needs to be grounded, install the ground cable first when installing the equipment and remove the ground cable last when removing the equipment.
- Do not damage the ground conductor.
- Do not operate the equipment in the absence of a properly installed ground conductor.
- Ensure that the equipment is connected permanently to the protective ground. Before operating the equipment, check its electrical connection to ensure that it is securely grounded.

General Requirements

 **DANGER**

Before connecting cables, ensure that the equipment is intact. Otherwise, electric shocks or fire may occur.

- Ensure that all electrical connections comply with local electrical standards.
- Obtain approval from the local electric utility company before using the equipment in grid-tied mode.
- Ensure that the cables you prepared meet local regulations.
- Use dedicated insulated tools when performing high-voltage operations.

AC and DC Power

 **DANGER**

Do not connect or disconnect power cables with power on. Transient contact between the core of the power cable and the conductor will generate electric arcs or sparks, which may cause fire or personal injury.

- Before making electrical connections, switch off the disconnecter on the upstream device to cut off the power supply if people may contact energized components.
- Before connecting a power cable, check that the label on the power cable is correct.
- If the equipment has multiple inputs, disconnect all the inputs before operating the equipment.

Cabling

- When routing cables, ensure that a distance of at least 30 mm exists between the cables and heat-generating components or areas. This prevents damage to the insulation layer of the cables.
- Bind cables of the same type together. When routing cables of different types, ensure that they are at least 30 mm away from each other.
- Ensure that the cables used in a grid-tied PV power system are properly connected and insulated and meet specifications.

1.4 Installation Environment Requirements

- Ensure that the equipment is installed in a well ventilated environment.
- To prevent fire due to high temperature, ensure that the ventilation vents or heat dissipation system are not blocked when the equipment is running.
- Do not expose the equipment to flammable or explosive gas or smoke. Do not perform any operation on the equipment in such environments.

1.5 Mechanical Safety

Using Ladders

- Use wooden or fiberglass ladders when you need to perform live working at heights.
- When a step ladder is used, ensure that the pull ropes are secured and the ladder is held firm.
- Before using a ladder, check that it is intact and confirm its load bearing capacity. Do not overload it.
- Ensure that the wider end of the ladder is at the bottom, or protective measures have been taken at the bottom to prevent the ladder from sliding.

- Ensure that the ladder is securely positioned. The recommended angle for a ladder against the floor is 75 degrees, as shown in the following figure. An angle rule can be used to measure the angle.

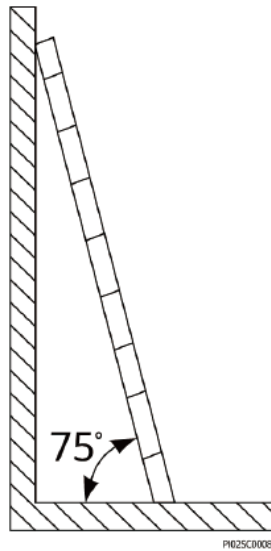

- When climbing a ladder, take the following precautions to reduce risks and ensure safety:
 - Keep your body steady.
 - Do not climb higher than the fourth rung of the ladder from the top.
 - Ensure that your body's center of gravity does not shift outside the legs of the ladder.

Drilling Holes

When drilling holes into a wall or floor, observe the following safety precautions:

- Wear goggles and protective gloves when drilling holes.
- When drilling holes, protect the equipment from shavings. After drilling, clean up any shavings that have accumulated inside or outside the equipment.

Moving Heavy Objects

- Be cautious to avoid injury when moving heavy objects.

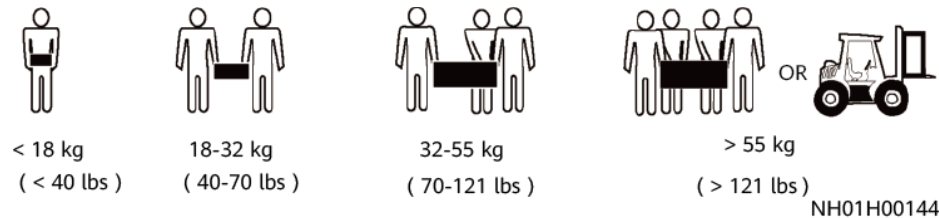

- When moving the equipment by hand, wear protective gloves to prevent injuries.

1.6 Commissioning

When the equipment is powered on for the first time, ensure that professional personnel set parameters correctly. Incorrect settings may result in inconsistency with local certification and affect the normal operation of the equipment.

1.7 Maintenance and Replacement

 **DANGER**

High voltage generated by the equipment during operation may cause an electric shock, which could result in death, serious injury, or serious property damage. Prior to maintenance, power off the equipment and strictly comply with the safety precautions in this document and relevant documents.

-
- Maintain the equipment with sufficient knowledge of this document and using proper tools and testing equipment.
 - Before maintaining the equipment, power it off and follow the instructions on the delayed discharge label to ensure that the equipment is powered off.
 - Turn off the AC and DC switches of the SUN2000 when maintaining the electric equipment or power distribution equipment connected the SUN2000.
 - Place temporary warning signs or erect fences to prevent unauthorized access to the maintenance site.
 - If the equipment is faulty, contact your dealer.
 - The equipment can be powered on only after all faults are rectified. Failing to do so may escalate faults or damage the equipment.

2 Overview

2.1 Product Introduction

Function

The SUN2000 is a three-phase grid-tied PV string inverter that converts the DC power generated by PV strings into AC power and feeds the power into the power grid.

Models

This document involves the following product models:

- SUN2000-8KTL-M2
- SUN2000-10KTL-M2
- SUN2000-12KTL-M2
- SUN2000-15KTL-M2
- SUN2000-17KTL-M2
- SUN2000-20KTL-M2

NOTE

The SUN2000-8KTL-M2 and SUN2000-10KTL-M2 inverters are applicable only to Australia.

Figure 2-1 Model description (SUN2000-20KTL-M2 is used as an example)

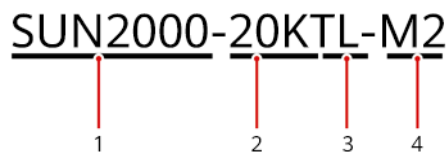

Table 2-1 Model description

Icon	Meaning	Description
1	Product	SUN2000: three-phase grid-tied PV string inverter
2	Power level	<ul style="list-style-type: none"> • 8K: The rated power is 8 kW. • 10K: The rated power is 10 kW. • 12K: The rated power is 12 kW. • 15K: The rated power is 15 kW. • 17K: The rated power is 17 kW. • 20K: The rated power is 20 kW.
3	Topology	TL: transformerless
4	Product code	M2: the product series with the 1080 V DC input voltage

Network Application

The SUN2000 applies to grid-tied PV systems for residential rooftops and small ground plants. Typically, a grid-tied system consists of the PV string, SUN2000, AC switch, and alternating current distribution unit (ACDU).

Figure 2-2 Networking application - Single inverter scenario (optional in dashed boxes)

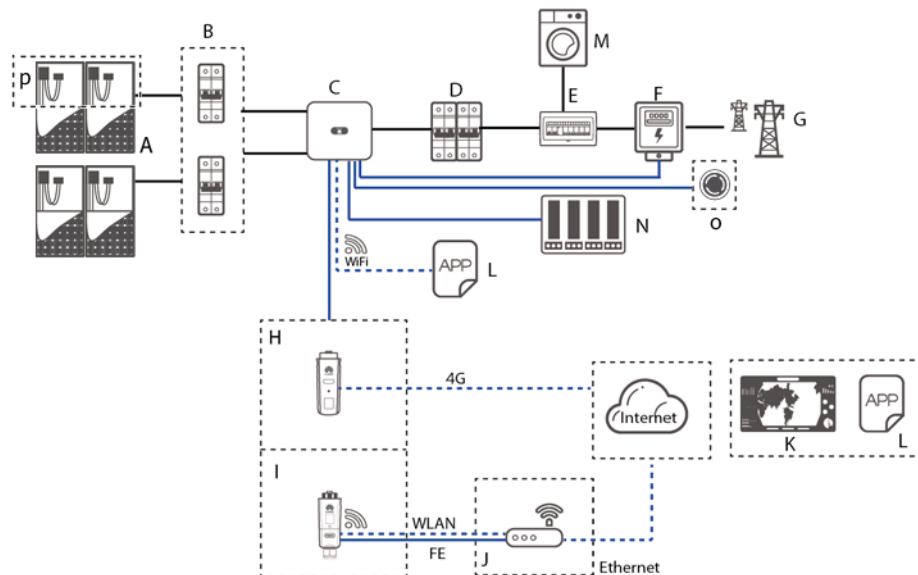
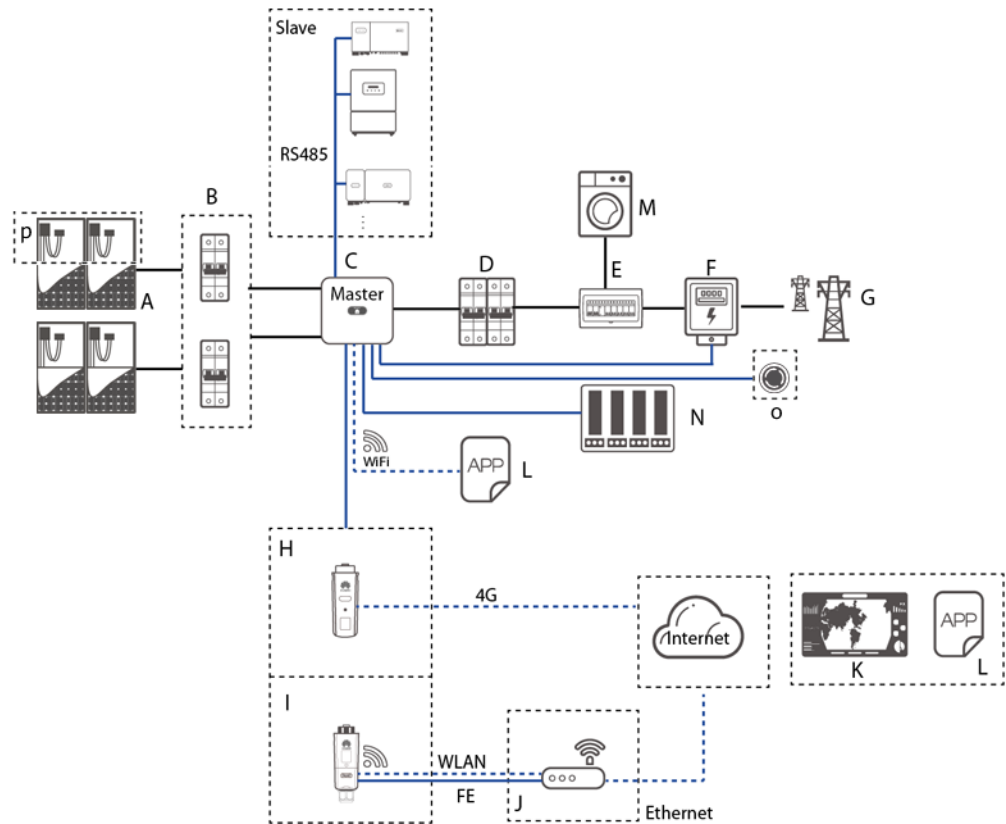

Figure 2-3 Networking application - Inverter cascading scenario (optional in dashed boxes)



NOTE

- indicates a power cable, — indicates a signal cable, indicates wireless communication.
- If the inverter is connected to the FusionSolar app over its built-in WiFi network, only local commissioning can be performed.
- In the RS485 cascading communication networking, the master inverter model is SUN2000-(3KTL-20KTL)-M2 and SUN2000-(3KTL-20KTL)-M0, and the slave inverter model can be SUN2000-(3KTL-20KTL)-M2, SUN2000-(3KTL-20KTL)-M0, SUN2000-50KTL/60KTL/65KTL-M0, SUN2000-29.9KTL/36KTL, or SUN2000-33KTL-A.

- | | | |
|------------------------|-----------------------------------|---------------------------|
| (A) PV string | (B) DC switch | (C) SUN2000 |
| (D) AC switch | (E) ACDU | (F) Smart Power Sensor |
| (G) Power grid | (H) 4G Smart Dongle | (I) WLAN-FE Smart Dongle |
| (J) Router | (K) FusionSolar management system | (L) FusionSolar APP |
| (M) Load | (N) Ripple Control Device | (O) Rapid shutdown switch |
| (P) Smart PV optimizer | | |

 NOTE

For detailed operations on devices in the network, see the following guides:

[SUN2000-450W-P Smart PV Optimizer Quick Guide](#)

Supported Power Grids

Power grid types supported by the SUN2000 include TN-S, TN-C, TN-C-S, TT, and IT.

Figure 2-4 Supported power grids

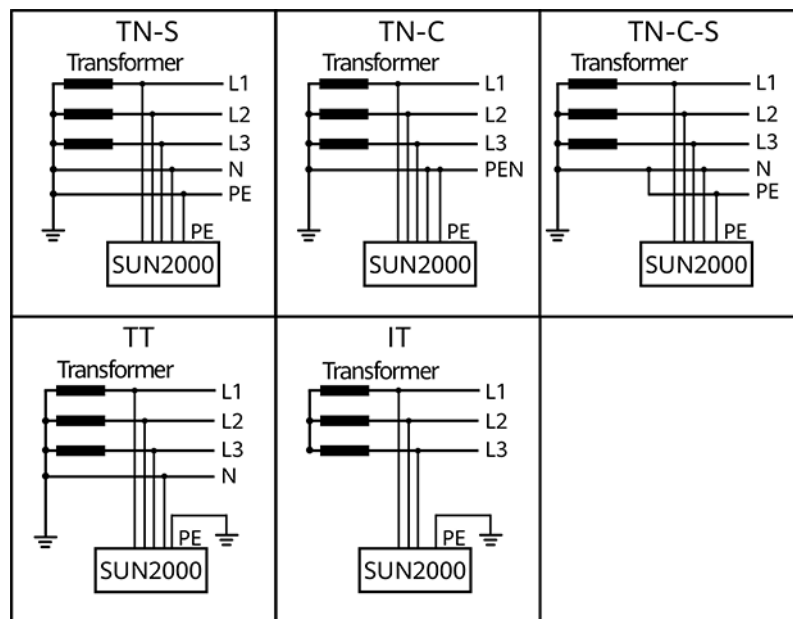

IS01S10001

 NOTE

- In a TT power grid, the N-PE voltage should be lower than 30 V.
- In an IT power grid, you need to set **isolation settings to input not grounded, with a transformer.**

2.2 Appearance

Figure 2-5 Appearance

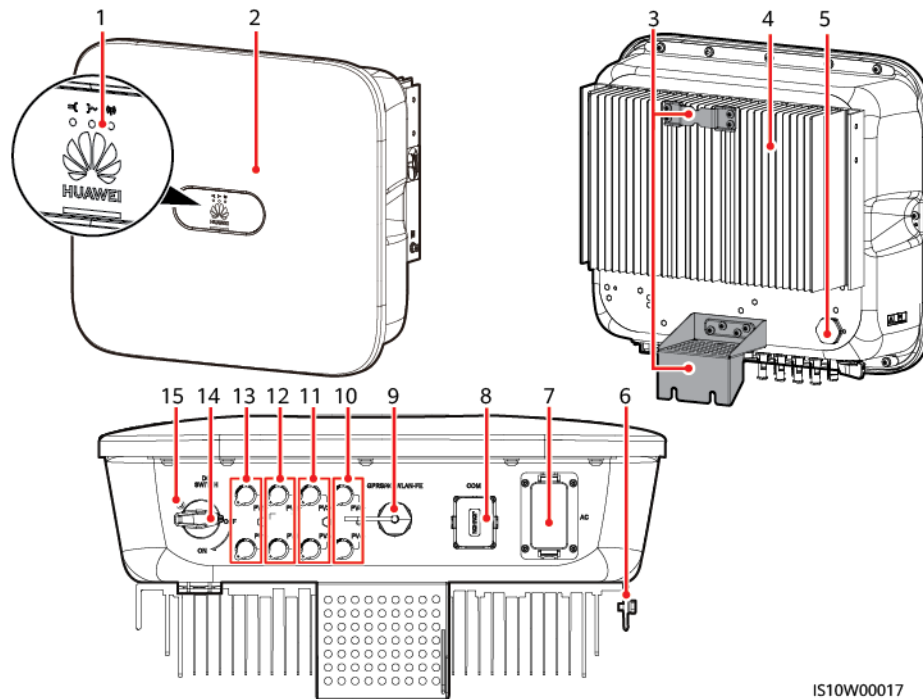

IS10W00017

- | | |
|--|-------------------------------------|
| (1) LED indicator | (2) Front panel |
| (3) Mounting plate | (4) Heat sink |
| (5) Ventilation valve | (6) Ground screw |
| (7) AC output port (AC) | (8) Communication port (COM) |
| (9) Smart Dongle port (GPRS/4G/
WLAN-FE) | (10) DC input terminals (PV4+/PV4-) |
| (11) DC input terminals (PV3+/PV3-) | (12) DC input terminals (PV2+/PV2-) |
| (13) DC input terminals (PV1+/PV1-) | (14) DC switch (DC SWITCH) |
| (15) Screw hole for the DC switch (for Australia only) | |



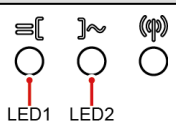
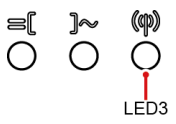

Table 2-2 LED indicator description





Category	Status		Meaning
Running indication	LED1	LED2	N/A
	Steady green	Steady green	The SUN2000 is operating in grid-tied mode.

Category	Status			Meaning
 <p>LED1 LED2</p>	Blinking green at long intervals (on for 1s and then off for 1s)	Off		The DC is on and the AC is off.
	Blinking green at long intervals (on for 1s and then off for 1s)	Blinking green at long intervals (on for 1s and then off for 1s)		The DC is on, the AC is on, and the SUN2000 is not exporting power to the power grid.
	Off	Blinking green at long intervals (on for 1s and then off for 1s)		The DC is off and the AC is on.
	Off	Off		Both the DC and AC are off.
	Blinking red at short intervals (on for 0.2s and then off for 0.2s)	N/A		There is a DC environmental alarm, such as an alarm indicating that High String Input Voltage, String Reverse Connection, or Low Insulation Resistance.
	N/A	Blinking red at short intervals (on for 0.2s and then off for 0.2s)		There is an AC environmental alarm, such as an alarm indicating Grid Undervoltage, Grid Overvoltage, Grid Overfrequency, or Grid Underfrequency.
	Steady red	Steady red		Fault
Communication indication  <p>LED3</p>	LED3			N/A
	Blinking green at short intervals (on for 0.2s and then off for 0.2s)			Communication is in progress. (When a mobile phone is connected to the SUN2000, the indicator first indicates that the phone is connected to the SUN2000): blinks green at long intervals.)
	Blinking green at long intervals (on for 1s and then off for 1s)			The mobile phone is connected to the SUN2000.
	Off			There is no communication.
Device replacement indication	LED1	LED2	LED3	N/A
	Steady red	Steady red	Steady red	The SUN2000 hardware is faulty. The SUN2000 needs to be replaced.

2.3 Label Description

2.3.1 Enclosure Labels

Symbol	Name	Meaning
	Delayed discharge	Residual voltage exists after the SUN2000 is powered off. It takes 5 minutes for the SUN2000 to discharge to the safe voltage.
	Burn warning	Do not touch an operating SUN2000 because it generates high temperatures on the shell.
	Electric shock warning label	<ul style="list-style-type: none"> High voltage exists after the SUN2000 is powered on. Only qualified and trained electrical technicians are allowed to perform operations on the SUN2000. High touch current exists after the SUN2000 is powered on. Ensure that the SUN2000 has been grounded before powering on it.
	Refer to documentation	Reminds operators to refer to the documents shipped with the SUN2000.
	Grounding	Indicates the position for connecting the protective earthing (PE) cable.

Symbol	Name	Meaning
 Do not disconnect under load! 禁止带负荷断开连接!	Operation warning	Do not remove the DC input connector or the AC output connector when the SUN2000 is running.
 (1P)PN/ITEM:XXXXXXXXXX (32P)Model: SUN2000-XKTL-M2 (S)SN:XXXXXXXXXXXXX MADE IN CHINA	SUN2000 serial number (SN) label	Indicates the SUN2000 SN.
 MAC: xxxxxxxxxxxxxx	SUN2000 MAC address label	Indicates the MAC address.
	QR code label for SUN2000 Wi-Fi connection	Scan the QR code to connect to Huawei SUN2000 Wi-Fi network.

2.3.2 Product Nameplate

Figure 2-6 Nameplate (SUN2000-20KTL-M2 as an example)

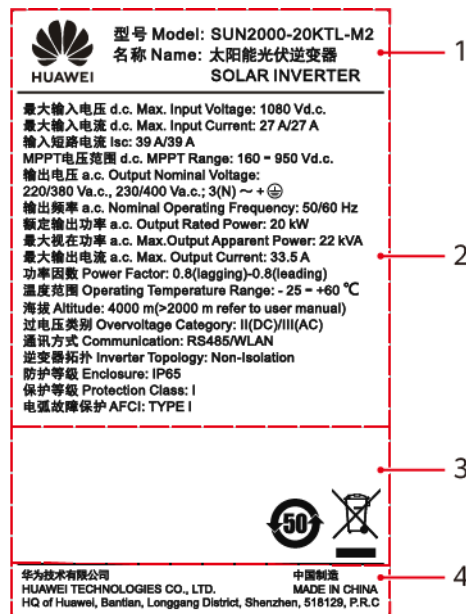

(1) Trademark and product model

(2) Important technical specifications

(3) Compliance symbols

(4) Company name and country of manufacture

 NOTE

The nameplate figure is for reference only.

2.4 Working Principles

2.4.1 Circuit Diagram

Four PV strings connect to the SUN2000, and their maximum power points are tracked by two maximum power point tracking (MPPT) circuits. The SUN2000 converts DC power into three-phase AC power through an inverter circuit. Surge protection is supported on both the DC and AC sides.

Figure 2-7 SUN2000 conceptual diagram

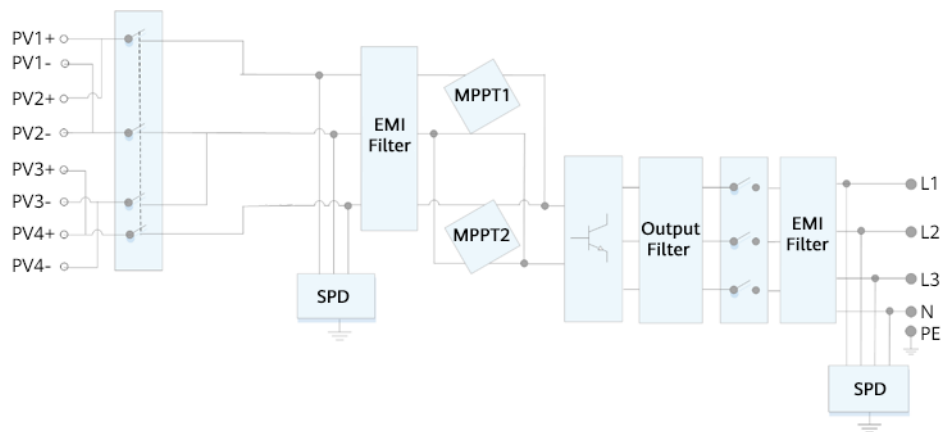

2.4.2 Working Modes

The SUN2000 can work in Standby, Operating, or Shutdown mode.

Figure 2-8 Working modes

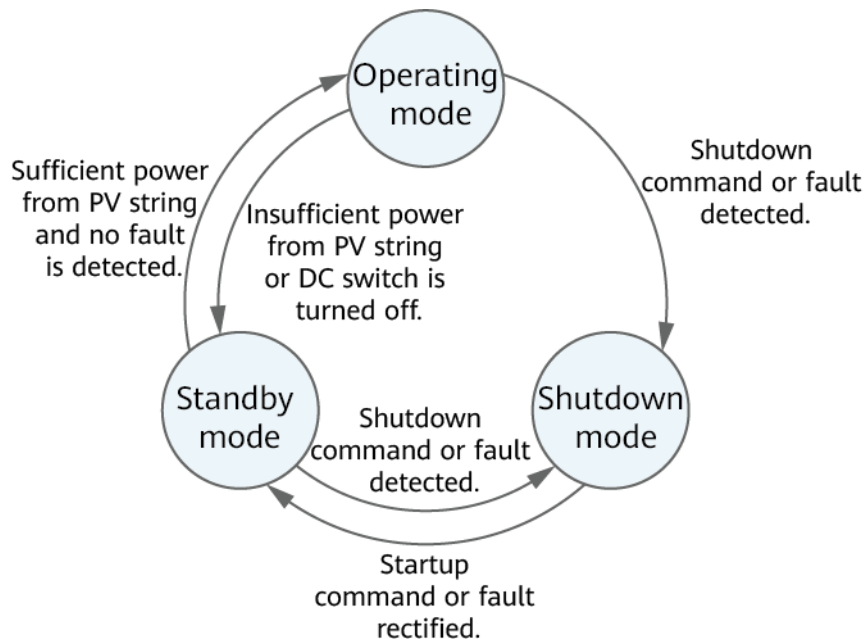

IS07500001

Table 2-3 Working mode description

Working Mode	Description
Standby	<p>The SUN2000 enters Standby mode when the external environment does not meet the operating requirements. In Standby mode:</p> <ul style="list-style-type: none"> • The SUN2000 continuously performs status check and enters the Operating mode once the operating requirements are met. • The SUN2000 enters Shutdown mode after detecting a shutdown command or a fault after startup.
Operating	<p>In Operating mode:</p> <ul style="list-style-type: none"> • The SUN2000 converts DC power from PV strings into AC power and feeds the power to the power grid. • The SUN2000 tracks the maximum power point to maximize the PV string output. • If the SUN2000 detects a fault or a shutdown command, it enters the Shutdown mode. • The SUN2000 enters Standby mode after detecting that the PV string output power is not suitable for connecting to the power grid for generating power.
Shutdown	<ul style="list-style-type: none"> • In Standby or Operating mode, the SUN2000 enters Shutdown mode after detecting a fault or shutdown command. • In Shutdown mode, the SUN2000 enters Standby mode after detecting a startup command or that the fault is rectified.

3 Storage

The following requirements should be met if the SUN2000 is not put into use directly:

- Do not unpack the SUN2000.
- Keep the storage temperature at -40°C to $+70^{\circ}\text{C}$ and the humidity at 5%–95% RH (non-condensing).
- The SUN2000 should be stored in a clean and dry place and be protected from dust and water vapor corrosion.
- A maximum of six SUN2000s can be stacked. To avoid personal injury or device damage, stack SUN2000s with caution to prevent them from falling over.
- Periodic inspections are required during the storage. Replace the packing materials if necessary.
- If the SUN2000 has been long-term stored, inspections and tests should be conducted by qualified personnel before it is put into use.

4 Installation

4.1 Checking Before Installation

Outer Packing Materials

Before unpacking the inverter, check the outer packing materials for damage, such as holes and cracks, and check the inverter model. If any damage is found or the inverter model is not what you requested, do not unpack the package and contact your supplier as soon as possible.

 **NOTE**

You are advised to remove the packing materials within 24 hours before installing the inverter.









Package Contents

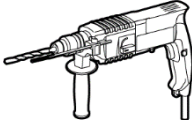
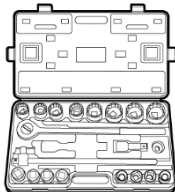
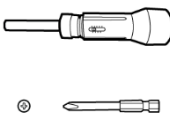
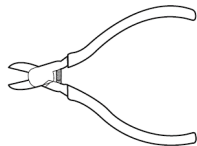
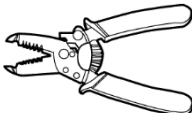

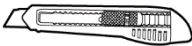
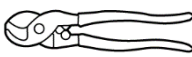
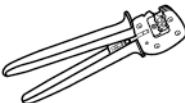

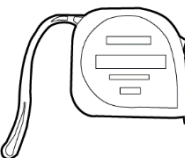

After unpacking the inverter, check that the contents are intact and complete. If any damage is found or any component is missing, contact your supplier.

 **NOTE**

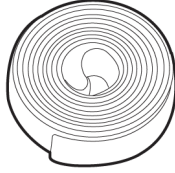
For details about the number of contents, see the *Packing List* in the packing case.

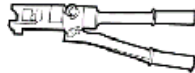
4.2 Tools

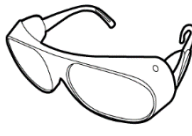
Type	Tool			
Installation Tools	 Hammer drill Drill bit: $\Phi 8$ mm and $\Phi 6$ mm	 Socket wrench set	 Torque screwdriver Phillips head: M3	 Diagonal pliers
	 Wire stripper	 Removal wrench Model: PV-MS-HZ Open-end Wrench; manufacturer: Staubli	 Rubber mallet	 Utility knife
	 Cable cutter	 Crimping tool Model: PV-CZM-22100/19100; manufacturer: Staubli	 Multimeter DC voltage measurement range ≥ 1100 V DC	 Vacuum cleaner
	 Marker	 Measuring tape	 Bubble or digital level	 Cord end terminal crimper

Type	Tool			
	 Heat shrink tubing	 Heat gun	 Cable tie	 Hydraulic pliers
PPE	 Safety gloves	 Safety goggles	 Dust mask	 Safety shoes

4.3 Determining the Installation Position

4.3.1 Environment Requirements

Basic Requirements

- The SUN2000 is protected to IP65 and can be installed indoors or outdoors.
- Do not install the SUN2000 in a place where personnel are easy to come into contact with its enclosure and heat sinks, because these parts are extremely hot during operation.
- Do not install the SUN2000 in areas with flammable or explosive materials.
- Do not install the SUN2000 at a place within children's reach.
- Do not install the SUN2000 outdoors in salt areas because it will be corroded there and may cause fire. A salt area refers to the region within 500 meters from the coast or prone to sea breeze. The regions prone to sea breeze vary depending on weather conditions (such as typhoons and monsoons) or terrains (such as dams and hills).
- The SUN2000 must be installed in a well-ventilated environment to ensure good heat dissipation.
- Recommended: Install the SUN2000 in a sheltered place or a place with an awning.

Mounting Structure Requirements

- The mounting structure where the SUN2000 is installed must be fireproof.
- Do not install the SUN2000 on flammable building materials.
- The SUN2000 is heavy. Ensure that the installation surface is solid enough to bear the weight load.

- In residential areas, do not install the SUN2000 on drywalls or walls made of similar materials which have a weak sound insulation performance because the noise generated by the SUN2000 is noticeable.

4.3.2 Space Requirements

Installation Angle Requirements

The SUN2000 can be wall-mounted or pole-mounted. The installation angle requirements are as follows:

- Install the SUN2000 vertically or at a maximum back tilt of 15 degrees to facilitate heat dissipation.
- Do not install the SUN2000 at forward tilted, excessive back tilted, side tilted, horizontal, or upside down positions.

Figure 4-1 Installation tilts

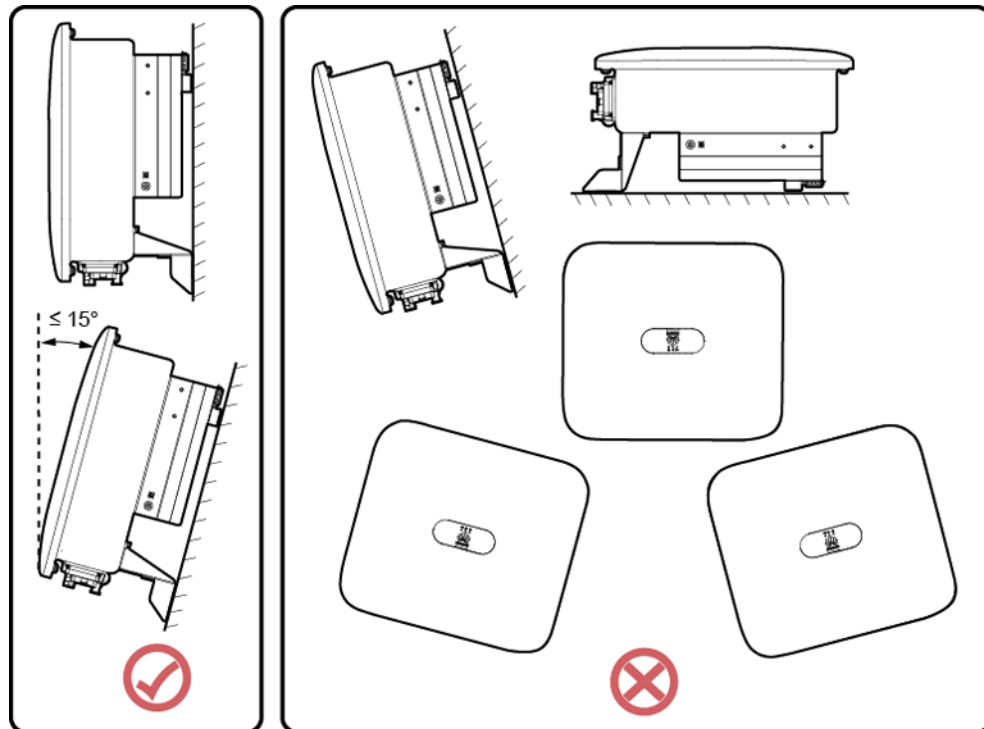

IS10H00040

Installation Space Requirements

- Reserve enough space around the SUN2000 to ensure sufficient space for installation and heat dissipation.

Figure 4-2 Installation space

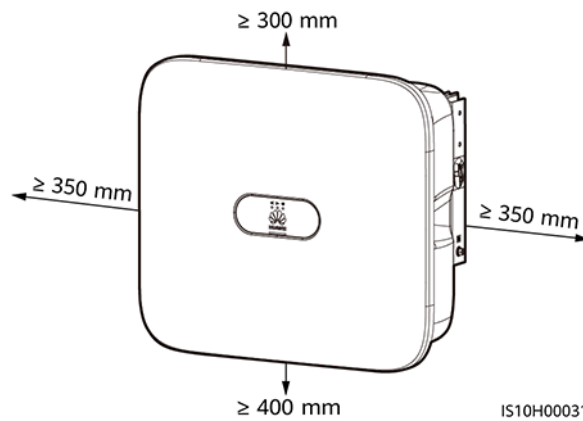

- When installing multiple SUN2000s, install them in horizontal mode if sufficient space is available and install them in triangle mode if no sufficient space is available. Stacked installation is not recommended.

Figure 4-3 Horizontal installation (recommended)

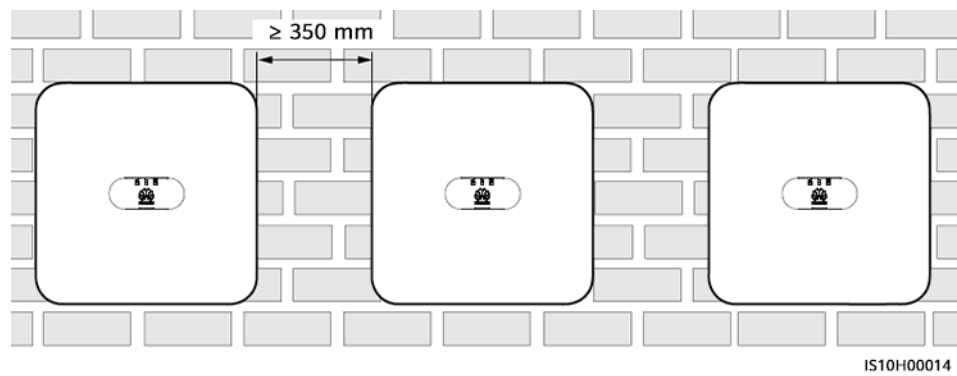

Figure 4-4 Staggered installation (recommended)

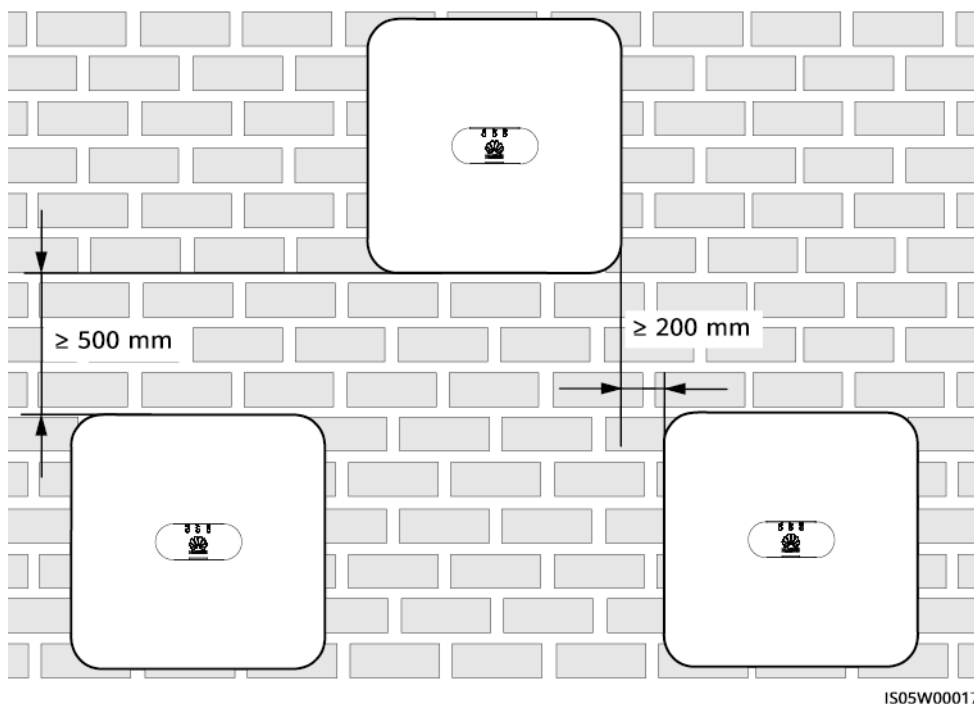
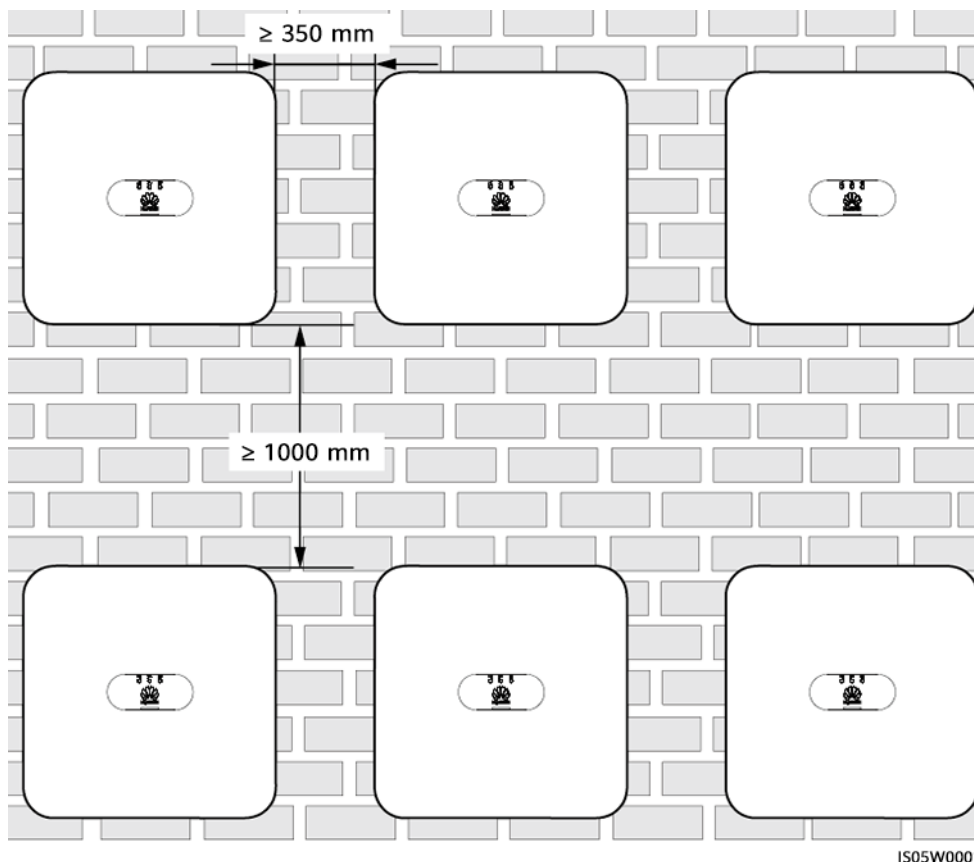

Figure 4-5 Stacked installation (not recommended)



4.4 Moving an Inverter

Procedure

- Step 1** Two persons are required to move the inverter and one person on both sides. Lift the inverter from the packing case and move it to the specified installation position.

CAUTION

- To prevent personal injury and damage to the device, take care to keep your balance when moving the SUN2000.
 - Do not use the wiring terminals and ports at the bottom to support any weight of the SUN2000.
 - When you need to temporarily place the SUN2000 on the ground, use foam, paper or other protective materials to prevent damage to its enclosure.
-

Figure 4-6 Moving an inverter

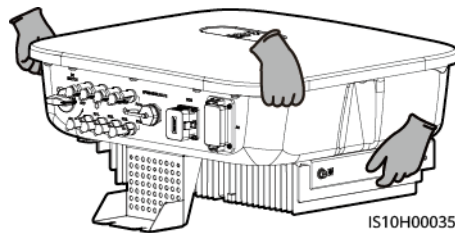

----End

4.5 Installing the Mounting Bracket

Installation Precautions

Figure 4-7 shows the dimensions of installation holes on the SUN2000.

Figure 4-7 Mounting bracket dimensions

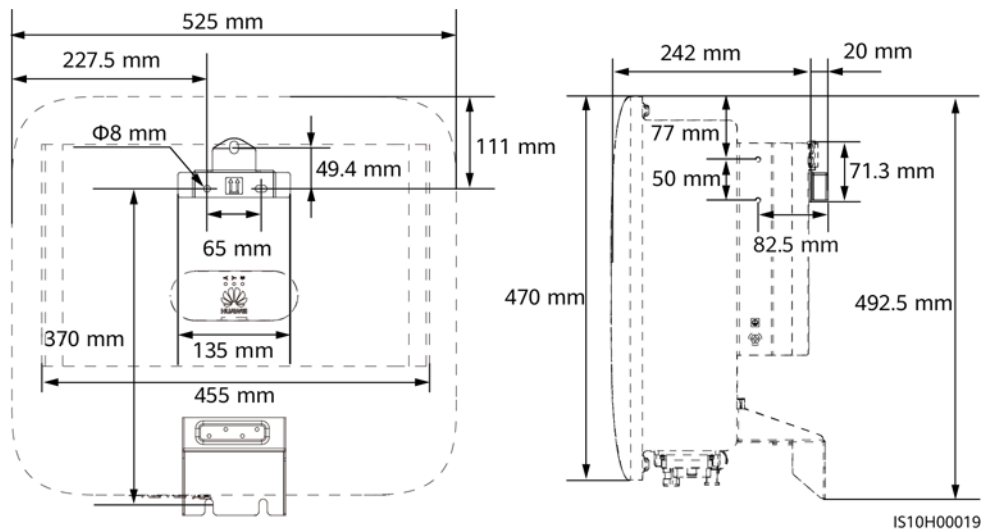

NOTE

Two M6 screw holes are reserved on both left and right sides of the enclosure for installing an awning.

4.5.1 Wall-mounted Installation

Procedure

Step 1 Determine the installation positions for drilling holes, and mark the positions using a marker.

Step 2 Secure the mounting brackets.

NOTE

- M6x60 expansion bolts are delivered with the SUN2000. If the length and amount of the bolts do not meet installation requirements, prepare M6 stainless steel expansion bolts by yourself.
- The expansion bolts delivered with the inverter are used for solid concrete walls. For other types of walls, prepare bolts by yourself and ensure that the wall meets the load bearing requirements of the inverter.

Figure 4-8 Expansion bolt composition

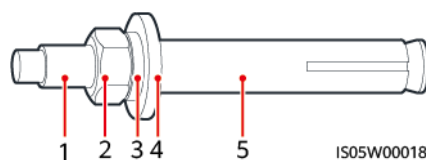

- | | | |
|-----------------|--------------------|-------------------|
| (1) Bolt | (2) Nut | (3) Spring washer |
| (4) Flat washer | (5) Expansion tube | |

⚠ DANGER

Avoid drilling holes in the utility pipes or cables attached to the back of the wall.

NOTICE

- To prevent dust inhalation or contact with eyes, wear safety goggles and an anti-dust respirator when drilling holes.
- Clean up any dust in and around the holes using a vacuum cleaner and measure the distance between holes. If large hole tolerance exists, position and drill holes again.
- After removing the bolt, spring washer, and flat washer, level the front of the expansion tube with the concrete wall. Otherwise, the mounting brackets will not stay steady on the concrete wall.
- Partially loosen the nut, flat washer and spring washer of the two expansion bolts below.

Figure 4-9 Installing the Mounting Bracket

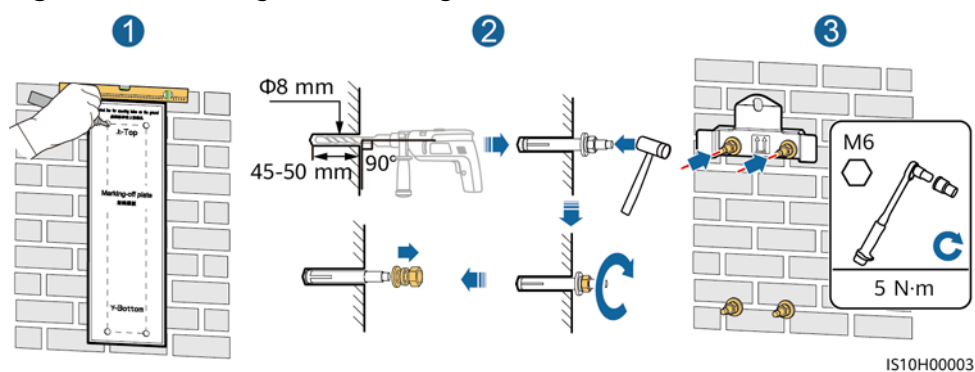

IS10H00003

Step 3 (Optional) Install the locking screw for the DC switch.

NOTE

- The screws for DC switches are delivered with solar inverters. According to Australian standards, the screws are used to secure DC switches (DC SWITCH) to prevent them from being turned on by mistake.
- For the model used in Australia, perform this step to meet the local standards.

Figure 4-10 Installing a locking screw for the DC switch

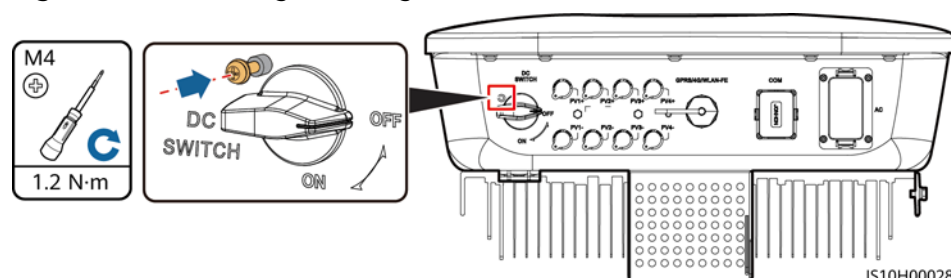

IS10H00028

Step 4 Install the SUN2000 onto the mounting bracket.

Step 5 Tighten nuts.

Figure 4-11 Installing the SUN2000

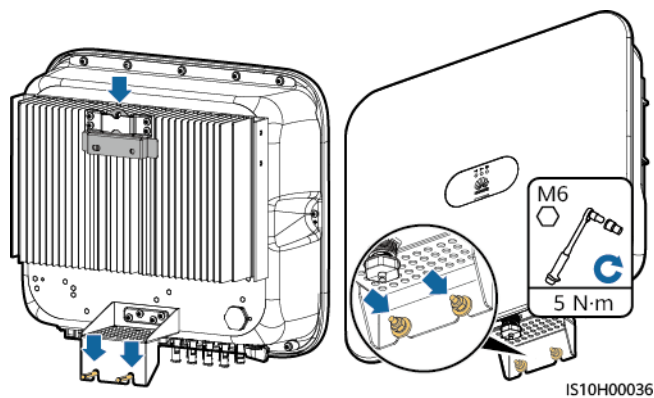

Step 6 (Optional) Install the anti-theft lock.

NOTICE

- Prepare an anti-theft lock suitable for the lock hole diameter ($\Phi 8$ mm) by yourself.
 - An outdoor waterproof lock is recommended.
 - Keep the key to the anti-theft lock safe.
-

Figure 4-12 Installing the anti-theft lock

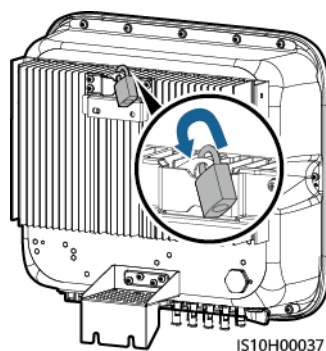

----End

4.5.2 Support-mounted Installation

Prerequisites

Prepare M6 stainless bolt assemblies (including flat washers, spring washers, and M6 bolts) with appropriate lengths as well as matched flat washers and nuts based on the support specifications.

Procedure

- Step 1** Determine the hole positions based on the marking-off template, and then mark the hole positions using a marker.

Figure 4-13 Determining hole positions

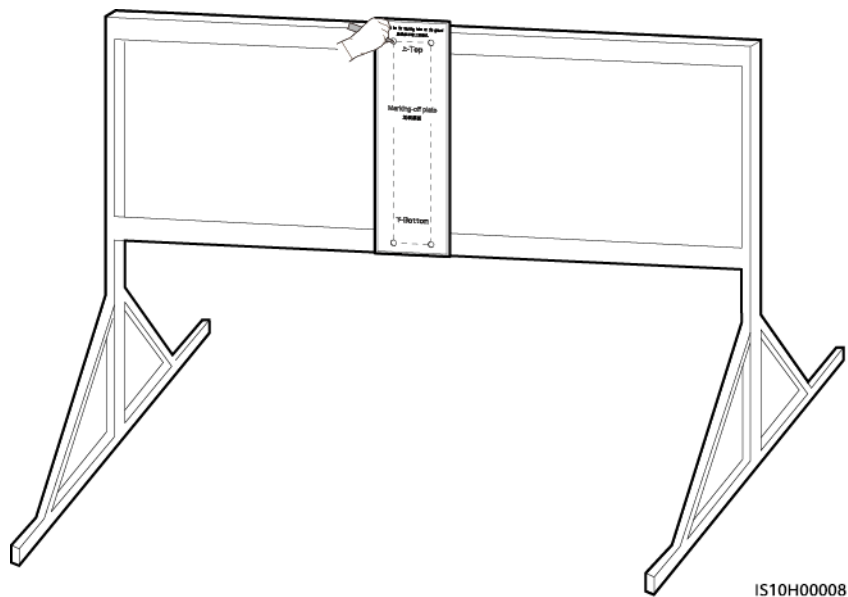

- Step 2** Drill holes using a hammer drill.

NOTE

You are advised to apply anti-rust paint on the hole positions for protection.

Figure 4-14 Drilling holes

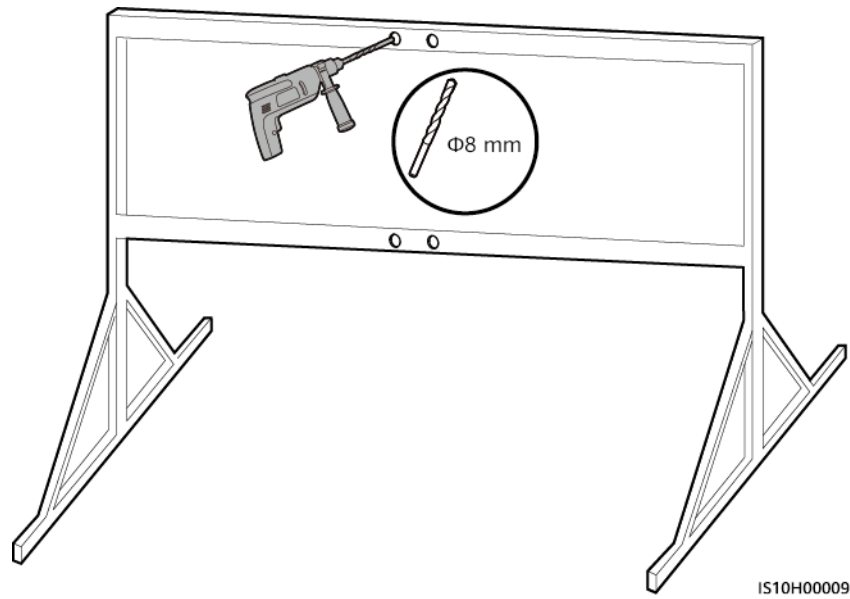

IS10H00009

Step 3 Secure the mounting bracket.

Figure 4-15 Securing the mounting bracket

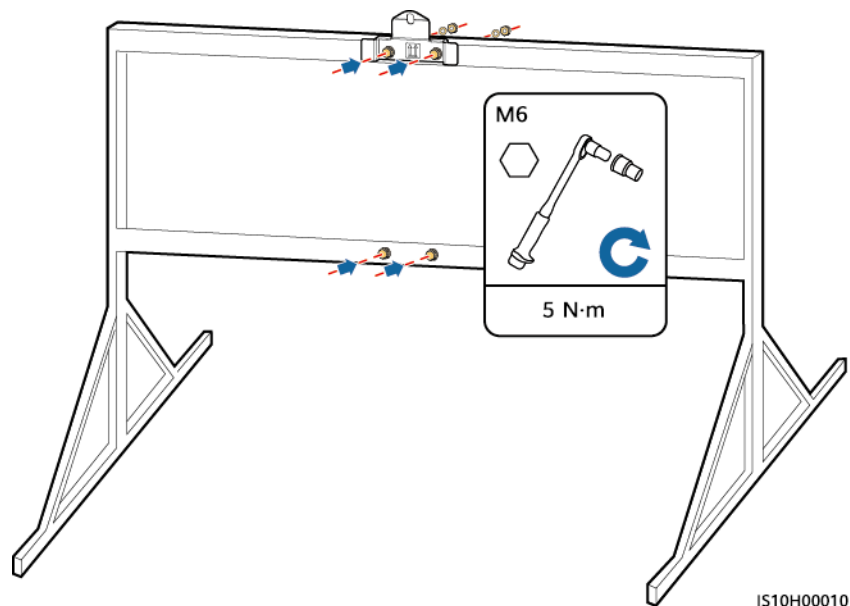

IS10H00010

Step 4 Install the SUN2000 onto the mounting bracket.

Step 5 Tighten the bolt assembly.

Figure 4-16 Installing the SUN2000

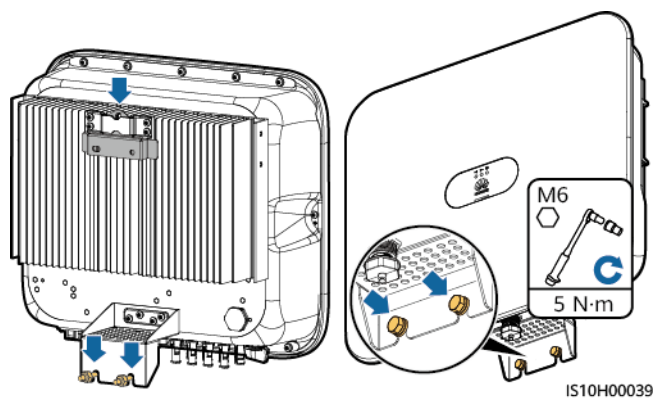

Step 6 (Optional) Install the anti-theft lock.

NOTICE

- Prepare an anti-theft lock suitable for the lock hole diameter ($\Phi 8$ mm) by yourself.
 - An outdoor waterproof lock is recommended.
 - Keep the key to the anti-theft lock safe.
-

Figure 4-17 Installing the anti-theft lock

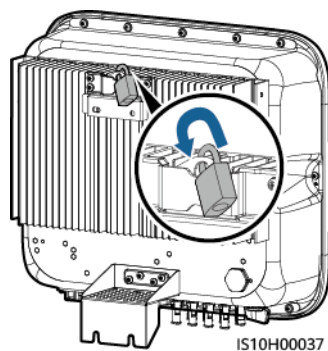

----End

5 Electrical Connections

Precautions

 **DANGER**

Before connecting cables, ensure that the DC switch on the SUN2000 and all the switches connecting to the SUN2000 are OFF. Otherwise, the high voltage of the SUN2000 may result in electric shocks.

 **WARNING**

- The equipment damage caused by incorrect cable connections is beyond the warranty scope.
 - Only certified electricians are allowed to connect cables.
 - Operation personnel must wear proper PPE when connecting cables.
-

 **NOTE**

The cable colors shown in the electrical connection diagrams provided in this chapter are for reference only. Select cables in accordance with local cable specifications (green-and-yellow cables are only used for PE).

5.1 Preparing for Installation

Figure 5-1 SUN2000 cable connections (optional in dashed boxes)

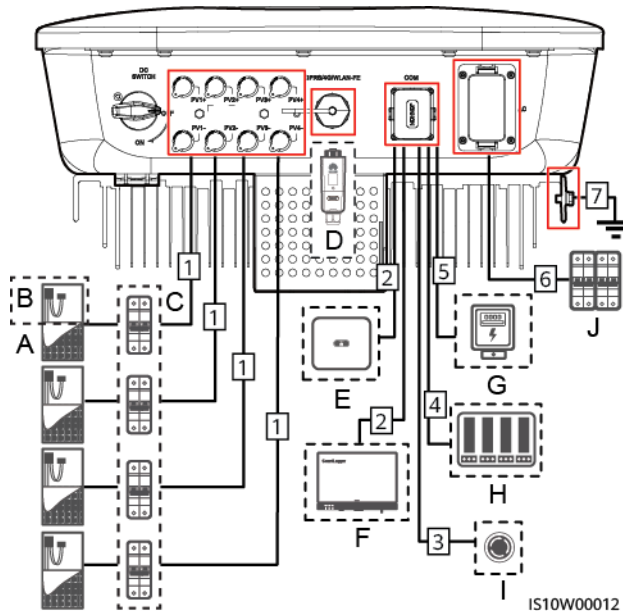

NOTICE

If the Smart Dongle is configured, you are advised to install the Smart Dongle before connecting the signal cable.

Table 5-1 Component description

No.	Component	Description	Source
A	PV module	<ul style="list-style-type: none"> A PV string is composed of the PV modules connected in series. The SUN2000 supports the input from four PV strings. 	Prepared by the customer
B	Smart PV optimizer	The SUN2000-450W-P smart PV optimizer is supported.	Purchased from Huawei
C	DC switch	Recommended: a PV circuit breaker with a rated voltage greater than or equal to 1100 V DC and a rated current of 15 A.	Prepared by the customer
D	Smart Dongle ^a	<ul style="list-style-type: none"> WLAN-FE Smart Dongle: SDongleA-05. 4G Smart Dongle: SDongleA-03. 	Purchased from Huawei

No.	Component	Description	Source
E	SUN2000	Select a proper model based on requirements.	Purchased from Huawei
F	SmartLogger	Select a proper model based on requirements.	Purchased from Huawei
G	Smart Power Sensor	The recommended electricity meter model is DTSU666-H.	Purchased from Huawei
H	Ripple Control Device	Select the devices that meet the power grid scheduling requirements.	Provided by local power grid companies
I	Rapid shutdown switch	Select a proper model based on requirements.	Prepared by the customer
J	AC switch ^b	Recommended: a three-phase AC circuit breaker with a rated voltage greater than or equal to 415 V AC and a rated current of: <ul style="list-style-type: none"> • 25 A (SUN2000-8KTL-M2, SUN2000-10KTL-M2, SUN2000-12KTL-M2) • 40 A (SUN2000-15KTL-M2, SUN2000-17KTL-M2, SUN2000-20KTL-M2) 	Prepared by the customer
<ul style="list-style-type: none"> • Note a: WLAN-FE Smart Dongle: For details about the SDongleA-05 operation, see <i>SDongleA-05 Quick Guide (WLAN-FE)</i>; 4G Smart Dongle: For details about the SDongleA-03 operation, see <i>SDongleA-03 Quick Guide (4G)</i>. You can obtain the quick guide at https://support.huawei.com/enterprise by searching for the Smart Dongle model. • Note b: SUN2000-8KTL-M2 and SUN2000-10KTL-M2 inverters are applicable only to Australia. 			

Table 5-2 Cable description

No.	Name	Type	Recommended Specifications
1	DC input power cable	Standard PV cable in the industry	<ul style="list-style-type: none"> • Conductor cross-sectional area: 4–6 mm² • Cable outer diameter: 5.5–9 mm
2	(Optional) RS485 communications cable (used to cascade inverters or connect to the RS485 signal port on the SmartLogger)	Two-core outdoor shielded twisted pair cable	<ul style="list-style-type: none"> • Conductor cross-sectional area: 0.2–1 mm² • Cable outer diameter: 4–11 mm

No.	Name	Type	Recommended Specifications
3	(Optional) RS485 communications cable (used to connect to the RS485 signal port on a Smart Power Sensor for export limitation)	Two-core outdoor shielded twisted pair cable	<ul style="list-style-type: none"> Conductor cross-sectional area: 0.2–1 mm² Cable outer diameter: 4–11 mm
4	(Optional) Rapid shutdown switch signal cable	Two-core outdoor shielded twisted pair cable	<ul style="list-style-type: none"> Conductor cross-sectional area: 0.2–1 mm² Cable outer diameter: 4–11 mm
5	(Optional) Grid scheduling signal cable	Five-core outdoor cable	<ul style="list-style-type: none"> Conductor cross-sectional area: 0.2–1 mm² Cable outer diameter: 4–11 mm
6	AC output power cable ^a	Outdoor copper cable ^b	SUN2000-8KTL-M2, SUN2000-10KTL-M2, SUN2000-12KTL-M2: <ul style="list-style-type: none"> Conductor cross-sectional area: 6–16 mm² Cable outer diameter: 11–26 mm
			SUN2000-15KTL-M2, SUN2000-17KTL-M2, SUN2000-20KTL-M2: <ul style="list-style-type: none"> Conductor cross-sectional area: 10–16 mm² Cable outer diameter: 11–26 mm
7	PE cable	Single-core outdoor copper cable ^c	SUN2000-8KTL-M2, SUN2000-10KTL-M2, SUN2000-12KTL-M2: Conductor cross-sectional area ≥ 6 mm ²
			SUN2000-15KTL-M2, SUN2000-17KTL-M2, SUN2000-20KTL-M2: Conductor cross-sectional area ≥ 10 mm ²
<ul style="list-style-type: none"> Note a: The minimum cable diameter depends on the fuse rating on the AC side. Note b: The SUN2000-8KTL-M2 and SUN2000-10KTL-M2 inverters are applicable only to Australia. Note c: The SUN2000-8KTL-M2 and SUN2000-10KTL-M2 inverters are applicable only to Australia. 			

 **NOTE**

- The minimum cable diameter should comply with the local cable standard.
- Factors influencing cable selection are as follows: nominal AC current, type of cable, routing method, ambient temperature, and maximum desired line losses.

5.2 Connecting the PE cable

Precautions

 **DANGER**

- Ensure that the PE cable is properly connected. If it is disconnected or loose, electric shocks may occur.
- Do not connect the neutral wire to the enclosure as a PE cable. Otherwise, electric shocks may occur.

 **NOTE**

- The PE point at the AC output port is used only as a PE equipotential point, and cannot substitute for the PE point on the enclosure.
- After the ground cable is installed, it is recommended that the silica gel or paint be applied to the ground terminal for protection.

Additional Information

The SUN2000 has the grounding detection function. This function detects whether the SUN2000 is grounded properly before its startup, or whether the ground cable is disconnected when the SUN2000 is running. This function works under limited conditions. To ensure the safe operation of the SUN2000, ground the SUN2000 properly according to the connection requirements of the PGND cable. For some power grid types, if the output side of the inverter is connected to an isolation transformer, ensure that the inverter is properly grounded and set **isolation settings** to **Input not grounded, with a transformer** to enable the inverter to run properly.

- According to IEC62109, to ensure safe application in case of the ground cable is damaged or disconnected, connect the PE cable properly before the grounding detection function is disabled. Ensure that the PE cable meets at least one of the following requirements.
 - If the PE terminal is not connected to the AC connector, use a single-core outdoor copper cable with a conductor cross-sectional area of at least 10 mm² as the PE cable on the chassis.
 - Use cables that have the same diameter as the AC output cable, and ground the PE terminal on the AC connector and the ground screw on the enclosure respectively.
- In some countries and regions, additional ground cables are required for the SUN2000. In this case, use cables that have the same diameter as the AC output cable, and ground the PE terminal on the AC connector and the ground screw on the enclosure respectively.

Procedure

Step 1 Crimp the OT terminal.

NOTICE

- Pay attention not to damage the core wire when stripping a cable.
- The cavity formed after crimping the conductor strip of the OT terminal needs to wrap the core wire completely. The core wire needs to contact the OT terminal closely.
- Wrap the wire crimping area with the heat shrink tubing or the PVC insulation tape. The following figure uses the heat shrink tubing as an example.
- When using the heat gun, protect devices from being scorched.

Figure 5-2 Crimping an OT terminal

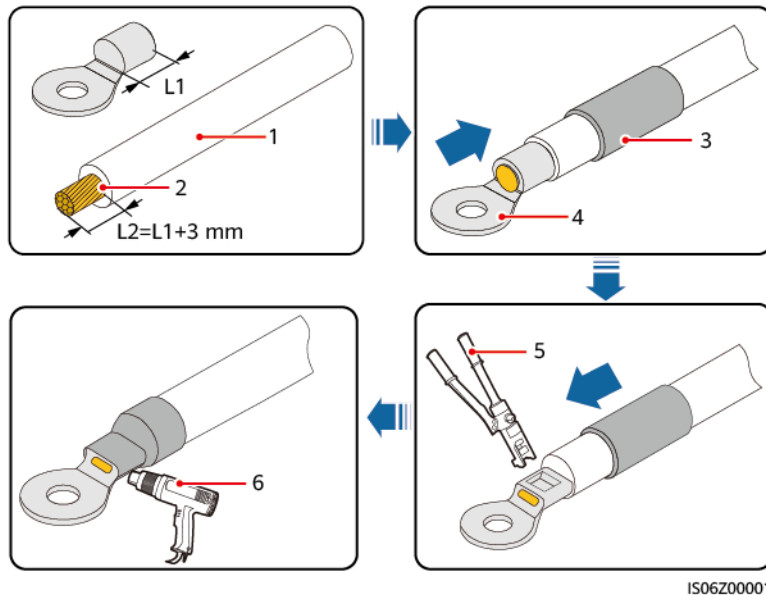

(1) Cable

(2) Core wire

(3) Heat shrink tubing

(4) OT terminal

(5) Crimping tool

(6) Heat gun

Step 2 Connect the PE cable.

Figure 5-3 Connecting the PE cable

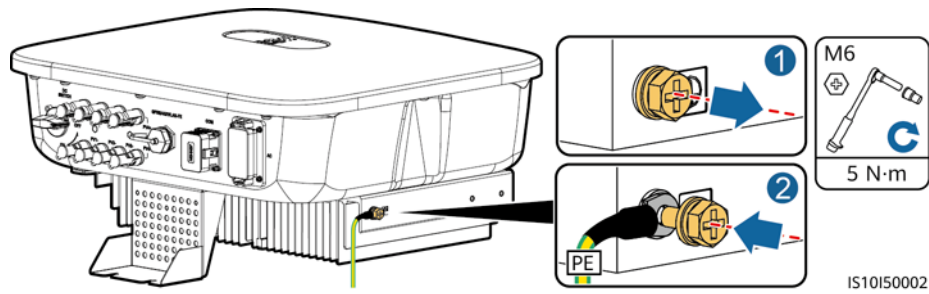

----End

5.3 Connecting the AC Output Power Cable

Precautions

A three-phase AC switch needs to be installed on the AC side of the SUN2000. To ensure that the SUN2000 can safely disconnect itself from the power grid when an exception occurs, select a proper overcurrent protection device in compliance with local power distribution regulations.

WARNING

Do not connect loads between the SUN2000 and the AC switch directly connected to it.

The SUN2000 is integrated with a comprehensive residual current monitoring unit. Once detecting that the residual current exceeds the threshold, the SUN2000 immediately disconnects itself from the power grid.

NOTICE

- If the external AC switch can perform earth leakage protection, the rated leakage action current should be greater than or equal to 300 mA.
 - If multiple SUN2000s connect to the general residual current device (RCD) through their respective external AC switches, the rated leakage action current of the general RCD should be greater than or equal to the number of SUN2000s multiplied by 300 mA.
 - A knife switch cannot be used as an AC switch.
 - The hex key is delivered with the inverter and bound to the hanging kit at the bottom of the inverter.
-

Figure 5-4 Hex key

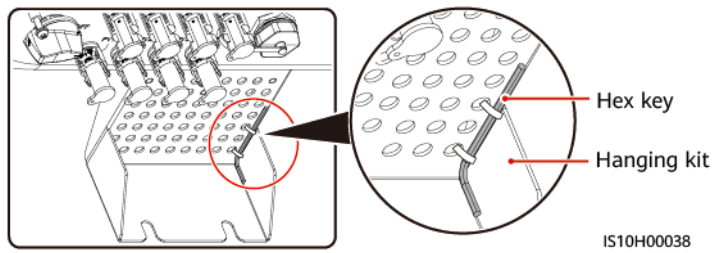

Procedure

Step 1 Connect the AC output power cable to the AC connector.

Figure 5-5 Stripping requirements

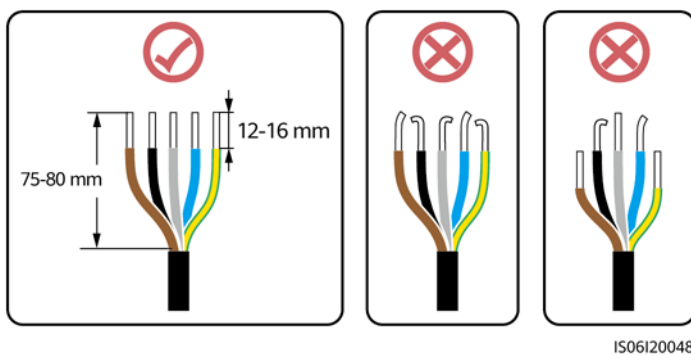

NOTICE

- Ensure that the cable jacket is inside the connector.
- Ensure that the exposed core wire is totally inserted into the cable hole.
- Ensure that AC terminations provide firm and solid electrical connections. Failing to do so may cause SUN2000 malfunction and damage to its AC connectors.
- Ensure that the cable is not twisted.

Figure 5-6 Three-core cable (L1, L2, and L3)

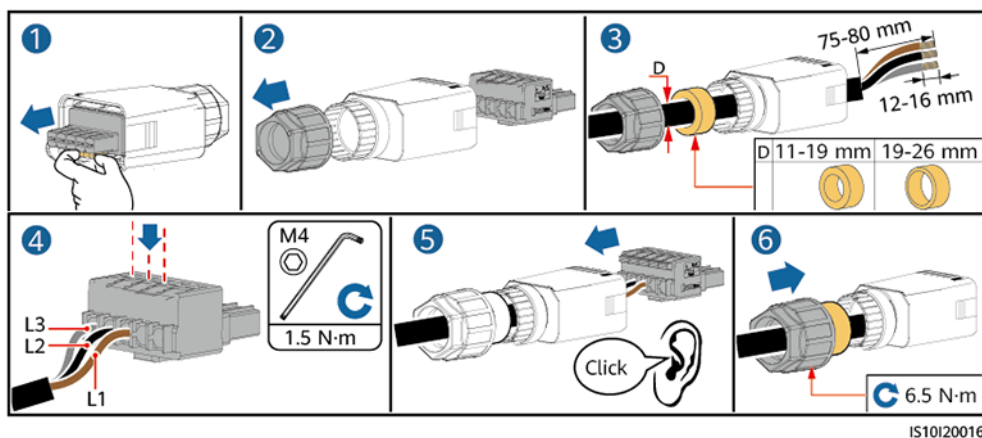

Figure 5-7 Four-core cable (L1, L2, L3, and PE)

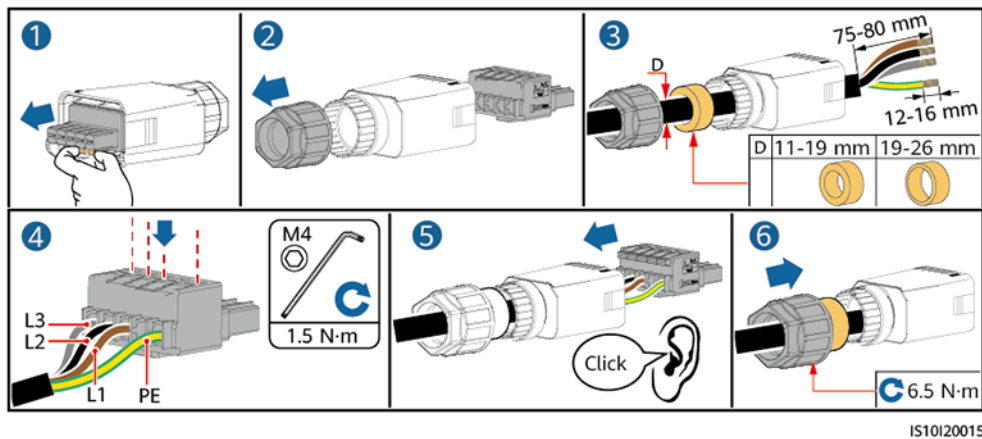

Figure 5-8 Four-core cable (L1, L2, L3, and N)

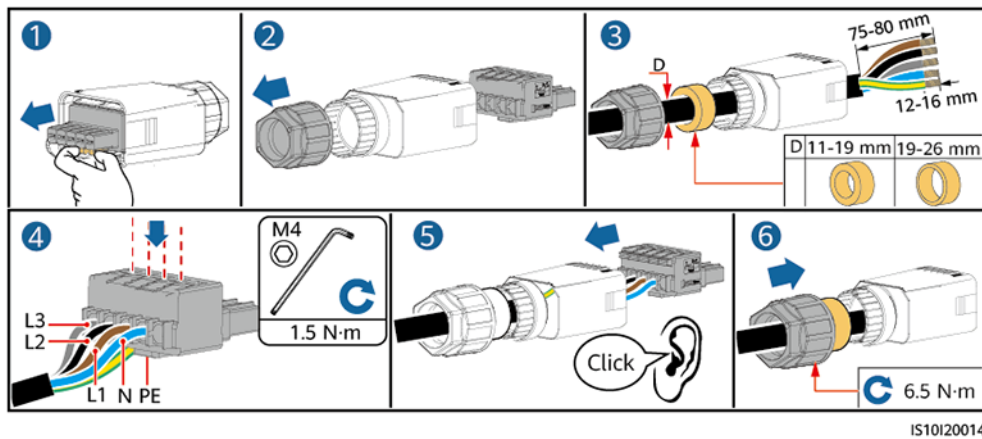
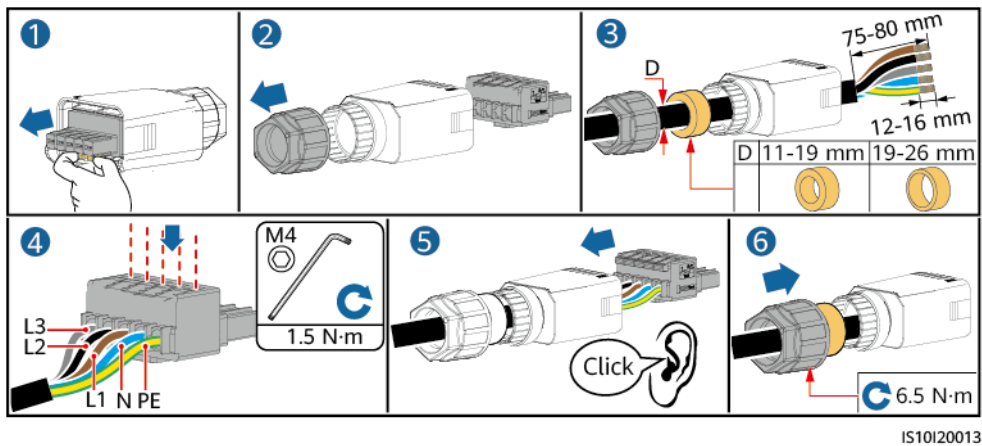

Figure 5-9 Five-core cable (L1, L2, L3, N, and PE)



NOTE

The cable colors shown in the figures are for reference only. Select an appropriate cable according to local standards.

Step 2 Connect the AC connector to the AC output port.

NOTICE

Ensure that the AC connector is connected securely.

Figure 5-10 Securing the AC connector

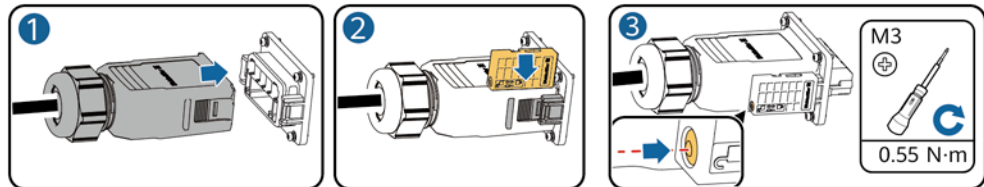

Step 3 Check the route of the AC output power cable.

Figure 5-11 Cable route

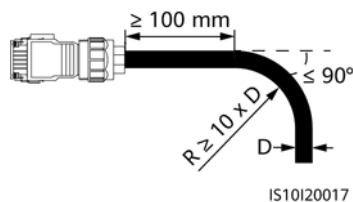

----End

Disconnection

Disconnection can be performed in reverse order.

5.4 Connecting the DC input power cable

Precautions

⚠ DANGER

- Before connecting the DC input power cable, ensure that the DC voltage is within the safe range (lower than 60 V DC), and that the **DC SWITCH** is set to the **OFF** position. Failure to do so could generate high voltage, which may cause electric shocks.
- When the SUN2000 is operating, it is not allowed to operate the DC input power cable, such as connecting or disconnecting a PV string or a PV module in a PV string. Failing to do so may cause electric shocks.
- If no PV string is connected to a DC input terminal of the SUN2000, do not remove the watertight cap from the terminal. Otherwise, the IP rating of the SUN2000 will be affected.

WARNING

Ensure that the following conditions are met. Otherwise, the SUN2000 may be damaged, or even a fire could happen.

- PV modules connected in series in each PV string are of the same specifications.
- The open-circuit voltage of each PV string is always lower than or equal to 1080 V DC.
- The maximum short-circuit current of each PV string must be lower than or equal to 15 A.
- The DC input power cable is correctly connected. The positive and negative terminals of a PV module are connected to corresponding positive and negative DC input terminals of the SUN2000.
- If the DC input power cable is reversely connected, do not operate the DC switch and positive and negative connectors. Wait until the solar irradiance declines at night and the PV string current reduces to below 0.5 A, and then turn off the DC switch. Remove the positive and negative connectors to correct the polarity.

NOTICE

- Because the output of the PV string connected to the SUN2000 cannot be grounded, ensure that the PV module output is insulated to ground.
- The PV strings connecting to the same MPPT route should contain the same number and model of PV modules or Smart PV optimizers.
- During the installation of PV strings and the SUN2000, the positive or negative terminals of PV strings may be short-circuited to ground if power cables are not properly installed or routed. An AC or DC short circuit may occur and damage the device when the SUN2000 is operating. The caused device damage is not covered under any warranty.

Terminal Description

Figure 5-12 Terminals

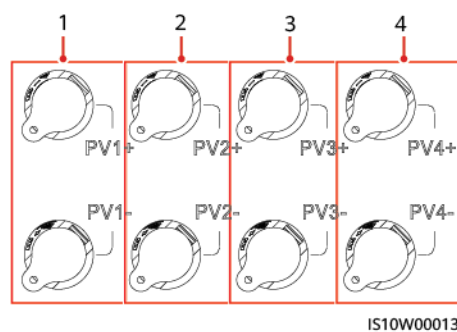

(1) Terminals of DC input 1

(2) Terminals of DC input 2

(3) Terminals of DC input 3

(4) Terminals of DC input 4

Procedure

WARNING

Before inserting the positive and negative connectors into the positive and negative DC input terminals of the SUN2000, check that the **DC SWITCH** is **OFF**.

NOTICE

- Cables with high rigidity, such as armored cables, are not recommended as DC input power cables, because poor contact may be caused by the bending of the cables.
 - Before assembling DC connectors, label the cable polarities correctly to ensure correct cable connections.
 - After crimping the positive and negative metal contacts, pull the DC input power cables back to ensure that they are connected securely.
 - Insert the crimped metal contacts of the positive and negative power cables into the appropriate positive and negative connectors. Then pull back the DC input power cables to ensure that they are connected securely.
 - If the DC input power cable is reversely connected and the **DC SWITCH** is set to the **ON** position, do not operate the **DC SWITCH** and positive and negative connectors. Otherwise, the device may be damaged. The caused device damage is not covered under any warranty. Wait until the solar irradiance declines and the PV string current drops to below 0.5 A. Then set the two **DC SWITCH** to the **OFF** position, remove the positive and negative connectors, and rectify the connection of the DC input power cable.
-

NOTE

- The DC voltage measurement range of the multimeter must be at least 1080 V. If the voltage is a negative value, the DC input polarity is incorrect and needs correction. If the voltage is greater than 1080 V, too many PV modules configured in the same string. Remove some PV modules.
- If the PV string is configured with an optimizer, check the cable polarity by referring to the Smart PV optimizer quick guide.

Step 1 Connect the DC input power cable.

CAUTION

Use the Staubli MC4 positive and negative metal terminals and DC connectors delivered with the SUN2000. Using incompatible positive and negative metal terminals and DC connectors may result in serious consequences. The caused device damage is not covered under any warranty or service agreement.

Figure 5-13 Assembling a DC connector

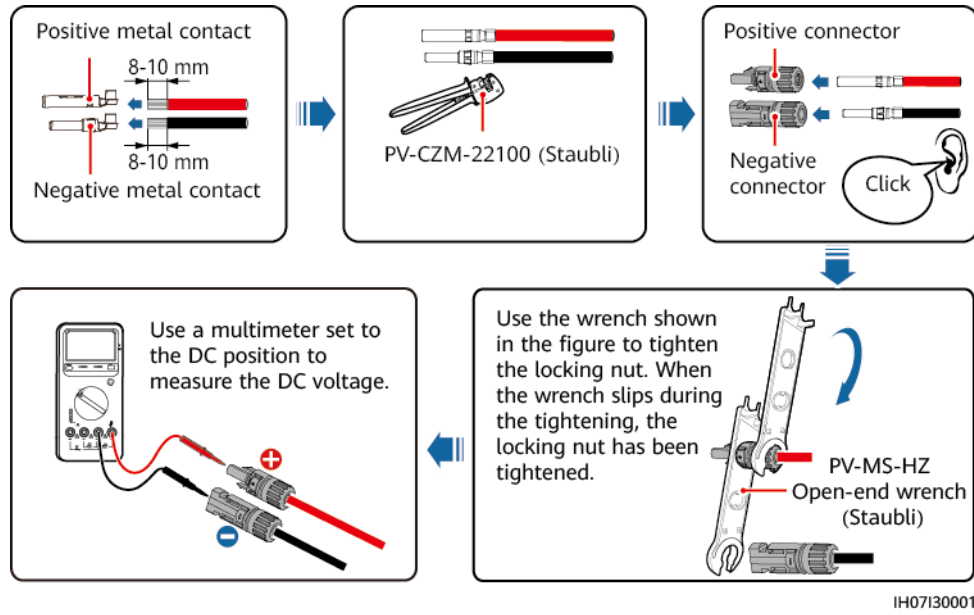

----End

Removing a DC connector



Before removing the positive and negative connectors, ensure that the **DC SWITCH** is **OFF**.

To remove the positive and negative connectors from the SUN2000, insert an open-end wrench into the notch and press hard to remove the DC connector.

Figure 5-14 Removing a DC connector

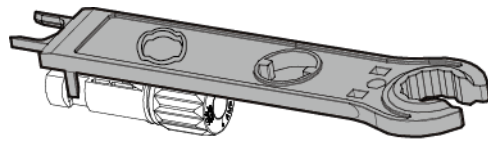

IH07H00019

5.5 (Optional) Installing the Smart Dongle

Procedure

 NOTE

- If WLAN-FE communication is used, install a WLAN-FE Smart Dongle (SDongleA-05).
- If 4G communication is used, install a 4G Smart Dongle (SDongleA-03).
- You need to purchase the Smart Dongle by yourself.

- WLAN-FE Smart Dongle (FE Communication)

You are advised to use a CAT 5E outdoor shielded network cable (outer diameter < 9 mm; internal resistance ≤ 1.5 ohms/10 m) and shielded RJ45 connectors.

Figure 5-15 Installing a WLAN-FE Smart Dongle (FE communication)

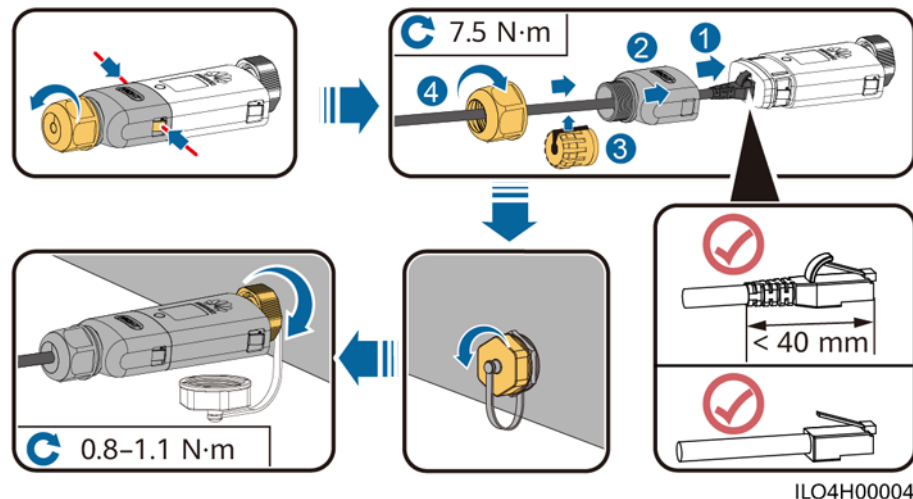

- 4G Smart Dongle (4G Communication)

 NOTE

- If you prepared a Smart Dongle without a SIM card, you need to prepare a standard SIM card (size: 25 mm x 15 mm) with the capacity greater than or equal to 64 KB.
- When installing the SIM card, determine its installation direction based on the silk screen and arrow on the card slot.
- When being pressed into place, the SIM card will be locked, which means that the card is installed correctly.
- To remove the SIM card, push it inwards. Then the SIM card springs out automatically.
- When reinstalling the WLAN-FE Smart Dongle or 4G Smart Dongle, ensure that the buckle springs back in place.

Figure 5-16 Installing the 4G Smart Dongle

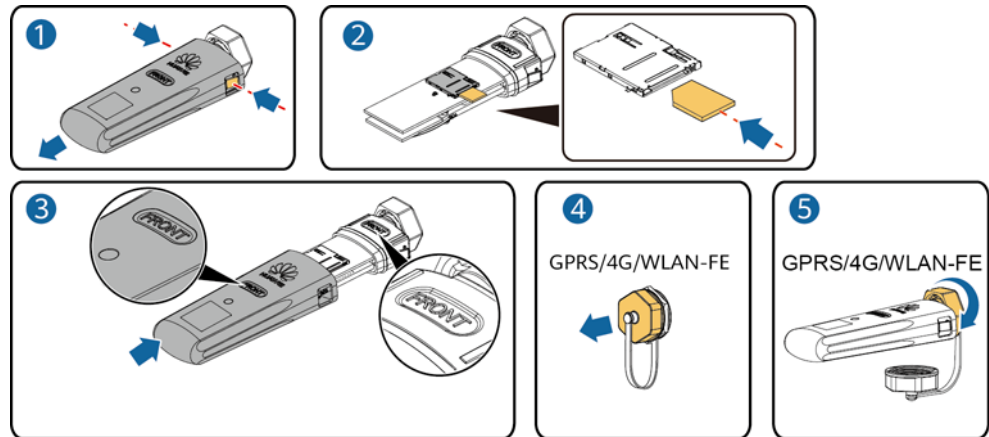

 NOTE

There are two types of Smart Dongle:

- For details about how to use the WLAN-FE Smart Dongle SDongleA-05, see the [SDongleA-05 Quick Guide \(WLAN-FE\)](#). You can also scan the QR code to obtain the document.



- For details about how to use the 4G Smart Dongle SDongleA-03, see the [SDongleA-03 Quick Guide \(4G\)](#). You can also scan the QR code to obtain the document.



The quick guide is delivered with the Smart Dongle.

5.6 (Optional) Installing the Signal Cable

Communication port signal definitions

NOTICE

- Not all inverter models are delivered with the signal cable connector.
- When routing the signal cable, ensure that it is separate from the power cable and away from interfering sources to prevent communication from being affected.
- The protection layer of the cable is in the connector. Cut off surplus core wires from the protection layer. Ensure that the core wires are completely inserted into the cable holes, and that the cable is securely connected.
- If the Smart Dongle is configured, you are advised to install the Smart Dongle before connecting the signal cable.

Figure 5-17 Signal definitions

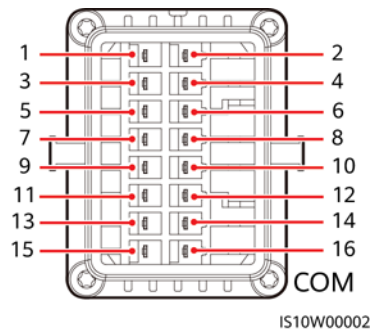

Table 5-3 Signal definitions

Pin	Definition	Function	Description	Pin	Definition	Function	Description
1	485A1-1	RS485 differential signal+	Used to connect to the RS485 signal port on the SUN2000 or SmartLogger1000	2	485A1-2	RS485 differential signal+	Used to connect to the RS485 signal port on the SUN2000 or SmartLogger1000A
3	485B1-1	RS485 differential signal-		4	485B1-2	RS485 differential signal-	
5	PE	Shielding ground	N/A	6	PE	Shielding ground	N/A
7	485A2	RS485 differential signal+	Used to connect to an RS485 signal port on a Smart Power Sensor for export limitation	8	DIN1	Dry contact interface for grid scheduling	N/A
9	485B2	RS485 differential signal-		10	DIN2		
11	N/A	N/A	N/A	12	DIN3		

Pin	Definition	Function	Description	Pin	Definition	Function	Description
13	GND	GND	Used to connect to the rapid shutdown DI signal port or serve as a port for the signal cable of the NS protection.	14	DIN4		
15	DIN5	Rapid shutdown signal+		16	GND		

Communication Networking

- Smart Dongle Networking Scenario

Figure 5-18 Smart Dongle networking

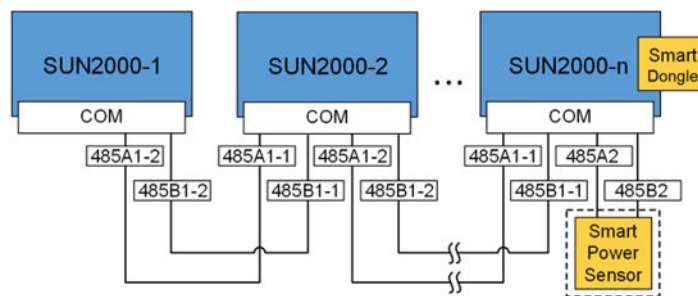

NOTE

- In the Smart Dongle networking scenario, the SmartLogger cannot be connected.
- The Smart Power Sensor is necessary for export limitation. Only the DTSU666-H Smart Power Sensor (provided by Huawei) can be used.
- The Smart Power Sensor and Smart Dongle need to be connected to the same inverter.
- SmartLogger Networking Scenario

Figure 5-19 SmartLogger networking

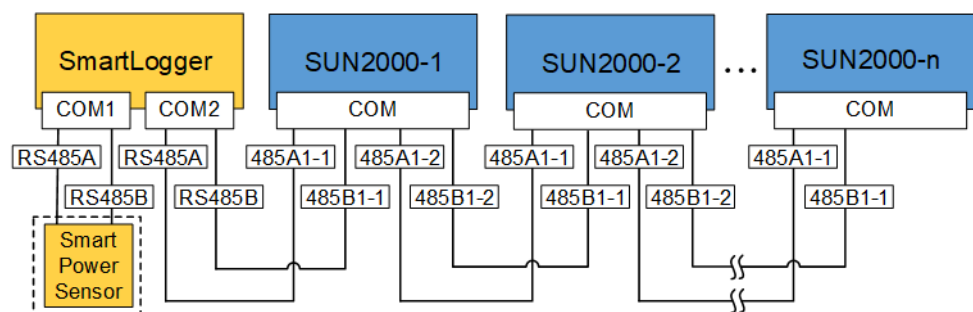

NOTE

- In the SmartLogger networking scenario, the Smart Dongle cannot be connected.
- A maximum of 80 devices can connect to a single SmartLogger, such as inverters, Smart Power sensor, and EMI. You are advised to connect fewer than 30 devices to each RS485 route.
- The Smart Power Sensor is necessary for export limitation. Select the Smart Power Sensor according to the actual project.
- To ensure the system response speed, the Smart Power Sensor is recommended to be connected to a COM port separately from inverter COM port.

5.6.1 Connecting the RS485 Communications Cable (Inverter Cascading)

Procedure

Step 1 Connect the signal cable to the signal cable connector.

Figure 5-20 Installing the cable

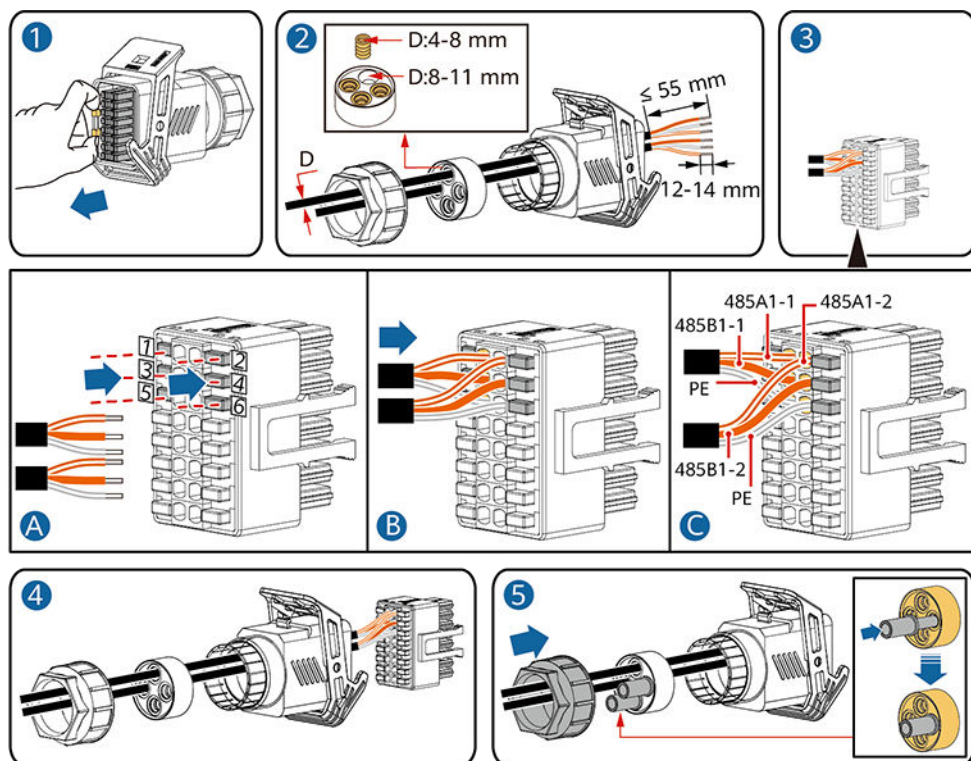

IS10120006

Step 2 Connect the signal cable connector to the COM port.

Figure 5-21 Securing the signal cable connector

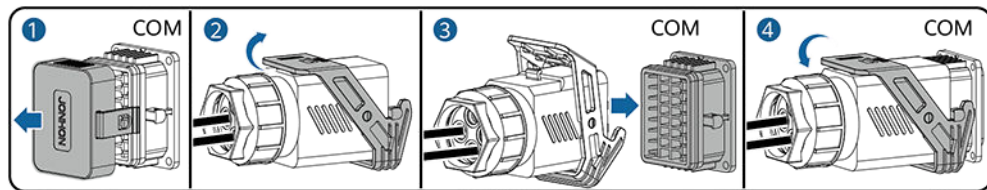

IS10120007

----End

5.6.2 Connecting the RS485 Communications Cable (Smart Power Sensor)

Cable Connection

The following figure shows the cable connections between the inverter and the Smart Power Sensor.

Figure 5-22 Cable connection (Three Phase Three Wire)

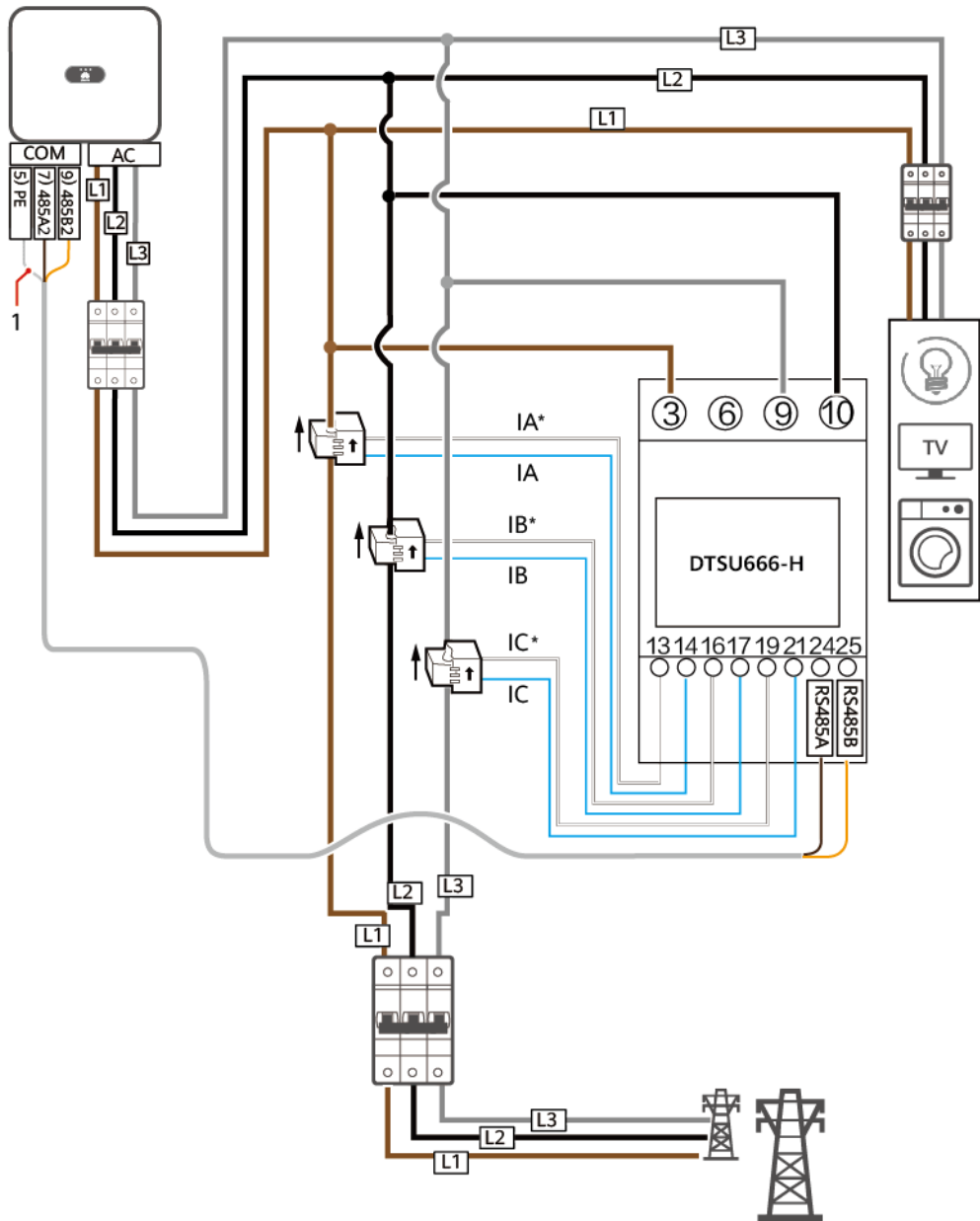

IH05N00005

Figure 5-23 Cable connection (Three Phase Four Wire)

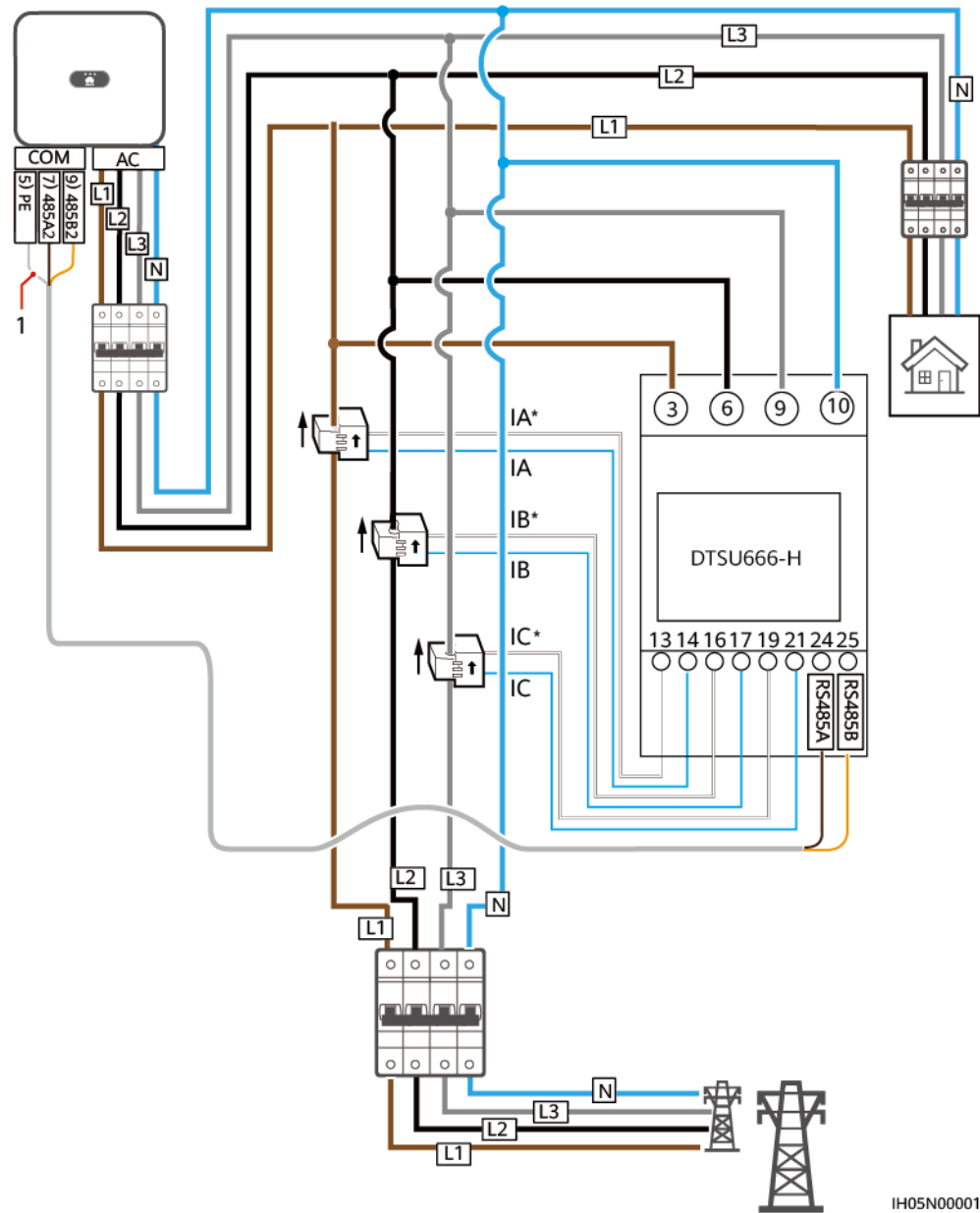

(1) Shielding layer of the signal cable

NOTE

For a three-phase three-wire system, you need to set the cable connection mode. Otherwise, the displayed voltage is incorrect.

Table 5-4

Parameter	Note
nEt	Select the cable connection mode: 0: n.34 indicates three-phase four-wire. 1: n.33 indicates three-phase three-wire.

Procedure

Step 1 Connect the signal cable to the signal cable connector.

Figure 5-24 Installing the cable

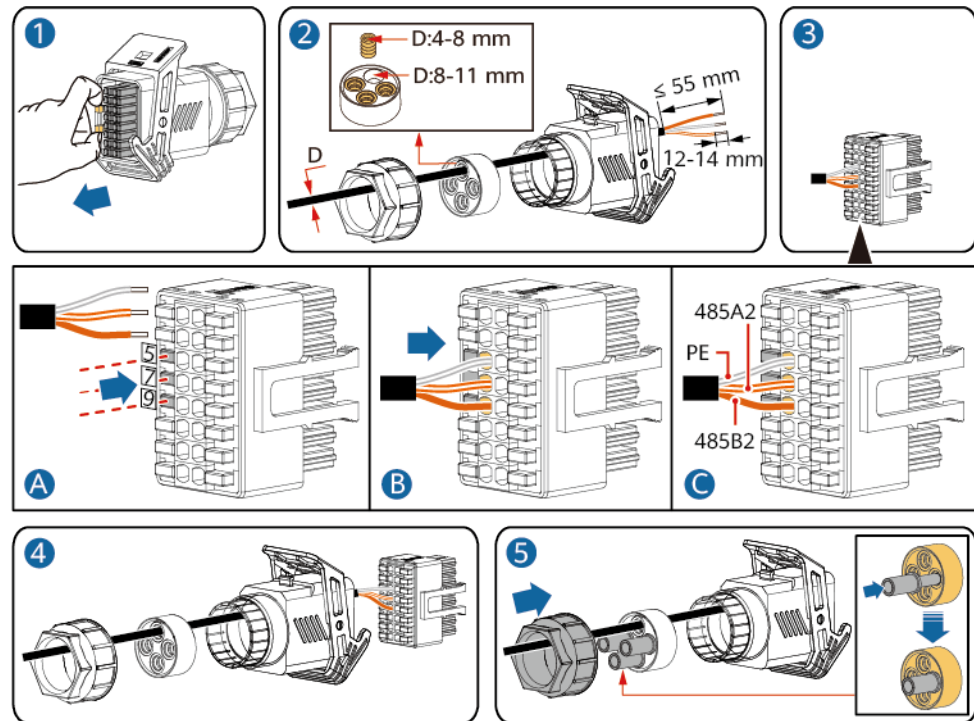

IS10I20008

Step 2 Connect the signal cable to the COM port.

Figure 5-25 Securing the signal cable connector

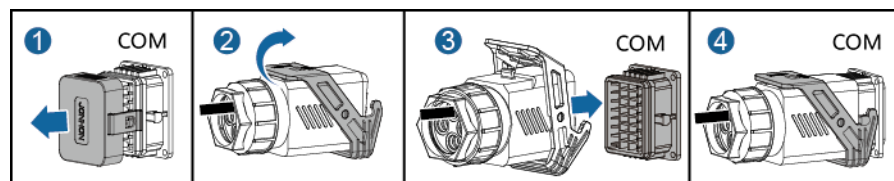

IS10I20007

----End

5.6.3 Connecting the Rapid shutdown signal cable

Procedure

Step 1 Connect the signal cable to the signal cable connector.

NOTICE

- If optimizers are configured for some PV modules, the rapid shutdown function is not supported.
- To enable the rapid shutdown function, you need to connect the access switch to pins 13 and 15. The switch is closed by default. The rapid shutdown is triggered when the switch changes from closed to open.

Figure 5-26 Installing the cable

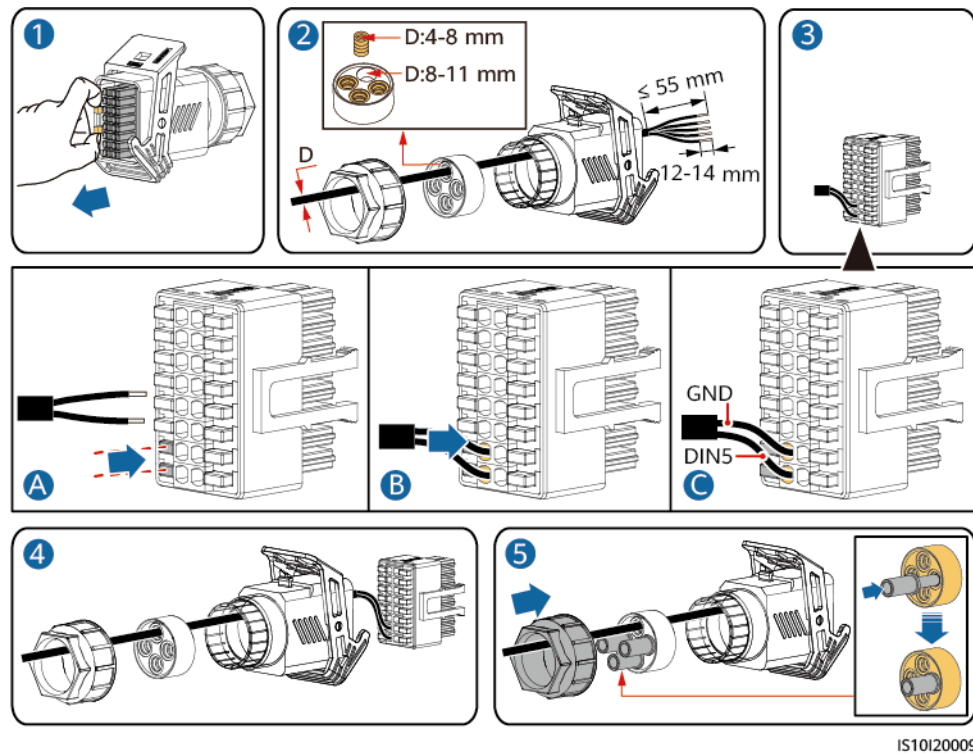

Step 2 Connect the signal cable connector to the COM port.

Figure 5-27 Securing the signal cable connector

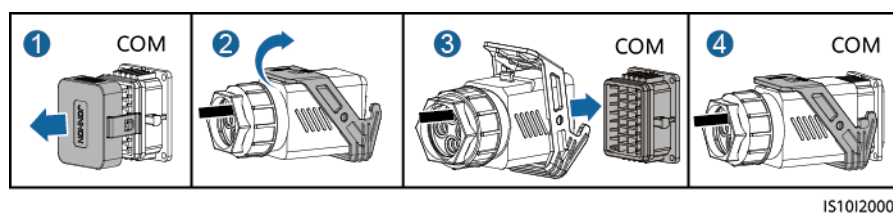

----End

5.6.4 Connecting the Power Grid Scheduling Signal Cable

Cable Connection

The following figure shows the cable connections between the inverter and the Ripple Control Device.

Figure 5-28 Cable connection

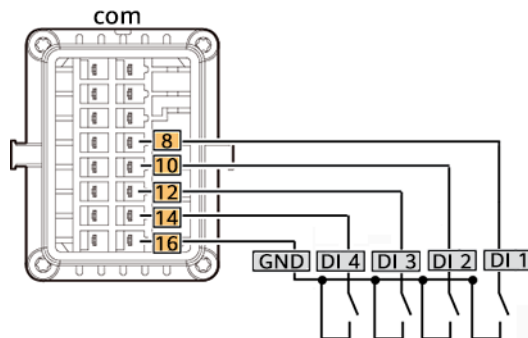

Procedure

Step 1 Connect the signal cable to the signal cable connector.

Figure 5-29 Installing the cable

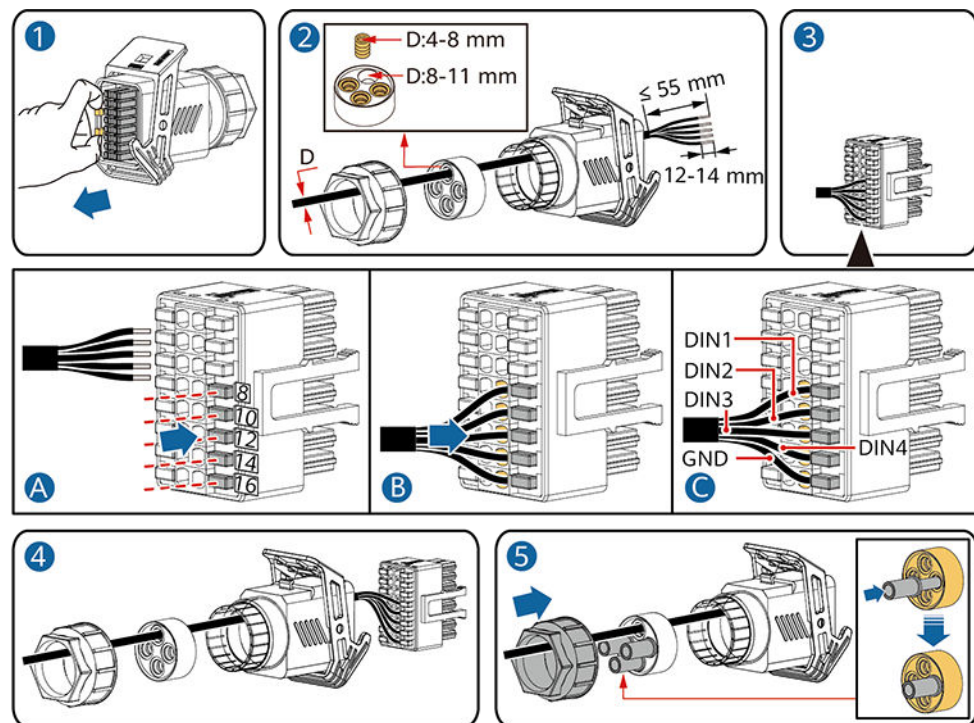

Step 2 Connect the signal cable to the COM port.

Figure 5-30 Securing the signal cable connector

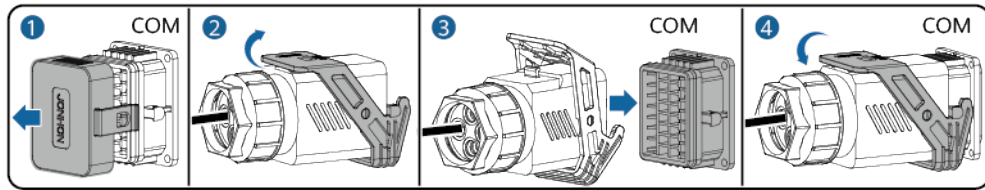

IS10I20007

----End

5.6.5 Connecting the NS Protection Signal Cable

Connecting the Inverter to the NS Protection Signal Cable

NOTE

- The NS protection function applies to areas in compliance with the VDE4105 standard, and the grid code needs to be set to **VDE-AR-N-4105**.
- The NS protection switch is connected to GND (pin 13) at one end and to DIN5 (pin 15) at the other end. The switch is turned off by default. When the switch is turned on, NS protection is triggered. Rapid shutdown and NS protection use the same pins, which are GND (pin 13) and DIN5 (pin 15). Therefore, you can use only one of the functions.
- The NS protection switch connection is the same for a single inverter and for cascaded inverters.
- Log in to the FusionSolar app as an installer, choose **My > Device Commissioning**, and connect to the WLAN hotspot of the SUN2000. Log in to the local commissioning system as an installer user, choose **Settings > Feature parameters > Dry contact function**, and set **Dry contact function** to **NS protection**.

Figure 5-31 Connecting cascaded inverters to the NS protection switch

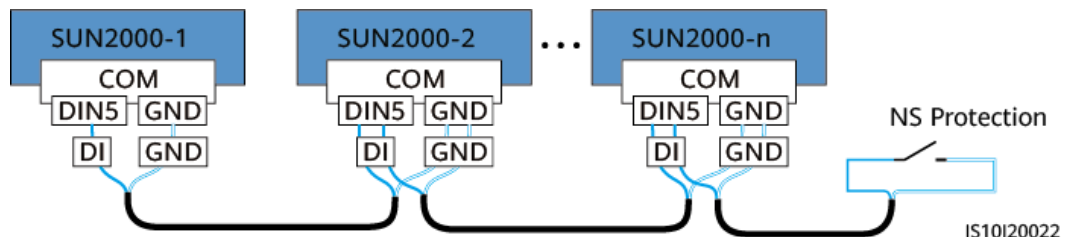

IS10I20022

Step 1 Connect the signal cables of the cascaded inverters to the signal cable connectors.

Figure 5-32 Installing cables

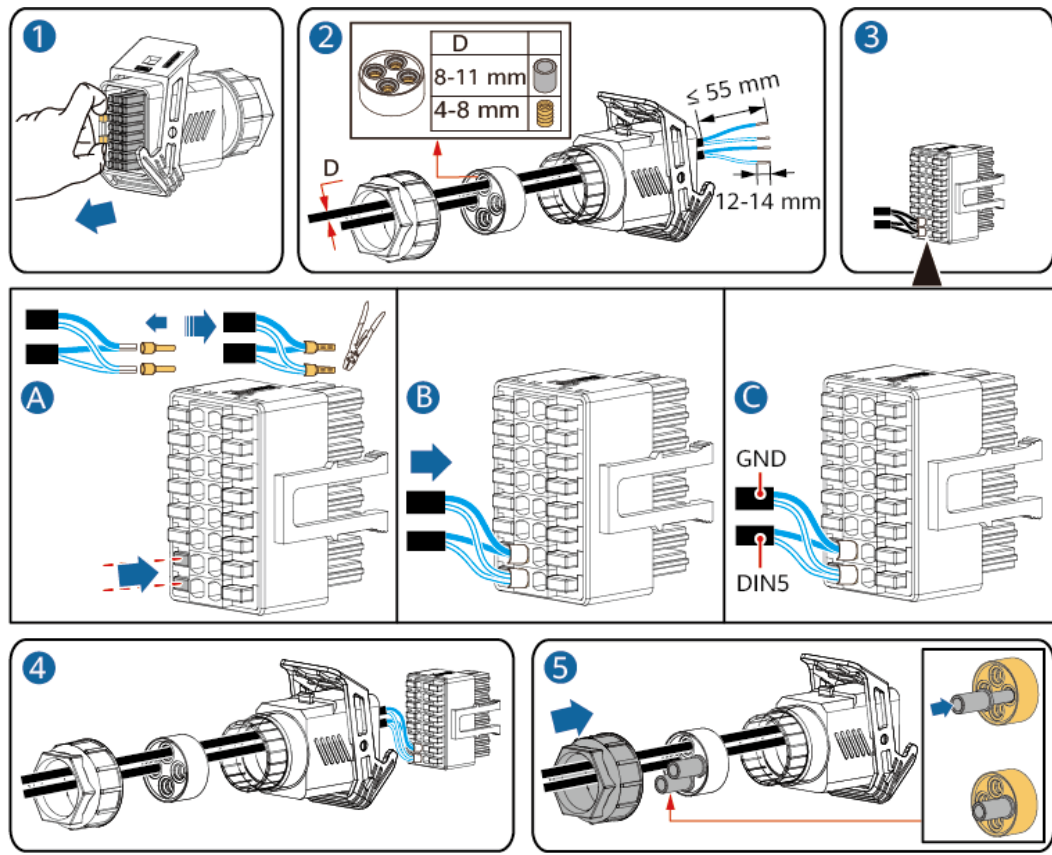

IS10I20021

Step 2 Connect the signal cable connectors to the COM ports.

Figure 5-33 Securing the signal cable connector

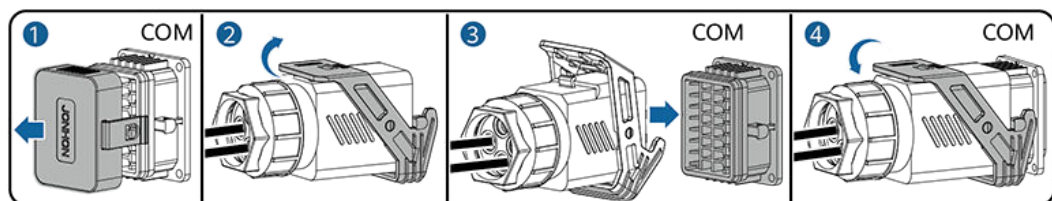

IS10I20007

----End

Setting NS Protection Remote Shutdown

NOTE

- The NS protection function is applicable to areas in compliance with the VDE4105 standard. To configure this function, choose **Monitoring > Running Param. > Grid Parameters** and set **Grid code** to **VDE-AR-N-4105**.
- The NS protection device is connected to the AI1 port and 12V power output port. The SmartLogger shuts down the inverter over the voltage change detected at the AI1 port. When the NS protection device is disconnected, the AI1 port voltage is 0 V, and the inverter shuts down. When the NS protection device is connected again, the AI1 port voltage is 12 V, and you need to start the inverter manually.

Figure 5-34 Connecting the SmartLogger to the NS protection switch

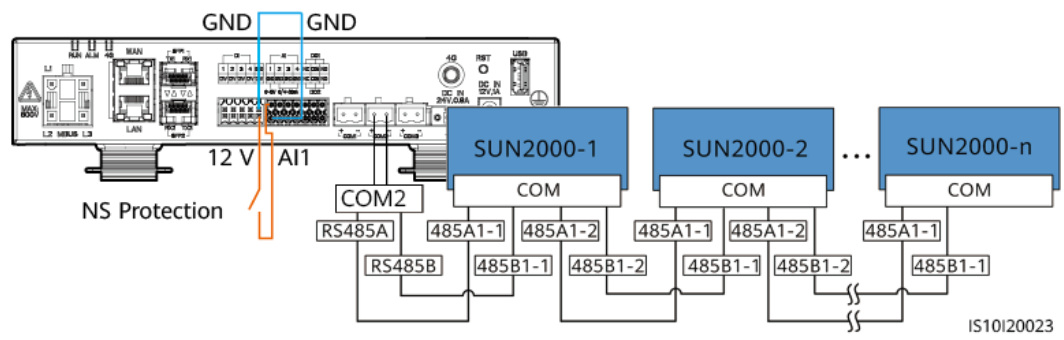

6 Commissioning

6.1 Check Before Power-On

Table 6-1 Installation checklist

No.	Check Item	Acceptance Criteria
1	SUN2000 installation	The SUN2000 is installed correctly, securely, and reliably.
2	Smart Dongle	The Smart Dongle is installed correctly and securely.
3	Cable layout	Cables are routed properly as required by the customer.
4	Cable tie	Cable ties are secured evenly and no burr exists.
5	Grounding	The ground cable is connected correctly, securely, and reliably.
6	Turn off the switches	The DC SWITCH and all the switches connected to the SUN2000 are set to OFF .
7	Cable connections	The AC output power cable, DC input power cable, and signal cable are connected correctly, securely, and reliably.
8	Unused terminals and ports	Unused terminals and ports are locked by watertight caps.
9	Installation environment	The installation space is proper, and the installation environment is clean and tidy, without foreign matter.

6.2 Powering On the System

Precautions

NOTICE

- Before turning on the AC switch between the SUN2000 and the power grid, use a multimeter set to the AC position to check that the AC voltage is within the specified range.
- If the DC is on and the AC is off, the SUN2000 reports a **Grid Failure** alarm. The SUN2000 starts normally only after the fault is automatically rectified.

Procedure

- Step 1** Turn on the AC switch between the SUN2000 and the power grid.
- Step 2** (Optional) Remove the locking screw from the DC switch.

Figure 6-1 Removing the locking screw from a DC switch

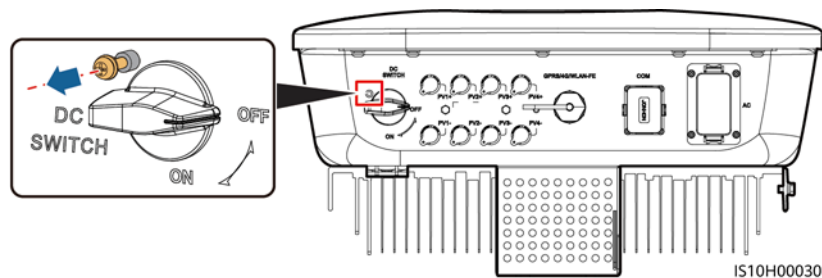

- Step 3** If there is a DC switch between the PV string and the inverter, turn on the DC switch.
- Step 4** Set the **DC SWITCH** at the bottom of the SUN2000 to the **ON** position.
- Step 5** Wait for about 1 minute, and then observe the LED indicators of the inverter to check the running status.

Table 6-2 LED indicator description

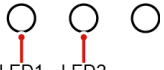
Category	Status		Meaning
Running indication   LED1 LED2	LED1	LED2	N/A
	Steady green	Steady green	The SUN2000 is operating in grid-tied mode.

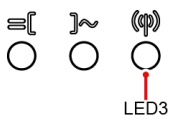
Category	Status			Meaning
	Blinking green at long intervals (on for 1s and then off for 1s)	Off		The DC is on and the AC is off.
	Blinking green at long intervals (on for 1s and then off for 1s)	Blinking green at long intervals (on for 1s and then off for 1s)		The DC is on, the AC is on, and the SUN2000 is not exporting power to the power grid.
	Off	Blinking green at long intervals (on for 1s and then off for 1s)		The DC is off and the AC is on.
	Off	Off		Both the DC and AC are off.
	Blinking red at short intervals (on for 0.2s and then off for 0.2s)	N/A		There is a DC environmental alarm, such as an alarm indicating that High String Input Voltage, String Reverse Connection, or Low Insulation Resistance.
	N/A	Blinking red at short intervals (on for 0.2s and then off for 0.2s)		There is an AC environmental alarm, such as an alarm indicating Grid Undervoltage, Grid Overvoltage, Grid Overfrequency, or Grid Underfrequency.
	Steady red	Steady red		Fault
Communication indication 	LED3			N/A
	Blinking green at short intervals (on for 0.2s and then off for 0.2s)			Communication is in progress. (When a mobile phone is connected to the SUN2000, the indicator first indicates that the phone is connected to the SUN2000): blinks green at long intervals.)
	Blinking green at long intervals (on for 1s and then off for 1s)			The mobile phone is connected to the SUN2000.
	Off			There is no communication.
Device replacement indication	LED1	LED2	LED3	N/A
	Steady red	Steady red	Steady red	The SUN2000 hardware is faulty. The SUN2000 needs to be replaced.

- Step 6** (Optional) Observe the LED to check the operating status of the Smart Dongle.
- WLAN-FE Smart Dongle

Figure 6-2 WLAN-FE Smart Dongle

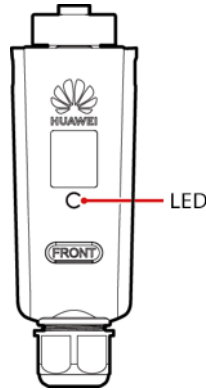

Table 6-3 LED indicator description

LED Color	Status	Remarks	Description
N/A	Off	Normal	The Dongle is not secured or is not powered on.
Yellow (blinking green and red simultaneously)	Steady on		The Dongle is secured and powered on.
Red	Blinking at short intervals (on for 0.2s and then off for 0.2s)		The parameters for connecting to the router are to be set.
	Steady on	Abnormal	The Dongle is faulty. Replace the Dongle.
Green	Blinking at long intervals (on for 0.5s and then off for 0.5s)	Normal	Connecting to the router.
	Steady on		Successfully connected to the management system.
	Blinking at short intervals (on for 0.2s and then off for 0.2s)		The inverter is communicating with the management system through the Dongle.

- 4G Smart Dongle

Table 6-4 LED indicator description

LED Color	Status	Remarks	Description
N/A	Off	Normal	The Dongle is not secured or is not powered on.
Yellow (blinking green and red simultaneously)	Steady on	Normal	The Dongle is secured and powered on.
Green	Blinking in a 2-second cycle (on for 0.1s and then off for 1.9s)	Normal	Dialing (duration < 1 min).
		Abnormal	If the duration is longer than 1 min, the 4G parameter settings are incorrect. Reset the parameters.
	Blinking at long intervals (on for 1s and then off for 1s)	Normal	The dial-up connection is set up successfully (duration < 30s).
		Abnormal	If the duration is longer than 30s, the settings of the management system parameters are incorrect. Reset the parameters.
	Steady on	Normal	Successfully connected to the management system.
	Blinking at short intervals (on for 0.2s and then off for 0.2s)		The inverter is communicating with the management system through the Dongle.
Red	Steady on	Abnormal	The Dongle is faulty. Replace Dongle.
	Blinking at short intervals (on for 0.2s and then off for 0.2s)		The Dongle has no SIM card or the SIM card is in poor contact. Check whether the SIM card has been installed or is in good contact. If not, install the SIM card or remove and insert the SIM card.

LED Color	Status	Remarks	Description
	Blinking at long intervals (on for 1s and then off for 1s)		The Dongle fails to connect to the management system because it has no signals, weak signal, or no traffic. If the Dongle is reliably connected, check the SIM card signal through the APP. If no signal is received or the signal strength is weak, contact the carrier. Check whether the tariff and traffic of the SIM card are normal. If not, recharge the SIM card or buy traffic.
Blinking red and green alternatively	Blinking at long intervals (on for 1s and then off for 1s)		No communication with the inverter. <ul style="list-style-type: none"> - Remove and insert the Dongle. - Check whether inverters match the Dongle. - Connect the Dongle to other inverters. Check whether the Dongle or the USB port of the inverter is faulty.

----End

7 Man-Machine Interaction

7.1 App Commissioning

7.1.1 Downloading the FusionSolar App

- Method 1: Access <https://solar.huawei.com> using the mobile phone browser and download the latest installation package.

Figure 7-1 Download Mode

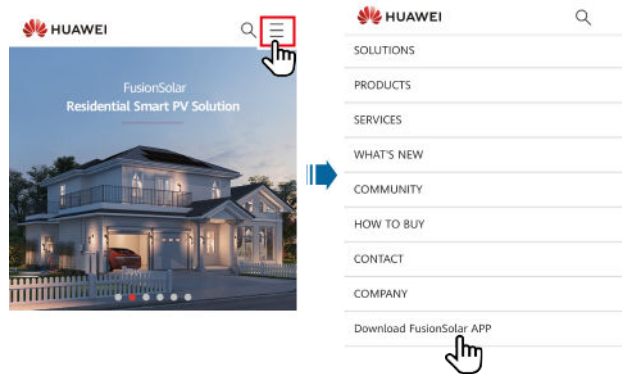

- Method 2: Search for FusionSolar on Huawei AppGallery and download the latest installation package.
- Method 3: Scan the following QR code and download the latest installation package.

Figure 7-2 QR code



7.1.2 (Optional) Registering an Installer Account

NOTE

- If you have an installer account, skip this step.
- You can register an account only using a mobile phone only in China.
- The mobile number or email address used for registration is the user name for logging in to the FusionSolar app.

Create the first installer account and create a domain named after the company name.

Figure 7-3 Creating the first installer account

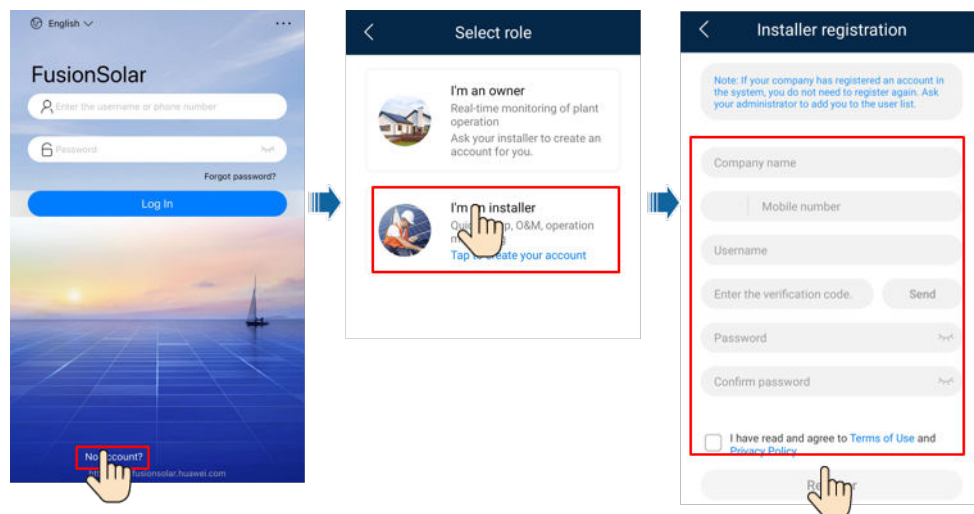

NOTICE

To create multiple installer accounts for a company, log in to the FusionSolar app and tap **Add User** to create an installer account.

Figure 7-4 Creating multiple installer accounts for the same company

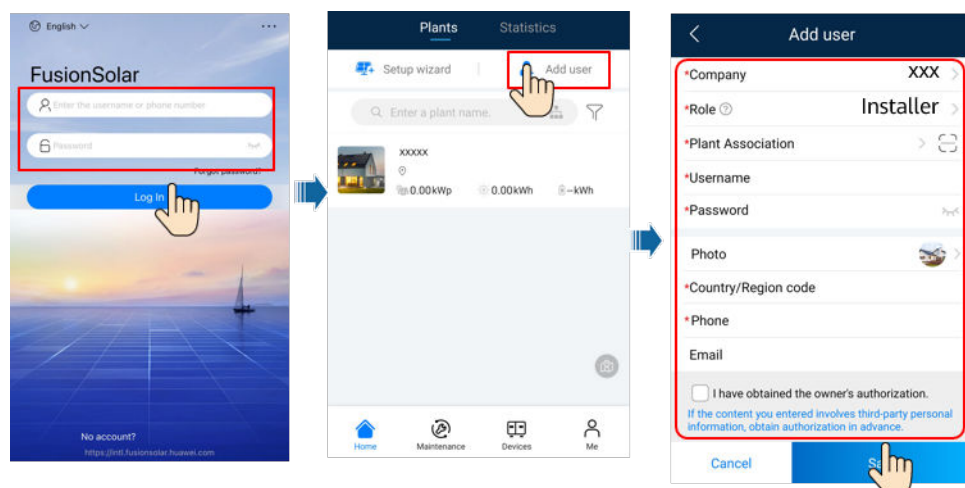

7.1.3 Creating a PV Plant and a User

Figure 7-5 Creating a PV plant and a user

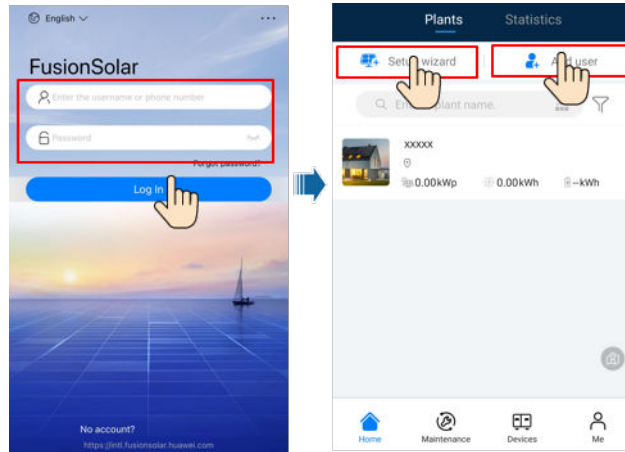

NOTE

- In the quick settings, the grid code is set to N/A by default (automatic startup is not supported). Set the grid code based on the area where the PV plant is located.
- For details about how to use the site deployment wizard, see [FusionSolar App Quick Guide](#). You can scan the QR code to download the quick guide.



7.1.4 (Optional) Setting the Physical Layout of the Smart PV Optimizers

NOTE

- If smart PV optimizers are configured for PV strings, ensure that the smart PV optimizers have been successfully connected to the SUN2000 before performing the operations in this section.
- Check that the SN labels of smart PV optimizers are correctly attached to the physical layout template.
- Take and save a photo of the physical layout template. Keep your phone parallel to the template and take a photo in landscape mode. Ensure that the four positioning points in the corners are in the frame. Ensure that each QR code is attached within the frame.
- For details about the physical layout of smart PV optimizers, see [FusionSolar App Quick Guide](#). You can scan the QR code to download the quick guide.



Scenario 1: Setting on the FusionSolar Server Side (Solar Inverter Connected to the Management System)

Step 1 Log in to the FusionSolar app and tap the plant name on the **Home** screen to access the plant screen. Select **Layout**, tap , and upload the physical layout template photo as prompted.

Figure 7-6 Uploading the physical layout template photo (App)



NOTE

You can also upload the physical layout template photo on the WebUI as follows: Log in to <https://intl.fusionsolar.huawei.com> to access the WebUI of the FusionSolar Smart PV Management System. On the **Home** page, click the plant name to go to the plant page. Choose **Layout**, click **Click to Upload**, and upload the physical layout template photo.

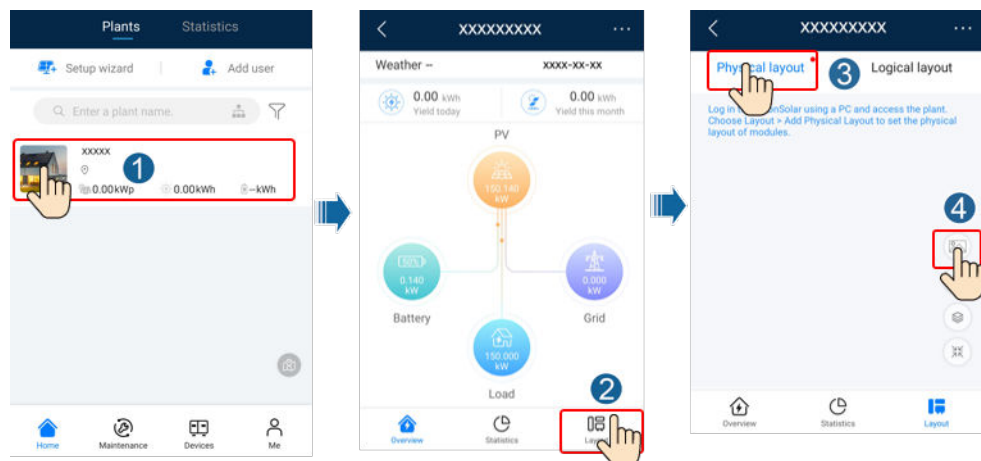
Figure 7-7 Uploading the physical layout template photo (WebUI)

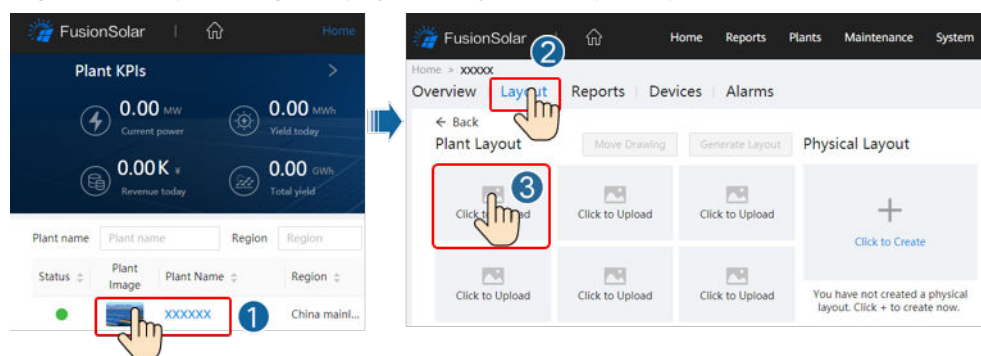

Step 2 Log in to <https://intl.fusionsolar.huawei.com> to access the WebUI of the FusionSolar Smart PV Management System. On the **Home** page, click the plant name to go to the plant page. Select **Layout**. Choose **Generate layout**, and create a physical layout as prompted. You can also manually create a physical location layout.

Figure 7-8 Physical layout design of PV modules

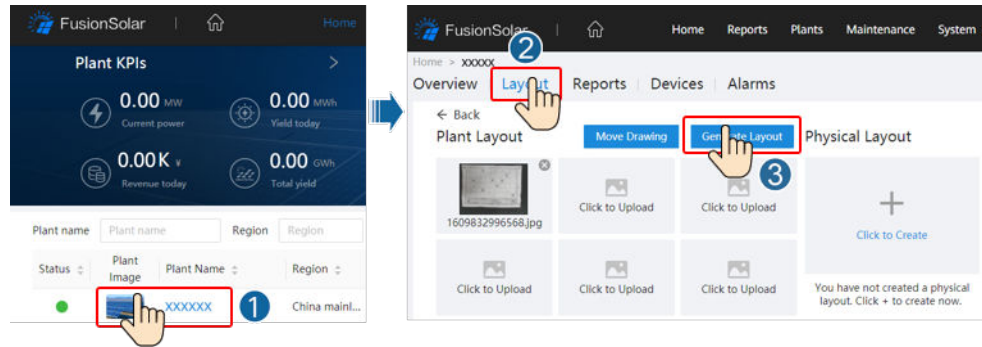

----End

Scenario 2: Setting on the Solar Inverter Side (Solar Inverter Not Connected to the Management System)

Step 1 Access the **Device Commissioning** screen on the FusionSolar app to set the physical layout of Smart PV Optimizers.

1. Log in to the FusionSolar app. On the **Device Commissioning** screen, choose **Maintenance > Optimizer layout**. The **Optimizer layout** screen is displayed.
2. Tap the blank area. The **Identify image** and **Add PV modules** buttons are displayed. You can use either of the following methods to perform operations as prompted:
 - Method 1: Tap **Identify image** and upload the physical layout template photo to complete the optimizer layout. (The optimizers that fail to be identified need to be manually bound.)
 - Method 2: Tap **Add PV modules** to manually add PV modules and bind the optimizers to the PV modules.

Figure 7-9 Physical layout design of PV modules

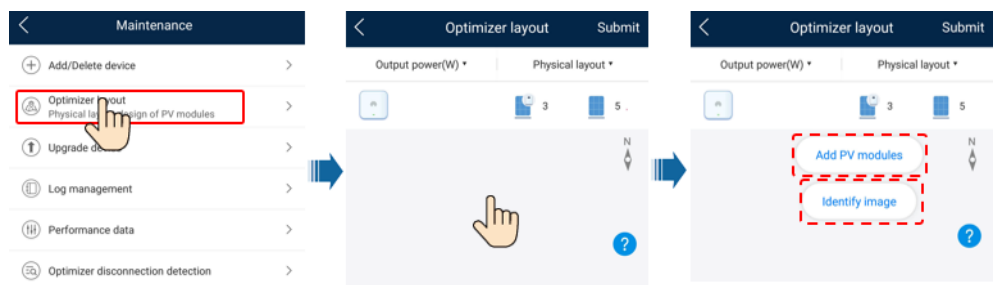

----End

7.1.5 Detecting Optimizer Disconnection

Log in to the FusionSolar app, choose **Device Commissioning > Maintenance > Optimizer disconnection detection**, tap the detection button to detect the optimizer disconnection, and rectify the fault based on the detection result.

Figure 7-10 Detect optimizer disconnection

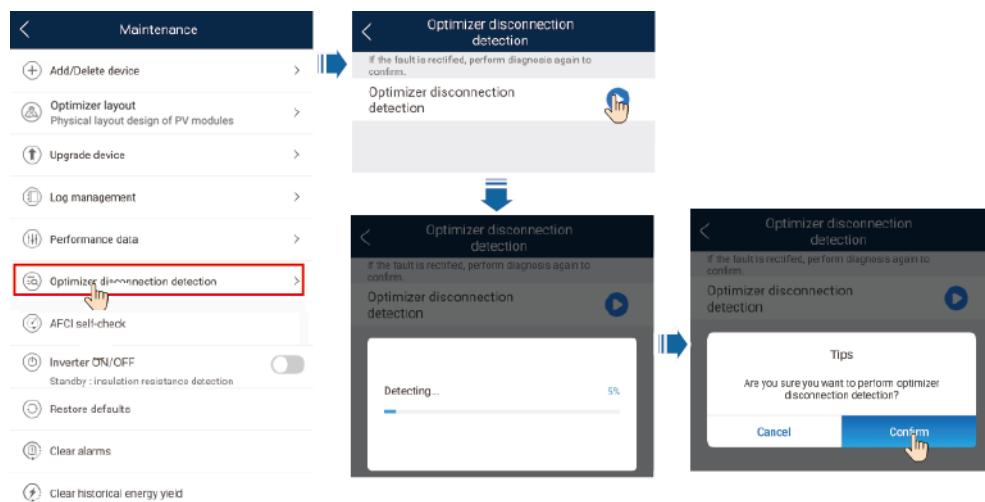

7.2 Parameters Settings

Go to the **Device Commissioning** screen and set SUN2000 parameters. For details about entering the **Device Commissioning** screen, see [B Device Commissioning](#).

To set more parameters, tap **Settings**. For details about the parameters, see the [FusionSolar APP and SUN2000 App User Manual](#). You can also scan the QR code to obtain the document.



7.2.1 Energy Control

7.2.1.1 Grid-tied Point Control

Function

Limits or reduces the output power of the PV power system to ensure that the output power is within the power deviation limit.

Procedure

Step 1 On the home screen, choose **Power adjustment > Grid-tied point control**.

Figure 7-11 Grid-tied point control

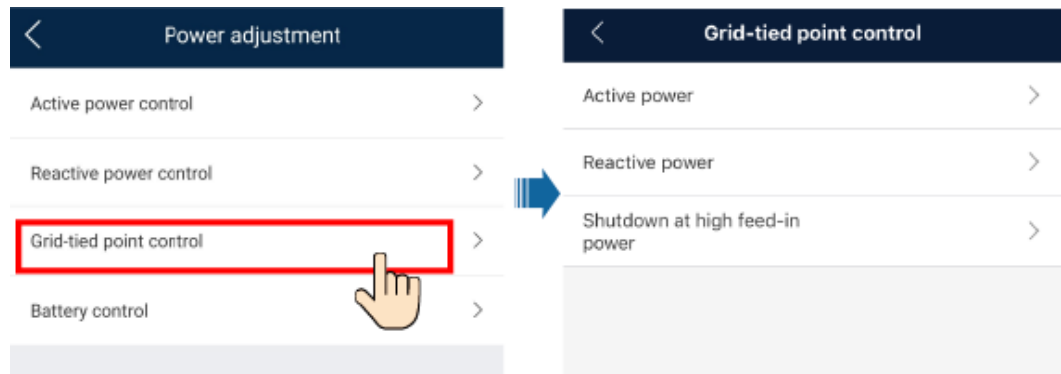

Table 7-1 Grid-tied point control

Parameter Name			Description
Active power	Unlimited	-	If this parameter is set to Unlimited , the output power of the SUN2000 is not limited and the SUN2000 can connect to the power grid at the rated power.
	Grid connection with zero power	Closed-loop controller	<ul style="list-style-type: none"> If multiple SUN2000s are cascaded, set this parameter to SDongle/SmartLogger. If there is only one SUN2000, set this parameter to Inverter.
		Limitation mode	Total power indicates export limitation of the total power at the grid-tied point.
		Power adjustment period	Specifies the shortest interval for a single anti-backfeeding adjustment.
		Power control hysteresis	Specifies the dead zone for adjusting the SUN2000 output power. If the power fluctuation is within the power control hysteresis, the power is not adjusted.
		Active power output limit for fail-safe	Specifies the derating value of the SUN2000 active power by percentage. If the Smart Dongle does not detect any meter data or the communication between the Smart Dongle and the SUN2000 is disconnected, the Smart Dongle delivers the derating value of the SUN2000 active power by percentage.

Parameter Name		Description
	Communication disconnection fail-safe	In the SUN2000 anti-backfeeding scenario, if this parameter is set to Enable , the SUN2000 will derate according to the active power derating percentage when the communication between the SUN2000 and the Smart Dongle is disconnected for a period longer than Communication disconnection detection time .
	Communication disconnection detection time	Specifies the time for determining the communication disconnection between the SUN2000 and the Dongle. This parameter is displayed when Communication disconnection fail-safe is set to Enable .
Grid connection with limited power (kW)	Closed-loop controller	<ul style="list-style-type: none"> • If multiple SUN2000s are cascaded, set this parameter to SDongle/SmartLogger. • If there is only one SUN2000, set this parameter to Inverter.
	Limitation mode	Total power indicates export limitation of the total power at the grid-tied point.
	Maximum grid feed-in power	Specifies the maximum active power transmitted from the grid-tied point to the power grid.
	Power adjustment period	Specifies the shortest interval for a single anti-backfeeding adjustment.
	Power control hysteresis	Specifies the dead zone for adjusting the SUN2000 output power. If the power fluctuation is within the power control hysteresis, the power is not adjusted.
	Active power output limit for fail-safe	Specifies the derating value of the SUN2000 active power by percentage. If the Smart Dongle does not detect any meter data or the communication between the Smart Dongle and the SUN2000 is disconnected, the Smart Dongle delivers the derating value of the SUN2000 active power by percentage.

Parameter Name		Description
	Communication disconnection fail-safe	In the SUN2000 anti-backfeeding scenario, if this parameter is set to Enable , the SUN2000 will derate according to the active power derating percentage when the communication between the SUN2000 and the Smart Dongle is disconnected for a period longer than Communication disconnection detection time .
	Communication disconnection detection time	Specifies the time for determining the communication disconnection between the SUN2000 and the Dongle. This parameter is displayed when Communication disconnection fail-safe is set to Enable .
Grid connection with limited power (%)	Closed-loop controller	<ul style="list-style-type: none"> • If multiple SUN2000s are cascaded, set this parameter to SDongle/SmartLogger. • If there is only one SUN2000, set this parameter to Inverter.
	Limitation mode	Total power indicates export limitation of the total power at the grid-tied point.
	PV plant capacity	Specifies the total maximum active power in the SUN2000 cascading scenario.
	Maximum grid feed-in power	Specifies the percentage of the maximum active power of the grid-tied point to the PV plant capacity.
	Power adjustment period	Specifies the shortest interval for a single anti-backfeeding adjustment.
	Power control hysteresis	Specifies the dead zone for adjusting the SUN2000 output power. If the power fluctuation is within the power control hysteresis, the power is not adjusted.

Parameter Name		Description
	Active power output limit for fail-safe	Specifies the derating value of the SUN2000 active power by percentage. If the Smart Dongle does not detect any meter data or the communication between the Smart Dongle and the SUN2000 is disconnected, the Smart Dongle delivers the derating value of the SUN2000 active power by percentage.
	Communication disconnection fail-safe	In the SUN2000 anti-backfeeding scenario, if this parameter is set to Enable , the SUN2000 will derate according to the active power derating percentage when the communication between the SUN2000 and the Smart Dongle is disconnected for a period longer than Communication disconnection detection time .
	Communication disconnection detection time	Specifies the time for determining the communication disconnection between the SUN2000 and the Dongle. This parameter is displayed when Communication disconnection fail-safe is set to Enable .
Shutdown at high feed-in power ^a	Shutdown at high feed-in power	<ul style="list-style-type: none"> The default value is Disable. If this parameter is set to Enable, the inverter shuts down for protection when the grid-connection point power exceeds the threshold and remains in this condition for the specified time threshold.
	Upper feed-in power threshold for inverter shutdown	<ul style="list-style-type: none"> The default value is 0. This parameter specifies the power threshold of the grid-connection point for triggering inverter shutdown.

Parameter Name		Description
	High feed-in power duration threshold for triggering inverter shutdown	<p>The default value is 20. This parameter specifies the duration threshold of high feed-in power for triggering inverter shutdown.</p> <ul style="list-style-type: none"> • When High feed-in power duration threshold for triggering inverter shutdown is set to 5, Shutdown at high feed-in power takes precedence. • When High feed-in power duration threshold for triggering inverter shutdown is set to 20, Limited feed-in takes precedence (when Active power control is set to Limited feed-in).
<p>Note a: This parameter is supported only for the AS4777 grid code.</p>		

----End

7.2.1.2 Apparent Power Control on the Inverter Output Side

On the home screen, tap **Settings > Power adjustment** to set inverter parameters.

Figure 7-12 Apparent power control

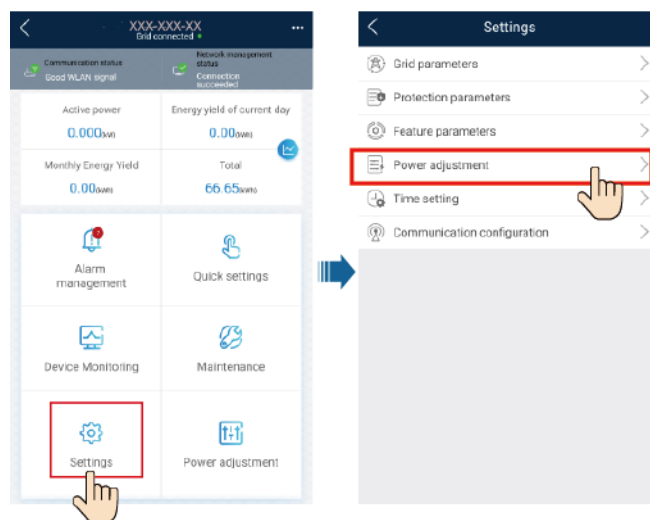

Table 7-2 Apparent power

Parameter	Description	Value Range
Maximum apparent power (kVA)	Specifies the output upper threshold for the maximum apparent power to adapt to the capacity requirements of standard and customized inverters.	[Maximum active power, S_{max}]
Maximum active power (kW)	Specifies the output upper threshold for the maximum active power to adapt to different market requirements.	[0.1, P_{max}]

 **NOTE**

The lower threshold for the maximum apparent power is the maximum active power. To lower the maximum apparent power, lower the maximum active power first.

7.2.2 AFCI

Function

If PV modules or cables are not properly connected or damaged, electric arcs may occur, which may cause fire. Huawei SUN2000s provide unique arc detection in compliance with UL 1699B-2018 to ensure the safety of users' lives and property.

This function is enabled by default. The SUN2000 automatically detects arc faults. To disable this function, log in to the FusionSolar app, enter the **Device Commissioning** screen, choose **Settings > Feature parameters**, and disable **AFCI**.

Clearing Alarms

The AFCI function involves the **DC arc fault** alarm.

The SUN2000 has the AFCI alarm automatic clearance mechanism. If an alarm is triggered for less than five times within 24 hours, the SUN2000 automatically clears the alarm. If the alarm is triggered for five times or more within 24 hours, the SUN2000 locks for protection. You need to manually clear the alarm on the SUN2000 so that it can work properly.

You can manually clear the alarm as follows:

- **Method 1:** FusionSolar App
Log in to the FusionSolar app and choose **My > Device Commissioning**. On the **Device Commissioning** screen, connect and log in to the SUN2000 that generates the AFCI alarm, tap **Alarm management**, and tap **Clear** on the right of the **DC arc fault** alarm to clear the alarm.

Figure 7-13 Alarm management

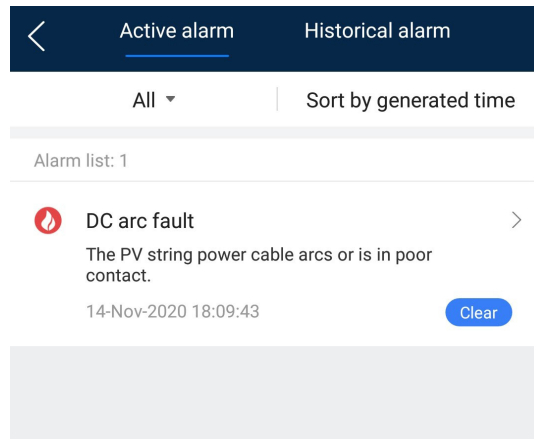

- **Method 2:** FusionSolar Smart PV Management System

Log in to the FusionSolar Smart PV Management System using a non-owner account, choose **Maintenance** > **Alarm Management**, select the **DC arc fault** alarm, and click **Clear** to clear the alarm.

Figure 7-14 Clearing alarms

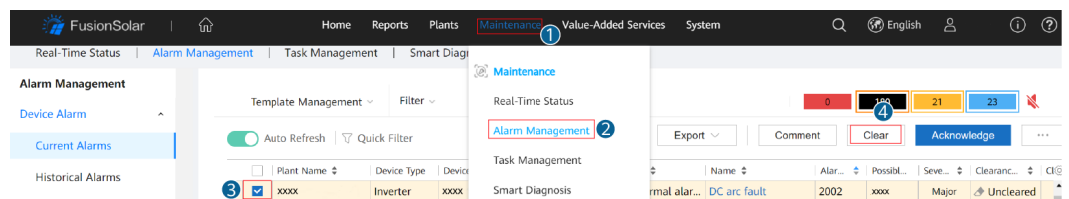

Switch to the owner account with PV plant management rights. On the home page, click the PV plant name to go to the PV plant page, and click **OK** as prompted to clear the alarm.

7.2.3 IPS Check (for Italy CEI0-21 Grid Code Only)

Function

The Italy CEI0-21 grid code requires an IPS check for the SUN2000. During the self-check, the SUN2000 checks the protection threshold and protection time of the maximum voltage over 10 min (59.S1), maximum overvoltage (59.S2), minimum undervoltage (27.S1), minimum undervoltage (27.S2), maximum overfrequency (81.S1), maximum overfrequency (81.S2), minimum underfrequency (81.S), and minimum underfrequency (81.S2).

Procedure

- Step 1** On the home screen, choose **Maintenance** > **IPS test** to access the IPS test screen.
- Step 2** Tap **Start** to start an IPS test. The SUN2000 detects maximum voltage over 10 min (59.S1), maximum overvoltage (59.S2), minimum undervoltage (27.S1), minimum undervoltage (27.S2), maximum overfrequency (81.S1), maximum overfrequency (81.S2), and minimum underfrequency (81.S1), and minimum underfrequency (81.S2).

Figure 7-15 IPS test

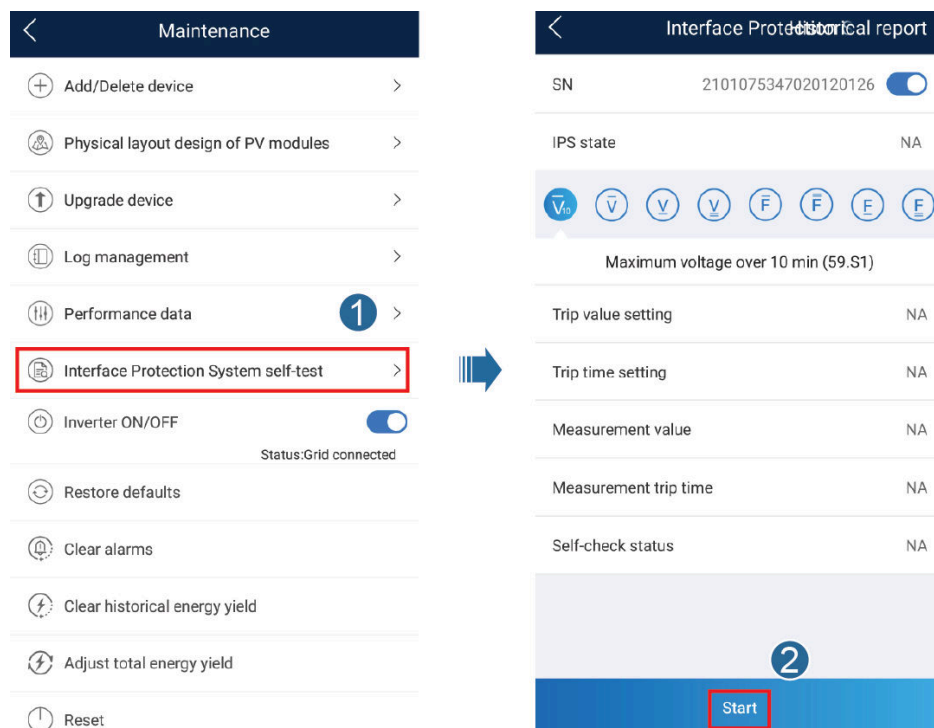

Table 7-3 IPS test type

IPS Test Type	Description
Maximum voltage over 10 min (59.S1)	The default maximum voltage over 10 min protection threshold is 253 V (1.10 Vn), and the default protection time threshold is 3s.
Maximum overvoltage (59.S2)	The default overvoltage protection threshold is 264.5 V (1.15 Vn), and the default protection time threshold is 0.2s.
Minimum undervoltage (27.S1)	The default undervoltage protection threshold is 195.5 V (0.85 Vn), and the default protection time threshold is 1.5s.
Minimum undervoltage (27.S2)	The default undervoltage protection threshold is 34.5 V (0.15 Vn), and the default protection time threshold is 0.2s.
Maximum overfrequency (81.S1)	The default overfrequency protection threshold is 50.2 Hz, and the default protection time threshold is 0.1s.
Maximum overfrequency (81.S2)	The default overfrequency protection threshold is 51.5 Hz, and the default protection time threshold is 0.1s.

IPS Test Type	Description
Minimum underfrequency (81.S1)	The default underfrequency protection threshold is 49.8 Hz, and the default protection time threshold is 0.1s.
Minimum underfrequency (81.S2)	The default underfrequency protection threshold is 47.5 Hz, and the default protection time threshold is 0.1s.

Step 3 After the IPS test is complete, **IPS State** is displayed as **IPS state success**. Tap **Historical report** in the upper right corner of the screen to view the IPS check report.

----End

7.3 SmartLogger Networking Scenario

See the [Distributed PV Plants Connecting to Huawei Hosting Cloud Quick Guide \(Distributed Inverters + SmartLogger1000A + RS485 Networking\)](#) and [PV Plants Connecting to Huawei Hosting Cloud Quick Guide \(Inverters + SmartLogger3000 + RS485 Networking\)](#). You can scan the QR code to obtain it.

Figure 7-16 SmartLogger1000A



Figure 7-17 SmartLogger3000



8 Maintenance

8.1 System Power-Off

Precautions

WARNING

- After the SUN2000 powers off, the remaining electricity and heat may still cause electric shocks and body burns. Therefore, put on protective gloves and begin operating the SUN2000 five minutes after the power-off.
- Before maintaining the optimizers and PV strings, power off the system by performing the following steps. Otherwise, the PV strings may be energized, resulting in electric shocks.

Procedure

- Step 1** Send a shutdown command on the app.
- Step 2** Turn off the AC switch between the SUN2000 and the power grid.
- Step 3** Turn off the DC switch at the bottom of the SUN2000.
- Step 4** (Optional) Install the locking screw for the DC switch.

Figure 8-1 Installing a locking screw for the DC switch

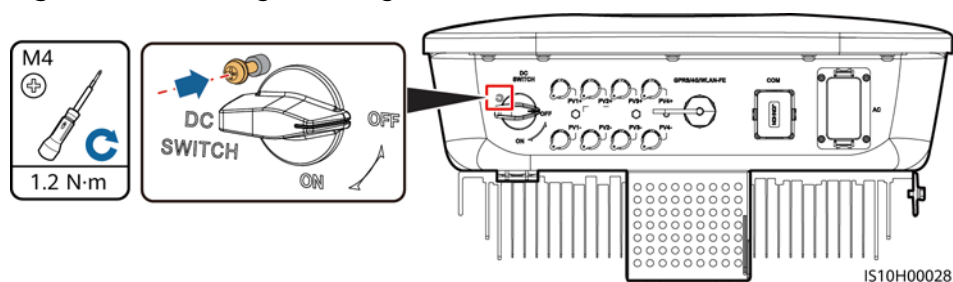

Step 5 Turn off the DC switch between the SUN2000 and PV strings.

----End

8.2 Routine Maintenance

To ensure that the SUN2000 can operate properly for a long term, you are advised to perform routine maintenance on it as described in this chapter.

CAUTION

Before cleaning the system, connecting cables, and maintaining the grounding reliability, power off the system.

Table 8-1 Maintenance list

Check Detail	Check Method	Maintenance Interval
System cleanliness	Check the heat sink for foreign matter or the overall health of the SUN2000.	Annual or every time an abnormality is detected
System running status	Check the SUN2000 for damage or deformation.	Annual
Electrical connections	<ul style="list-style-type: none"> • Cables are securely connected. • Cables are intact, in particular, the parts touching the metallic surface are not scratched. 	The first inspection is 6 months after the initial commissioning. From then on, the interval can be 6 to 12 months.
Grounding reliability	Check whether the ground terminal and ground cable are securely connected.	Annual
Sealing	Check whether all terminals and ports are properly sealed.	Annual

8.3 Troubleshooting

NOTE

Contact your dealer or Huawei technical support if the measures listed in the **Troubleshooting Suggestion** column have been taken but the fault persists.

Alarm severities are defined as follows:

- Major: The inverter is faulty. As a result, the output power decreases or the grid-tied power generation is stopped.
- Minor: Some components are faulty without affecting the grid-tied power generation.

- Warning: The inverter works properly. The output power decreases or some authorization functions fail due to external factors.

Table 8-2 Common alarms and troubleshooting measures

Alarm ID	Alarm Name	Alarm Severity	Possible Cause	Troubleshooting Suggestion
2001	High String Input Voltage	Major	The PV array is not properly configured. Excessive PV modules are connected in series to the PV string, and therefore the open-circuit voltage exceeds the maximum inverter operating voltage. Cause ID 1 = PV1 and PV2 Cause ID 2 = PV3 and PV4	Reduce the number of PV modules connected in series to the PV string until the PV string open-circuit voltage is less than or equal to the maximum inverter operating voltage. After the PV array is correctly configured, the inverter alarm disappears.
2002	DC Arc Fault	Major	The PV string power cable arcs or is in poor contact. Cause ID 1 = PV1 and PV2 Cause ID 2 = PV3 and PV4	Check that the PV string power cable does not arc and is in good contact.
2011	String Reverse Connection	Major	The PV string polarity is reversed. Cause ID 1 = PV1 Cause ID 2 = PV2 Cause ID 3 = PV3 Cause ID 4 = PV4	Check whether the PV string is reversely connected to the SUN2000. If yes, wait until the PV string current decreases below 0.5 A, set DC SWITCH to OFF , and adjust the PV string polarity.

Alarm ID	Alarm Name	Alarm Severity	Possible Cause	Troubleshooting Suggestion
2012	String Current Backfeed	Warning	<p>The number of PV modules connected in series to this PV string is insufficient. As a result, the end voltage is lower than that of other strings.</p> <p>Cause ID 1 = PV1 Cause ID 2 = PV2 Cause ID 3 = PV3 Cause ID 4 = PV4</p>	<ol style="list-style-type: none"> 1. Check whether the number of PV modules connected in series to this PV string is less than the number of PV modules connected in series to the other PV strings connected in parallel with this PV string. If yes, wait until the PV string current decreases below 0.5 A, set DC SWITCH to OFF, and adjust the number of PV modules in the PV string. 2. Check whether the PV string is shaded. 3. Check whether the open-circuit voltage of the PV string is normal.
2021	AFCI Self-Check Failure	Major	Cause ID = 1, 2 AFCI check fails.	Turn off the AC output switch and DC input switch, and then turn them on after 5 minutes. If the fault persists, contact your dealer or Huawei technical support.
2031	Phase Wire Short-Circuited to PE	Major	Cause ID = 1 The impedance of the output phase wire to PE is low or the output phase wire is short-circuited to PE.	Check the impedance of the output phase wire to PE, locate the position with lower impedance, and rectify the fault.
2032	Grid Loss	Major	<p>Cause ID = 1</p> <ul style="list-style-type: none"> • The power grid experiences an outage. • The AC power cable is disconnected or the AC circuit breaker is OFF. 	<ol style="list-style-type: none"> 1. Check that the AC voltage is normal. 2. Check that the AC power cable is connected and that the AC switch is ON.

Alarm ID	Alarm Name	Alarm Severity	Possible Cause	Troubleshooting Suggestion
2033	Grid Undervoltage	Major	Cause ID = 1 The grid voltage is below the lower threshold or the low voltage duration has lasted for more than the value specified by LVRT.	<ol style="list-style-type: none"> 1. If the alarm occurs accidentally, the power grid may be abnormal temporarily. The inverter automatically recovers after detecting that the power grid becomes normal. 2. If the alarm occurs frequently, check whether the grid voltage is within the acceptable range. If no, contact the local power operator. If yes, login to the mobile phone app, SmartLogger, or NMS to modify the grid undervoltage protection threshold with the consent of the local power operator. 3. If the fault persists, check the connection between the AC switch and the output power cable.
2034	Grid Overvoltage	Major	Cause ID = 1 The grid voltage exceeds the higher threshold or the high voltage duration has lasted for more than the value specified by HVRT.	<ol style="list-style-type: none"> 1. If the alarm occurs accidentally, the power grid may be abnormal temporarily. The inverter automatically recovers after detecting that the power grid becomes normal. 2. If the alarm occurs frequently, check whether the power grid voltage is within the acceptable range. If no, contact the local power operator. If yes, log in to the mobile app, SmartLogger, or network management system (NMS) to modify the grid overvoltage protection threshold with the consent of the local power operator. 3. Check whether the peak voltage of the power grid is too high. If the fault persists and cannot be rectified for a long time, contact the power grid operator.

Alarm ID	Alarm Name	Alarm Severity	Possible Cause	Troubleshooting Suggestion
2035	Grid Voltage Imbalance	Major	Cause ID = 1 The difference between grid phase voltages exceeds the upper threshold.	<ol style="list-style-type: none"> 1. If the alarm occurs accidentally, the power grid may be abnormal temporarily. The inverter automatically recovers after detecting that the power grid becomes normal. 2. If the alarm occurs frequently, check whether the power grid voltage is within the acceptable range. If no, contact the local power operator. 3. If the fault persists for a long time, check the connection of the AC output power cables. 4. If the AC output power cables are correctly connected, but the alarm persists and affects the energy yield of the PV plant, contact the local power operator.
2036	Grid Overfrequency	Major	Cause ID = 1 Power grid exception: The actual grid frequency is higher than the requirement of the local power grid standard.	<ol style="list-style-type: none"> 1. If the alarm occurs accidentally, the power grid may be abnormal temporarily. The inverter automatically recovers after detecting that the power grid becomes normal. 2. If the alarm occurs frequently, check whether the grid frequency is within the acceptable range. If no, contact the local power operator. If yes, log in to the mobile phone app, SmartLogger, or NMS to modify the grid underfrequency protection threshold with the consent of the local power operator.

Alarm ID	Alarm Name	Alarm Severity	Possible Cause	Troubleshooting Suggestion
2037	Grid Underfrequency	Major	Cause ID = 1 Power grid exception: The actual grid frequency is lower than the requirement of the local power grid standard.	<ol style="list-style-type: none"> 1. If the alarm occurs accidentally, the power grid may be abnormal temporarily. The inverter automatically recovers after detecting that the power grid becomes normal. 2. If the alarm occurs frequently, check whether the grid frequency is within the acceptable range. If no, contact the local power operator. If yes, log in to the mobile phone app, SmartLogger, or NMS to modify the grid underfrequency protection threshold with the consent of the local power operator.
2038	Unstable Grid Frequency	Major	Cause ID = 1 Power grid exception: The actual grid frequency change rate does not comply with the local power grid standard.	<ol style="list-style-type: none"> 1. If the alarm occurs accidentally, the power grid may be abnormal temporarily. The inverter automatically recovers after detecting that the power grid becomes normal. 2. If the alarm occurs frequently, check whether the grid frequency is within the acceptable range. If no, contact the local power operator.
2039	Output Overcurrent	Major	Cause ID = 1 The grid voltage drops dramatically or the power grid is short-circuited. As a result, the inverter transient output current exceeds the upper threshold, and inverter protection is triggered.	<ol style="list-style-type: none"> 1. The inverter monitors its external working conditions in real time. The inverter automatically recovers after the fault is rectified. 2. If the alarm occurs frequently and affects the power production of the PV plant, check whether the output is short-circuited. If the fault persists, contact your dealer or Huawei technical support.

Alarm ID	Alarm Name	Alarm Severity	Possible Cause	Troubleshooting Suggestion
2040	Output DC Component Overhigh	Major	Cause ID = 1 The DC component in the grid current exceeds the upper threshold.	<ol style="list-style-type: none"> 1. The inverter monitors its external working conditions in real time. The inverter automatically recovers after the fault is rectified. 2. If the alarm occurs frequently, contact your dealer or Huawei technical support.
2051	Abnormal Residual Current	Major	Cause ID = 1 The input-to-ground insulation impedance has decreased during the inverter operation.	<ol style="list-style-type: none"> 1. If the alarm occurs accidentally, the external power cable may be abnormal temporarily. The inverter automatically recovers after the fault is rectified. 2. If the alarm occurs frequently or persists, check that the impedance between the PV string and ground is not below the lower threshold.
2061	Abnormal Grounding	Major	Cause ID = 1 <ul style="list-style-type: none"> • The neutral wire or ground cable is not connected. • The PV array is grounded, but the inverter output does not connect to an isolation transformer. 	Power off the inverter (turn off the AC output switch and DC input switch, and wait for 5 minutes), and then perform the following operations: <ol style="list-style-type: none"> 1. Check that the PE cable for the inverter is connected properly. 2. If the inverter is connected to the TN power grid, check whether the N cable is properly connected and whether the voltage to ground is normal. 3. Check whether the AC output connects to an isolation transformer. If yes, after powering on the inverter, log in to the mobile phone app, SmartLogger, or NMS and disable Grounding inspection.

Alarm ID	Alarm Name	Alarm Severity	Possible Cause	Troubleshooting Suggestion
2062	Low Insulation Resistance	Major	Cause ID = 1 <ul style="list-style-type: none"> The PV array is short-circuited to ground. The PV array is in a moist environment and the power cable is not well insulated to ground. 	<ol style="list-style-type: none"> Check the impedance between the PV array output and PE, and eliminate short circuits and poor insulation points. Check that the PE cable for the inverter is connected correctly. If you are sure that the impedance is less than the preset protection threshold in a cloudy or rainy environment, log in to the mobile phone app, SmartLogger, or NMS and reset the insulation impedance protection threshold.
2063	Cabinet Overtemperature	Minor	Cause ID = 1 <ul style="list-style-type: none"> The inverter is installed in a place with poor ventilation. The ambient temperature exceeds the upper threshold. The inverter is not working properly. 	<ul style="list-style-type: none"> Check the ventilation and ambient temperature at the inverter installation position. If the ventilation is poor or the ambient temperature exceeds the upper threshold, improve the ventilation and heat dissipation. If the ventilation and ambient temperature both meet requirements, contact your dealer or Huawei technical support.
2064	Device Fault	Major	Cause ID = 1-12 An unrecoverable fault has occurred on a circuit inside the inverter.	Turn off the AC output switch and DC input switch, and then turn them on after 5 minutes. If the fault persists, contact your dealer or Huawei technical support. Note: If the cause ID is ID 1, perform the preceding operation when the PV string current is less than 1 A.

Alarm ID	Alarm Name	Alarm Severity	Possible Cause	Troubleshooting Suggestion
2065	Upgrade Failed or Version Mismatch	Minor	Cause ID = 1, 2 and 4 The upgrade ends abnormally. NOTE Upgrade the inverter again if it is stuck in initialization state without generating any alarms and cannot be restored to the normal state during the upgrade when the PV inputs are disconnected and reconnected next time.	<ol style="list-style-type: none">1. Upgrade again.2. If the upgrade fails several times, contact your dealer or Huawei technical support.
2066	License Expired	Warning	Cause ID = 1 <ul style="list-style-type: none">• The privilege certificate has entered the grace period.• The privilege feature will be invalid soon.	<ol style="list-style-type: none">1. Apply for a new certificate.2. Load the new certificate.
61440	Faulty Monitoring Unit	Minor	Cause ID = 1 <ul style="list-style-type: none">• The flash memory is insufficient.• The flash memory has bad sectors.	Turn off the AC output switch and DC input switch, and then turn them on after 5 minutes. If the fault persists, replace the monitoring board or contact your dealer Huawei technical support.
2067	Faulty Power Collector	Major	Cause ID = 1 Power meter disconnection.	<ol style="list-style-type: none">1. Check that the preset power meter model is the same as the actual model.2. Check that the preset communications parameters for the power meter are the same as the actual configurations.3. Check that the power meter is powered on and the RS485 communications cable is connected.

Alarm ID	Alarm Name	Alarm Severity	Possible Cause	Troubleshooting Suggestion
2072	Transient AC Overvoltage	Major	Cause ID = 1 The inverter detects that the phase voltage exceeds the transient AC overvoltage protection threshold.	<ol style="list-style-type: none"> 1. Check whether the grid connection voltage exceeds the upper threshold. If yes, contact the local power operator. 2. If you have confirmed that the grid connection voltage exceeds the upper threshold and obtained the consent of the local power operator, modify the overvoltage protection threshold. 3. Check that the peak grid voltage does not exceed the upper threshold.

Alarm ID	Alarm Name	Alarm Severity	Possible Cause	Troubleshooting Suggestion
2080	Abnormal PV Module Configuration	Major	<p>PV module configuration does not meet requirements, or the PV module output is reversely connected or short-circuited.</p> <p>Cause ID = 2, 3, 6, 7, 8, 9</p> <ul style="list-style-type: none"> ● 2: The PV string power or the number of PV modules connected in series exceeds the upper threshold. ● 3: The PV string voltage is low or the number of PV modules connected in series is less than the lower threshold. ● 6: The PV string or parallel connection is abnormal. ● 7: The string configuration is changed. ● 8: The sunlight is abnormal. ● 9: The PV string voltage exceeds the upper threshold. 	<p>Check whether the total number of PV modules, number of PV modules in a string, and number of PV strings meet requirements and whether the PV module output is reversely connected.</p> <ul style="list-style-type: none"> ● ID2: Check whether the PV string power or the number of PV modules connected in series in the PV string exceeds the upper threshold. ● ID3: <ol style="list-style-type: none"> 1. Check whether the number of optimizers connected in series in the PV string is below the lower threshold. 2. Check whether the PV string output is reversely connected. 3. Check whether the PV string output is disconnected. 4. Check whether the optimizer output extension cable is correct (positive connector at one end and negative connector at the other). ● ID6: <ol style="list-style-type: none"> 1. Check whether the number of optimizers connected in series in the PV strings connected in parallel under the same MPPT is the same. 2. Check whether the optimizer output extension cable is correct (positive connector at one end and negative connector at the other). ● ID7: When the sunlight is normal, perform the optimizer search function again. ● ID8: When the sunlight is normal, perform the optimizer search function again. ● ID9: Calculate the PV string voltage based on the number of PV modules in the PV string and check whether the PV string

Alarm ID	Alarm Name	Alarm Severity	Possible Cause	Troubleshooting Suggestion
				voltage exceeds the upper threshold of the inverter input voltage.
2081	Optimizer Fault	Warning	Cause ID = 1 An optimizer is faulty.	Go to the optimizer information page to view the fault information.

9 Handling the Inverter

9.1 Removing a SUN2000

Procedure

- Step 1** Power off the SUN2000. For details, see [8.1 System Power-Off](#).
 - Step 2** Disconnect all cables from the SUN2000, including signal cables, DC input power cables, AC output power cables, and PE cables.
 - Step 3** (Optional) Remove the Smart Dongle from the SUN2000.
 - Step 4** Remove the SUN2000 from the mounting bracket.
 - Step 5** Remove the mounting bracket.
- End

9.2 Packing the SUN2000

- If the original packing materials are available, put the SUN2000 inside them and then seal them by using adhesive tape.
- If the original packing materials are not available, put the SUN2000 inside a suitable cardboard box and seal it properly.

9.3 Disposing of the SUN2000

If the SUN2000 service life expires, dispose of it according to the local disposal rules for electrical equipment waste.

10 Technical Data

10.1 SUN2000 Technical Specifications

Efficiency

Technical Specifications	SUN2000-8KTL-M2	SUN2000-10KTL-M2	SUN2000-12KTL-M2	SUN2000-15KTL-M2	SUN2000-17KTL-M2	SUN2000-20KTL-M2
Maximum efficiency	98.5%	98.5%	98.5%	98.65%	98.65%	98.65%
European efficiency	98.0%	98.0%	98.0%	98.3%	98.3%	98.3%

Input

Technical Specifications	SUN2000-8KTL-M2	SUN2000-10KTL-M2	SUN2000-12KTL-M2	SUN2000-15KTL-M2	SUN2000-17KTL-M2	SUN2000-20KTL-M2
Maximum input voltage ^a	1080 V					
Maximum input current (per MPPT)	22 A/27 A (Subject to the product nameplate)					
Maximum short-circuit current (per MPPT)	30 A/39 A (Subject to the product nameplate)					

Technical Specifications	SUN2000-8KTL-M2	SUN2000-10KTL-M2	SUN2000-12KTL-M2	SUN2000-15KTL-M2	SUN2000-17KTL-M2	SUN2000-20KTL-M2
Maximum inverter backfeed current to the PV array	0 A					
Minimum startup voltage	200 V					
Operating voltage range ^b	160–950 V					
Full-load MPPT voltage range	320–850 V	320–850 V	380–850 V	380–850 V	400–850 V	480–850 V
Rated input voltage	600 V					
Number of input routes	4					
Number of MPP trackers	2					
<p>Note a: The maximum input voltage is the upper threshold of the DC voltage. If the input voltage exceeds the threshold, the solar inverter may be damaged.</p> <p>Note b: If the input voltage is beyond the operating voltage range, the solar inverter cannot work properly.</p>						

Output

Technical Specifications	SUN2000-8KTL-M2	SUN2000-10KTL-M2	SUN2000-12KTL-M2	SUN2000-15KTL-M2	SUN2000-17KTL-M2	SUN2000-20KTL-M2
Rated active power	8000 W	10000 W	12000 W	15000 W	17000 W	20000 W
Maximum apparent power	8800 VA	11000 VA	13200 VA	16500 VA	18700 VA	22000 VA
Maximum active power (cosφ = 1)	8800 W	11000 W	13200 W	16500 W	18700 W	22000 W
Rated output voltage	220/380 V, 230/400 V, 3W + (N) + PE					
Rated output current	12.8 A (380 V)/ 11.6 A (400 V)	15.9 A (380 V)/ 14.5 A (400 V)	18.2 A (380 V)/ 17.3 A (400 V)	22.8 A (380 V)/ 21.7 A (400 V)	25.8 A (380 V)/ 24.6 A (400 V)	30.4 A (380 V)/ 28.9 A (400 V)

Technical Specifications	SUN2000-8KTL-M2	SUN2000-10KTL-M2	SUN2000-12KTL-M2	SUN2000-15KTL-M2	SUN2000-17KTL-M2	SUN2000-20KTL-M2
Maximum output current	13.4 A	17 A	20 A	25.2 A	28.5 A	33.5 A
Rated apparent power	8 kVA	10 kVA	12 kVA	15 kVA	17 kVA	20 kVA
Inrush current	13.4 A	17 A	20 A	25.2 A	28.5 A	33.5 A
Max output fault current	40.16 A	50.2 A	60.2 A	75.3 A	85.34 A	100.4 A
Max output overcurrent protection	48.8 A	48.8 A	48.8 A	48.8 A	48.8 A	48.8 A
Adapted power grid frequency	50/60 Hz					
Power factor	0.8 leading... 0.8 lagging					
Maximum total harmonic distortion (rated power)	< 3%					

Protection and Feature

Technical Specifications	SUN2000-8KTL-M2	SUN2000-10KTL-M2	SUN2000-12KTL-M2	SUN2000-15KTL-M2	SUN2000-17KTL-M2	SUN2000-20KTL-M2
Overvoltage category	PV II/AC III					
Input DC switch	Supported					
Islanding protection	Supported					
Output overcurrent protection	Supported					
Input reverse connection protection	Supported					
PV string fault detection	Supported					
DC surge protection	DC common mode: 20 kA					

Technical Specifications	SUN2000-8KTL-M2	SUN2000-10KTL-M2	SUN2000-12KTL-M2	SUN2000-15KTL-M2	SUN2000-17KTL-M2	SUN2000-20KTL-M2
AC surge protection	Common mode: 5 kA; differential mode: 5 kA					
Insulation resistance detection	Supported					
RCD detection	Supported					
PV module safe shutdown, optimizer	Optional					
PID repair	Supported					
AFCI	Supported					
Active anti-islanding method	AFD					
Protection class	I					
PV and AC port	DVCC					
Communication port	DVCA					

Display and Communication

Technical Specifications	SUN2000-8KTL-M2	SUN2000-10KTL-M2	SUN2000-12KTL-M2	SUN2000-15KTL-M2	SUN2000-17KTL-M2	SUN2000-20KTL-M2
Display	LED indicators; WLAN + app					
RS485	Supported					
Communication expansion module	(Optional) WLAN/GPRS/4G					
remote ripple control	Supported					

NOTE

When the DC input voltage of the inverter is less than 160 V, the inverter shuts down without communication.

Common Parameters

Technical Specifications	SUN2000-8KTL-M2	SUN2000-10KTL-M2	SUN2000-12KTL-M2	SUN2000-15KTL-M2	SUN2000-17KTL-M2	SUN2000-20KTL-M2
Dimensions (W x H x D)	525 mm × 470 mm × 262 mm (including only the rear mounting kit of the SUN2000)					
Net weight	25 kg (including only the rear mounting kit of the SUN2000)					
Noise	29 dB (A) (typical working condition)					
Operating temperature	-25°C to +60°C (derated when the temperature is higher than 45°C)					
Operating humidity	0-100% RH					
Cooling mode	Natural convection					
Maximum operating altitude	4000 m (derated when the altitude is greater than 2000 m)					
Storage temperature	-40°C to +70°C					
Storage humidity	5-95% RH (non-condensing)					
Input terminal	Staubli MC4					
Output terminal	Waterproof quick-connect terminal					
IP rating	IP65					
Topology	Non-Isolation					
Environmental protection requirements	RoHS 6					

10.2 Optimizer Technical Specifications

Efficiency

Technical Specifications	SUN2000-450W-P
Maximum efficiency	99.5%
European weighted efficiency	99.0%

Input

Technical Specifications	SUN2000-450W-P
Rated PV module power	450 W
Maximum PV module power	472.5 W
Maximum input voltage	80 V
MPPT voltage range	8–80 V
Maximum short-circuit current	13 A
Overtoltage level	II

Output

Technical Specifications	SUN2000-450W-P
Rated output power	450 W
Output voltage	4–80 V
Maximum output current	15 A
Output bypass	Yes
Shutdown output voltage/impedance	0 V/1 k Ω ($\pm 10\%$)

Common Parameters

Technical Specifications	SUN2000-450W-P
Dimensions (W x H x D)	71 mm x 138 mm x 25 mm
Net weight	≤ 550 g
DC input and output terminals	Staubli MC4

Technical Specifications	SUN2000-450W-P
Operating temperature	-40°C to +85°C
Storage temperature	-40°C to +70°C
Operating humidity	0-100% RH
Maximum operating altitude	4000 m
IP rating	IP68
Installation mode	<ul style="list-style-type: none"> • PV module support installation • PV module frame installation

Long String Design (Full Optimizer Configuration)

Technical Specifications	SUN2000-8 KTL-M2	SUN2000-10KTL-M2	SUN2000-12KTL-M2	SUN2000-15KTL-M2	SUN2000-17KTL-M2	SUN2000-20KTL-M2
Minimum optimizer number per string	6					
Maximum optimizer number per string	50					
Maximum DC power per string	10,000 W					

A Grid Codes

NOTE

The grid codes are subject to change. The listed codes are for your reference only.

Table A-1 Grid Codes

National/ Regional Grid Code	Descripti on	SUN2000 -8KTL-M2	SUN2000 -10KTL- M2	SUN2000 -12KTL- M2	SUN2000 -15KTL- M2	SUN2000 -17KTL- M2	SUN2000 -20KTL- M2
VDE-AR- N-4105	Germany low- voltage power grid	Supported	Supported	Supported	Supported	Supported	Supported
UTE C 15-712-1 (A)	France mainland low- voltage power grid	Supported	Supported	Supported	Supported	Supported	Supported
UTE C 15-712-1 (B)	France island power grid (230 V 50 Hz)	Supported	Supported	Supported	Supported	Supported	Supported
UTE C 15-712-1 (C)	France island power grid (230 V 60 Hz)	Supported	Supported	Supported	Supported	Supported	Supported

National/ Regional Grid Code	Descripti on	SUN2000 -8KTL-M2	SUN2000 -10KTL- M2	SUN2000 -12KTL- M2	SUN2000 -15KTL- M2	SUN2000 -17KTL- M2	SUN2000 -20KTL- M2
CEI0-21	Italy low- voltage power grid	Supported	Supported	Supported	Supported	Supported	Supported
EN50438- CZ	Czech Republic low- voltage power grid	Supported	Supported	Supported	Supported	Supported	Supported
RD1699/66 1	Spain low- voltage power grid	Supported	Supported	Supported	Supported	Supported	Supported
EN50438- NL	Netherla nds low- voltage power grid	Supported	Supported	Supported	Supported	Supported	Supported
C10/11	Belgium low- voltage power grid	Supported	Supported	Supported	Supported	Supported	Supported
IEC61727	IEC61727 low- voltage power grid (50 Hz)	Supported	Supported	Supported	Supported	Supported	Supported
User- defined (50 Hz)	Reserved	Supported	Supported	Supported	Supported	Supported	Supported
User- defined (60 Hz)	Reserved	Supported	Supported	Supported	Supported	Supported	Supported
CEI0-16	Italy low- voltage power grid	Supported	Supported	Supported	Supported	Supported	Supported

National/ Regional Grid Code	Descripti on	SUN2000 -8KTL-M2	SUN2000 -10KTL- M2	SUN2000 -12KTL- M2	SUN2000 -15KTL- M2	SUN2000 -17KTL- M2	SUN2000 -20KTL- M2
TAI-PEA	Thailand low- voltage power grid (PEA)	Supported	Supported	Supported	Supported	Supported	Supported
TAI-MEA	Thailand low- voltage power grid (MEA)	Supported	Supported	Supported	Supported	Supported	Supported
EN50438- TR	Turkey low- voltage power grid	Supported	Supported	Supported	Supported	Supported	Supported
IEC61727- 60Hz	IEC61727 low- voltage power grid (60 Hz)	Supported	Supported	Supported	Supported	Supported	Supported
EN50438_I E	Ireland low- voltage power grid	Supported	Supported	Supported	Supported	Supported	Supported
PO12.3	Spain low- voltage power grid	Supported	Supported	Supported	Supported	Supported	Supported
EN50549- LV	Ireland power grid	Supported	Supported	Supported	Supported	Supported	Supported
ABNT NBR 16149	Brazil low- voltage power grid	Supported	Supported	Supported	Supported	Supported	Supported

National/ Regional Grid Code	Descripti on	SUN2000 -8KTL-M2	SUN2000 -10KTL- M2	SUN2000 -12KTL- M2	SUN2000 -15KTL- M2	SUN2000 -17KTL- M2	SUN2000 -20KTL- M2
DUBAI	Dubai low- voltage power grid	Supported	Supported	Supported	Supported	Supported	Supported
TAIPOWER	Taiwan low- voltage power grid	Supported	Supported	Supported	Supported	Supported	Supported
EN50438- SE	Sweden LV	Supported	Supported	Supported	Supported	Supported	Supported
EN50549- SE	Sweden LV	Supported	Supported	Supported	Supported	Supported	Supported
Austria	Austria	Supported	Supported	Supported	Supported	Supported	Supported
G98	United Kingdom G98	Supported	Supported	N/A	N/A	N/A	N/A
G99- TYPEA-LV	United Kingdom G99- TypeA-LV	Supported	Supported	Supported	Supported	Supported	Supported
VDE-AR- N4110	Germany 230 V MV	Supported	Supported	Supported	Supported	Supported	Supported
SINGAPOR E	Singapor e LV power grid	Supported	Supported	Supported	Supported	Supported	Supported
HONGKO NG	Hong Kong LV power grid	Supported	Supported	Supported	Supported	Supported	Supported
EN50549- PL	Poland	Supported	Supported	Supported	Supported	Supported	Supported
EN50549- MV400	Ireland New standard	-	-	Supported	Supported	Supported	Supported

National/ Regional Grid Code	Descripti on	SUN2000 -8KTL-M2	SUN2000 -10KTL- M2	SUN2000 -12KTL- M2	SUN2000 -15KTL- M2	SUN2000 -17KTL- M2	SUN2000 -20KTL- M2
DENMARK -EN50549- DK1-LV230	Denmark power grid	Supported	Supported	Supported	Supported	Supported	Supported
DENMARK -EN50549- DK2-LV230	Denmark power grid	Supported	Supported	Supported	Supported	Supported	Supported
SWITZERL AND-NA/ EEA:2020- LV230	Switzerla nd	Supported	Supported	Supported	Supported	Supported	Supported
AUSTRALI A- AS4777_A- LV230	Australia	Supported	Supported	Supported	Supported	Supported	Supported
AUSTRALI A- AS4777_B- LV230	Australia	Supported	Supported	Supported	Supported	Supported	Supported
AUSTRALI A- AS4777_C- LV230	Australia	Supported	Supported	Supported	Supported	Supported	Supported
AUSTRALI A- AS4777_N Z-LV230	Australia	Supported	Supported	Supported	Supported	Supported	Supported
Pakistan	Pakistan	-	-	Supported	Supported	Supported	Supported

B Device Commissioning

Step 1 Access **Device Commissioning** screen.

Figure B-1 Method 1: before login (not connected to the Internet)



Figure B-2 Method 2: after login (connected to the Internet)

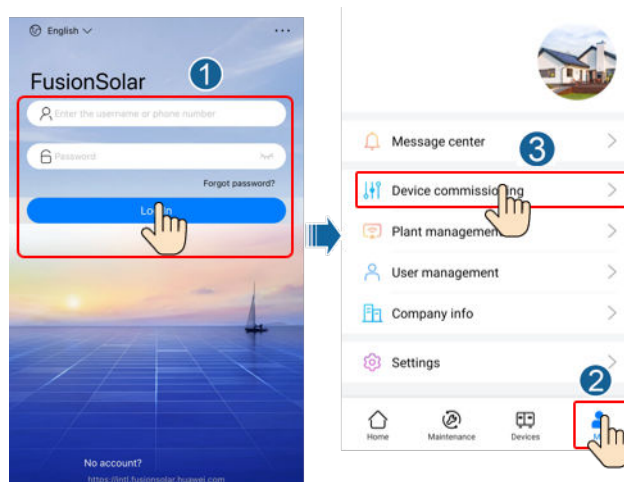

- Step 2** Connect to the solar inverter WLAN and log in to the device commissioning screen as the **installer** user.

NOTICE

- If the mobile phone is directly connected to the SUN2000, the visible distance between the SUN2000 and the mobile phone must be less than 3 m when a built-in antenna is used and less than 50 m when an external antenna is used to ensure the communication quality between the app and the SUN2000. The distances are for reference only and may vary with mobile phones and shielding conditions.
- When connecting the SUN2000 to the WLAN over a router, ensure that the mobile phone and SUN2000 are in the WLAN coverage of the router and the SUN2000 is connected to the router.
- The router supports WLAN (IEEE 802.11 b/g/n, 2.4 GHz) and the WLAN signal reaches the SUN2000.
- The WPA, WPA2, or WPA/WPA2 encryption mode is recommended for routers. Enterprise-level encryption is not supported (for example, public hotspots requiring authentication such as airport WLAN). WEP and WPA TKIP are not recommended because these two encryption modes have serious security defects. If the access fails in WEP mode, log in to the router and change the encryption mode of the router to WPA2 or WPA/WPA2.

 **NOTE**

- Obtain the initial password for connecting to the solar inverter WLAN from the label on the side of the solar inverter.
- Set the password at the first login. To ensure account security, change the password periodically and keep the new password in mind. Not changing the initial password may cause password disclosure. A password left unchanged for a long period of time may be stolen or cracked. If a password is lost, devices cannot be accessed. In these cases, the user is liable for any loss caused to the PV plant.
- When you access the **Device Commissioning** screen of the SUN2000 for the first time, you need to manually set the login password because the SUN2000 does not have an initial login password.

Figure B-3 Quick settings

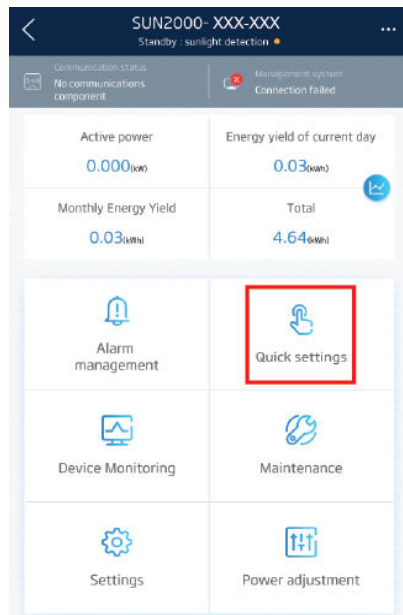

----End

C Resetting Password





- Step 1** Ensure that the SUN2000 connects to the AC and DC power supplies at the same time. Indicators  and  are steady green or blink at long intervals for more than 3 minutes.
- Step 2** Perform the following operations within 3 minutes:
1. Turn off the AC switch and set the DC switch at the bottom of the SUN2000 to OFF. Wait until all the LED indicators on the SUN2000 panel turn off.
 2. Turn on the AC switch and set the DC switch to ON. Ensure that the indicator  is blinking green at long intervals.
 3. Turn off the AC switch and set the DC switch to OFF. Wait until all LED indicators on the SUN2000 panel are off.
 4. Turn on the AC switch and set the DC switch to ON.
- Step 3** Reset the password within 10 minutes. (If no operation is performed within 10 minutes, all inverter parameters remain unchanged.)
1. Wait until the indicator  blinks green at long intervals.
 2. Obtain the initial WLAN hotspot name (SSID) and initial password (PSW) from the label on the side of the SUN2000 and connect to the app.
 3. On the login screen, set a new login password and log in to the app.

Figure C-1 Setting the password



Step 4 Set router and management system parameters to implement remote management.

- Setting router parameters

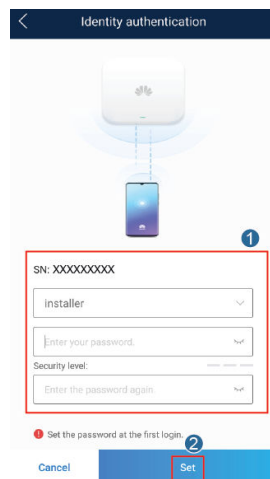
Log in to the FusionSolar app, choose **Device Commissioning > Settings > Communication configuration > Router connection settings**, and set router parameters.

Figure C-2 Setting router parameters

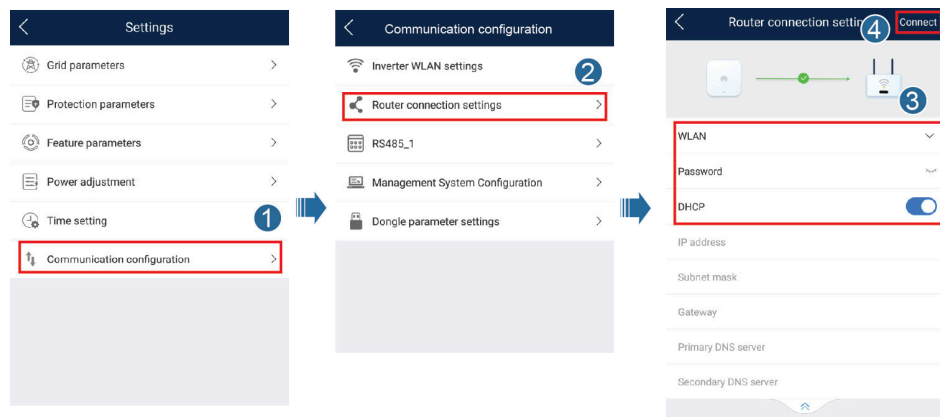

- Setting management system parameters

Log in to the FusionSolar app, choose **Device Commissioning > Settings > Communication configuration > Management System Configuration**, and set management system parameters.

Figure C-3 Setting management system parameters

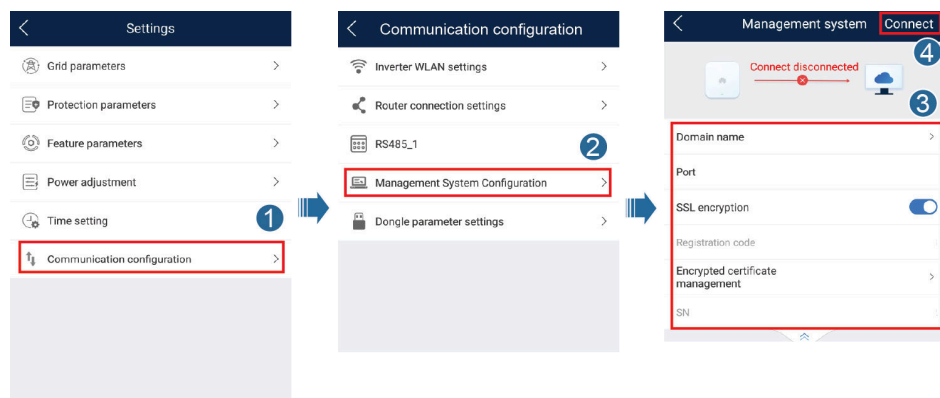

- (Optional) Resetting the WLAN password

Log in to the FusionSolar app, choose **Device Commissioning > Settings > Communication configuration > Inverter WLAN settings**, and reset the WLAN password.

Figure C-4 Resetting the WLAN password

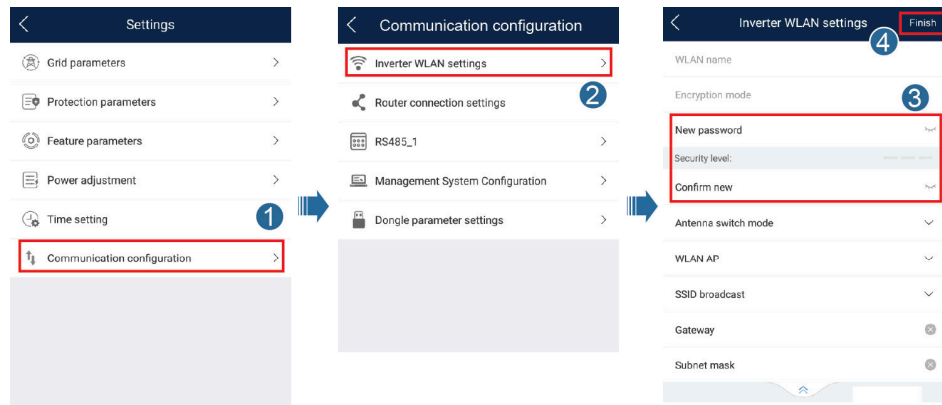

----End

D Rapid Shutdown

NOTE

- If optimizers are configured for some PV modules, the rapid shutdown function is not supported.
- You are advised to periodically check whether the rapid shutdown function is normal.

When all PV modules connected to the solar inverter are configured with optimizers, the PV system shuts down quickly and reduces the output voltage of the PV string to below 30 V within 30 seconds.

Perform the following step to trigger rapid shutdown:

- Method 1: To enable the rapid shutdown function, you need to connect the access switch to pins 13 and 15. The switch is closed by default. The rapid shutdown is triggered when the switch changes from closed to open.
- Method 2: Turn off the AC switch between the inverter and the power grid.
- Method 3: Set the DC switch at the bottom of the SUN2000 to OFF to trigger a rapid shutdown. The SUN2000 shuts down several minutes later. (Turning off all external switches on the DC side of the SUN2000 triggers a rapid shutdown, whereas turning off only some external switches will not trigger a rapid shutdown. PV strings may be energized.)

E Locating Insulation Resistance Faults

If the ground resistance of a PV string connected to a solar inverter is too low, the solar inverter generates a **Low Insulation Resistance** alarm.

The possible causes are as follows:

- A short circuit occurs between the PV array and the ground.
- The ambient air of the PV array is damp and the insulation between the PV array and the ground is poor.

To locate the fault, connect each PV string to a solar inverter, power on and check the solar inverter, and locate the fault based on the alarm information reported by the FusionSolar app. If a system is not configured with any optimizer, skip the corresponding operations. Perform the following steps to locate an insulation resistance fault.

NOTICE

If two or more ground insulation faults occur in a single PV string, the following method cannot locate the fault. You need to check the PV modules one by one.

- Step 1** The AC power supply is connected, and set the DC switch at the bottom of the solar inverter to OFF. If the solar inverter connects to batteries, wait for 1 minute, and turn off the battery switch and then the auxiliary power switch of the battery.
- Step 2** Connect each PV string to the solar inverter and set the DC switch to ON. If the solar inverter status is **Shutdown: Command**, choose **Device Commissioning > Maintenance > Inverter ON/OFF** on the app and send a startup command.
- Step 3** Log in to the FusionSolar app and choose **My > Device Commissioning**. On the **Device Commissioning** screen, connect and log in to the solar inverter, and access the **Alarm management** screen. Check whether the **Low Insulation Resistance** alarm is reported.
 - If the **Low Insulation Resistance** alarm is not reported one minute after the DC is supplied, choose **Device Commissioning > Maintenance > Inverter ON/OFF** on the app and send a shutdown command. Set the DC switch to OFF and go to **Step 2** to connect another PV string to the solar inverter for a check.

- If a **Low Insulation Resistance** alarm is still reported one minute after the DC is supplied, check the percentage for possible short-circuit positions on the **Alarm details** page and go to **Step 4**.

Figure E-1 Alarm details



NOTE

- The positive and negative terminals of a PV string are connected to the PV+ and PV- terminals of the solar inverter. The PV- terminal represents a possibility of 0% for the short-circuit position and the PV+ terminal represents a possibility of 100% for the short-circuit position. Other percentages indicate that the fault occurs on a PV module or cable in the PV string.
- Possible fault position = Total number of PV modules in a PV string x Percentage of possible short-circuit positions. For example, if a PV string consists of 14 PV modules and the percentage of the possible short-circuit position is 34%, the possible fault position is 4.76 (14 x 34%), indicating that the fault is located near PV module 4, including the previous and the next PV modules and the cables of PV module 4. The solar inverter has a detection precision of ± 1 PV module.

Figure E-2 Definition of the percentage of the short-circuit position

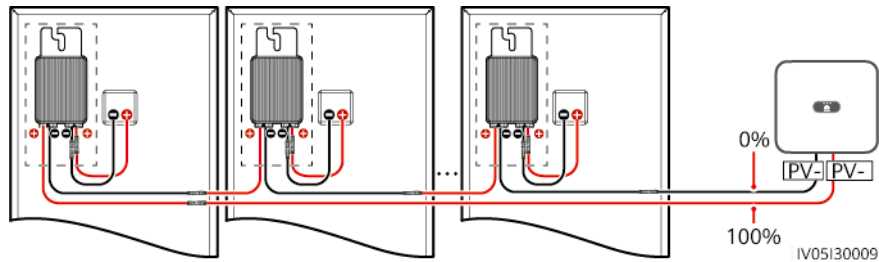

Step 4 Set the DC switch to OFF and check whether the connector or DC cable between the possible faulty PV modules and the corresponding optimizers, or those between the adjacent PV modules and the corresponding optimizers are damaged.

- If yes, replace the damaged connector or DC cable, set the DC switch to ON, and view the alarm information.
 - If the **Low Insulation Resistance** alarm is not reported one minute after the DC is supplied, the inspection on the PV string is complete. Choose **Device Commissioning > Maintenance > Inverter ON/OFF** on the app and send a shutdown command. Set the DC switch to OFF. Go to **Step 2** to check other PV strings. Then go to **Step 8**.
 - If the **Low Insulation Resistance** alarm is still reported one minute after the DC is supplied, go to **Step 5**.
- If not, go to **Step 5**.

- Step 5** Set the DC switch to OFF, disconnect the possible faulty PV modules and corresponding optimizers from the PV string, and connect a DC extension cable with an MC4 connector to the adjacent PV modules or optimizers. Set the DC switch to ON and view the alarm information.
- If the **Low Insulation Resistance** alarm is not reported one minute after the DC is supplied, the fault occurs on the disconnected PV module and optimizer. Choose **Device Commissioning > Maintenance > Inverter ON/OFF** on the app and send a shutdown command. Go to **Step 7**.
 - If the **Low Insulation Resistance** alarm is still reported one minute after the DC is supplied, the fault does not occur on the disconnected PV module or optimizer. Go to **Step 6**.
- Step 6** Set the DC switch to OFF, reconnect the removed PV module and optimizer, and repeat **Step 5** to check the adjacent PV modules and optimizers.
- Step 7** Determine the position of the ground insulation fault.
1. Disconnect the possible faulty PV module from the optimizer.
 2. Set the DC switch to OFF.
 3. Connect the possible faulty optimizer to the PV string.
 4. Set the DC switch to ON. If the solar inverter status is **Shutdown: Command**, choose **Device Commissioning > Maintenance > Inverter ON/OFF** on the app and send a startup command. Check whether the **Low Insulation Resistance** alarm is reported.
 - If the **Low Insulation Resistance** alarm is not reported one minute after the solar inverter is powered on, the PV module is faulty. Choose **Device Commissioning > Maintenance > Inverter ON/OFF** on the app and send a shutdown command.
 - If the **Low Insulation Resistance** alarm is still reported one minute after the solar inverter is powered on, the optimizer is faulty.
 5. Set the DC switch to OFF. Replace the faulty component to rectify the insulation resistance fault. Go to **Step 2** to check other PV strings. Then go to **Step 8**.
- Step 8** If the solar inverter connects to batteries, turn on the auxiliary power switch of the battery and then the battery switch. Set the DC switch to ON. If the solar inverter status is **Shutdown: Command**, choose **Device Commissioning > Maintenance > Inverter ON/OFF** on the app and send a startup command.

----End

F Acronyms and Abbreviations

A	
ACDU	alternating current distribution unit
AFCI	arc-fault circuit interrupter
L	
LED	light emitting diode
M	
MPP	maximum power point
MPPT	maximum power point tracking
P	
PV	photovoltaic
R	
RCD	residual current device
W	
WEEE	waste electrical and electronic equipment