



Installation Guide

Three Phase System with SetApp Configuration

For Europe and APAC

Version 1.2

Disclaimers

Important Notice

Copyright © SolarEdge Inc. All rights reserved.

No part of this document may be reproduced, stored in a retrieval system or transmitted, in any form or by any means, electronic, mechanical, photographic, magnetic or otherwise, without the prior written permission of SolarEdge Inc.

The material furnished in this document is believed to be accurate and reliable.

However, SolarEdge assumes no responsibility for the use of this material. SolarEdge reserves the right to make changes to the material at any time and without notice. You may refer to the SolarEdge web site (www.solaredge.com) for the most updated version.

All company and brand products and service names are trademarks or registered trademarks of their respective holders.

Patent marking notice: see <http://www.solaredge.com/patent>

The general terms and conditions of delivery of SolarEdge shall apply.

The content of these documents is continually reviewed and amended, where necessary. However, discrepancies cannot be excluded. No guarantee is made for the completeness of these documents.

The images contained in this document are for illustrative purposes only and may vary depending on product models.

Emission Compliance

This equipment has been tested and found to comply with the limits applied by the local regulations. These limits are designed to provide reasonable protection against harmful interference in a residential installation. This equipment generates, uses and can radiate radio frequency energy and, if not installed and used in accordance with the instructions, may cause harmful interference to radio communications. However, there is no guarantee that interference will not occur in a particular installation. If this equipment does cause harmful interference to radio or television reception, which can be determined by turning the equipment off and on, you are encouraged to try to correct the interference by one or more of the following measures:

- Reorient or relocate the receiving antenna.
- Increase the separation between the equipment and the receiver.
- Connect the equipment into an outlet on a circuit different from that to which the receiver is connected.
- Consult the dealer or an experienced radio/TV technician for help.

Changes or modifications not expressly approved by the party responsible for compliance may void the user's authority to operate the equipment.

Support and Contact Information

If you have technical problems concerning SolarEdge products, please contact us:

Country	Phone	E-Mail
Australia (+61)	1800 465 567	support@solaredge.net.au
APAC (Asia Pacific)(+972)	073 240 3118	support-asia@solaredge.com
Belgium (+32)	0800-76633	support@solaredge.be
China (+86)	21 6212 5536	support_china@solaredge.com
DACH & Rest of Europe (+49)	089 454 59730	support@solaredge.de
France (+33)	0800 917410	support@solaredge.fr
Italy (+39)	0422 053700	support@solaredge.it
Japan (+81)	03 6262 1223	support@solaredge.jp
Netherlands (+31)	0800-7105	support@solaredge.nl
New Zealand (+64)	0800 144 875	support@solaredge.net.au
Republic of Ireland (+353)	1800-901-575	support-uk@solaredge.com
United Kingdom (+44)	0800 028 1183	
US & Canada (+1)	510 498 3200	ussupport@solaredge.com
Greece (+49)	89 454 59730	support@solaredge.com
Israel (+972)	073 240 3122	
Middle East & Africa (+972)	073 240 3118	
South Africa (+27)	0800 982 659	
Turkey (+90)	216 706 1929	
Worldwide (+972)	073 240 3118	

Before contact, make sure to have the following information at hand:

- Model and serial number of the product in question.
- The error indicated on the Inverter SetApp mobile application or on the monitoring platform or by the LEDs, if there is such an indication.
- System configuration information, including the type and number of modules connected and the number and length of strings.
- The communication method to the SolarEdge server, if the site is connected.
- The inverter software version as appears in the status screen.

Revision History

Version 1.2 (Feb 2019)

- Added appendix 'Determining the Circuit Breaker Size' and paragraph referencing to it, in the 'Grid Connection Guidelines' section.
- Updated guidelines for use of extension cables in power optimizer installation
- Torque for plastic cover screws 10.3 N*m/ 7.5 lb-ft.
- In Specifications:
 - Addition of footnote for MC4 inputs: Connection of additional strings in parallel to a single input is allowed as long as the cumulative current does not exceed 45A.
 - Removed the 'Recommended circuit breaker/ fuse size to use at the grid connection point' table.

Version 1.0 (Aug. 2018)

Initial release

Contents

Disclaimers	1
Important Notice	1
Emission Compliance	2
Support and Contact Information	3
Revision History	4
HANDLING AND SAFETY INSTRUCTIONS	7
Safety Symbols Information	7
IMPORTANT SAFETY INSTRUCTIONS	8
Chapter 1: Introducing the SolarEdge Power Harvesting System	10
Power Optimiser	10
Inverter	11
Monitoring Platform	11
Installation Procedure	11
Installation Equipment List	11
Inverter Transport and Storage	12
Chapter 2: Installing the Power Optimizers	13
Safety	13
Installation Guidelines	14
Step 1: Mounting the Power Optimizers	17
Step 2: Connecting a PV Module to a Power Optimiser	17
Step 3: Connecting Power Optimizers in Strings	18
Step 4: Verifying Proper Power Optimiser Connection	19
Chapter 3: Installing the Inverter	20
Inverter Package Contents	20
Identifying the Inverter	20
Inverter Interfaces	20
Mounting the Inverter	25
Chapter 4: Connecting the AC and the Strings to the Inverter	30
Grid Connection Guidelines	30
Connecting the AC Grid to the Inverter	31
Connecting the Strings to the Inverter	33
Selecting a Residual Current Device (RCD)	33
Chapter 5: Activating, Commissioning and Configuring the System Using the Inverter SetApp	35
Step 1: Activating the Installation	35
Step 2: Commissioning and Configuring the Installation	36
Step 3: Verifying Proper Activation and Commissioning	40
Viewing System Status	40

Reporting and Monitoring Installation Data	46
Chapter 6: Setting Up Communication	49
Communication Options	49
Communication Connectors	51
Removing the Inverter Cover	52
Creating an Ethernet (LAN) Connection	52
Creating an RS485 Bus Connection	56
Verifying the Connection	60
Appendix A: Errors and Troubleshooting	62
Identifying Errors	62
Troubleshooting Communication	64
Power Optimizer Troubleshooting	65
Appendix B: Mechanical Specifications	67
Appendix C: Connecting the AC and DC Strings to the DC Safety Unit	68
Connecting the AC Grid to the Inverter	69
Connecting the Strings to the DC Safety Unit	70
Appendix D: SafeDC™	73
Appendix E: External Fan Maintenance and Replacement	74
Fan Maintenance	74
External Fan Replacement	74
Appendix F: Replacing and Adding System Components	77
Replacing an Inverter	77
Replacing the DC Safety Unit	78
Adding, Removing, or Replacing Power Optimizers	81
Appendix G: Determining the Circuit Breaker Size	82
Revision History	82
Introduction	82
Using Transformers in Commercial Three Phase Inverter Installations	82
Determining the Size of an Inverter Circuit Breaker	84
Technical Specifications - Three Phase Inverters (Europe & APAC)	86

HANDLING AND SAFETY INSTRUCTIONS

During installation, testing and inspection, adherence to all the handling and safety instructions is mandatory. **Failure to do so may result in injury or loss of life and damage to the equipment.**

Safety Symbols Information

The following safety symbols are used in this document. Familiarize yourself with the symbols and their meaning before installing or operating the system.

WARNING!



Denotes a hazard. It calls attention to a procedure that, if not correctly performed or adhered to, could result in **injury or loss of life**. Do not proceed beyond a warning note until the indicated conditions are fully understood and met.

CAUTION!



Denotes a hazard. It calls attention to a procedure that, if not correctly performed or adhered to, could result in **damage or destruction of the product**. Do not proceed beyond a caution sign until the indicated conditions are fully understood and met.

NOTE



Denotes additional information about the current subject.

IMPORTANT SAFETY FEATURE



Denotes information about safety issues.

Disposal requirements under the Waste Electrical and Electronic Equipment (WEEE) regulations:



NOTE

Discard this product according to local regulations or send it back to SolarEdge.

IMPORTANT SAFETY INSTRUCTIONS

SAVE THESE INSTRUCTIONS

WARNING!



The inverter cover must be opened only after switching the inverter ON/OFF/P switch located at the bottom of the inverter to OFF. This disables the DC voltage inside the inverter. Wait five minutes before opening the cover. Otherwise, there is a risk of electric shock from energy stored in the capacitors.



P = Program/Pair
1 = ON
0 = OFF

WARNING!



Before operating the inverter, ensure that the inverter AC power cable and wall outlet are grounded properly. This product must be connected to a grounded, metal, permanent wiring system, or an equipment-grounding conductor must be run with the circuit conductors and connected to the equipment grounding terminal or lead on the product.

WARNING!



Opening the inverter and repairing or testing under power must be performed only by qualified service personnel familiar with this inverter.

WARNING!



Do not touch the PV panels or any rail system connected when the inverter switch is ON, unless grounded.

WARNING!

SafeDC complies with IEC60947-3 when installing the system with a worst case SafeDC voltage (under fault conditions) < 120V.



The worst case voltage is defined as: $V_{oc,max} + (\text{String Length} - 1) * 1V$, where:

- $V_{oc,max}$ = Maximum V_{oc} (at lowest temperature) of the PV module in the string (for a string with multiple module models, use the max value)
- String Length = number of power optimizers in the string

CAUTION!





This unit must be operated according to the technical specification datasheet provided with the unit.



CAUTION!



HEAVY OBJECT. To avoid muscle strain or back injury, use proper lifting techniques, and if required - a lifting aid.

 **NOTE**
 The inverter is IP65 rated . Unused conduit openings and glands should be sealed with appropriate seals.







 **NOTE**
 Use PV modules rated according to IEC 61730 class A.

 **NOTE**
 The symbol  appears at grounding points on the SolarEdge equipment. This symbol is also used in this manual.

NOTE
 A SolarEdge inverter may be installed in a site with a generator, however must not operate at the same time as the generator.

 Operating an inverter and a generator simultaneously will void the warranty. SolarEdge requires installing a physical or electronic interlock, which will prevent the generator and inverter from operating simultaneously. Interlock procurement, installation, maintenance and support are the responsibility of the installer. Damage to the inverter due to incorrect interlock installation or use of an interlock that is incompatible with the SolarEdge system will render the SolarEdge warranty invalid.

NOTE
 The following warning symbols appear on the inverter warning label:

-   Risk of electric shock
-   Risk of electric shock from energy stored in the capacitor. Do not remove cover until 5 minutes after disconnecting all sources of supply.
-   Hot surface – To reduce the risk of burns, do not touch.

Chapter 1: Introducing the SolarEdge Power Harvesting System

The SolarEdge power harvesting solution maximizes the power output from any type of solar Photovoltaic (PV) installation while reducing the average cost per watt. The following sections describe each of the system's components.

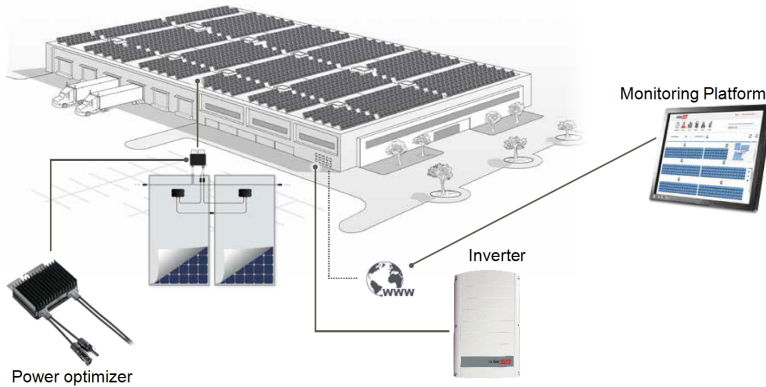

Figure 1: The SolarEdge power harvesting system components

Power Optimiser

The power optimizers are DC-DC converters connected to PV modules in order to maximize power harvesting by performing independent Maximum Power Point Tracking (MPPT) at the module level.

The power optimizers regulate the string voltage at a constant level, regardless of string length and environmental conditions.

The power optimizers include a safety voltage function that automatically reduces the output of each power optimizer to 1 Vdc in the following cases:

- During fault conditions
- The power optimizers are disconnected from the inverter
- The inverter ON/OFF switch is turned OFF
- The safety switch on the DC Safety Unit is turned OFF
- The inverter AC breaker is turned OFF

Each power optimizer also transmits module performance data over the DC power line to the inverter.

Two types of power optimizers are available:

- Module Add-on power optimizer – connected to one or more modules
- Smart modules - the power optimizer is embedded into a module

Inverter

The inverter efficiently converts DC power from the modules into AC power that can be fed into the main AC service of the site and from there to the grid. The inverter also receives the monitoring data from each power optimizer and transmits it to a central server (the monitoring platform; requires Internet connection).

Some inverters are available with an optional DC Safety Unit. The DC Safety Unit has a manually operated switch for disconnecting the DC power of a SolarEdge system.

The DC Safety Unit is located below the inverter and is connected to the inverter with AC and DC wires.

Monitoring Platform

The monitoring platform enables monitoring the technical and financial performance of one or more SolarEdge sites. It provides past and present information on the system performance both at the system and module levels.

Installation Procedure

The following is the procedure for installing and setting up a new SolarEdge site. Many of these also apply to modification of an existing site.

1. [Connecting Power Optimizers in Strings](#), page 18.
2. [Recording power optimizer serial numbers \(optional\)](#), page 47.
3. [Mounting the inverter](#), Page 25.
4. [Connecting the AC and the Strings to the Inverter](#), page 31, or [Connecting the AC and the String to the DC Safety Unit](#), page 68.
5. [Commissioning and activating the installation](#), page 35.
6. [Connecting the inverter to the monitoring platform](#), page 48.

Installation Equipment List

Standard tools can be used during the installation of the SolarEdge system. The following is a recommendation of the equipment needed for installation:

- Allen screwdriver for 5mm screw type for the inverter cover, DC Safety Unit cover (if applicable), and inverter side screws

- Allen screwdriver for M5/M6/M8 screw types
- Standard flat-head screwdrivers set
- Non-contact voltage detector
- Cordless drill (with a torque clutch) or screwdriver and bits suitable for the surface on which the inverter and optimizers will be installed. Use of an impact driver is *not* allowed.
- Appropriate mounting hardware (for example: stainless bolts, nuts, and washers) for attaching:
 - the mounting brackets to the mounting surface
 - the power optimizer to the racking (not required for smart modules)
- MC4 crimper
- Wire cutters
- Wire strippers
- Voltmeter

For installing the communication options, you may also need the following:

- For Ethernet:
 - CAT5/6 twisted pair Ethernet cable with RJ45 connector.
 - If using a CAT5/6 cable spool: RJ45 plug and RJ45 crimper
- For RS485:
 - Four- or six-wire shielded twisted pair cable.
 - Watchmaker precision screwdriver set

Inverter Transport and Storage

Transport the inverter in its original packaging, facing up and without exposing it to unnecessary shocks. If the original package is no longer available, use a similar box that can withstand the weight of the inverter (refer to the inverter weight in the specification datasheet provided with the unit), has a handle system and can be closed fully.

Store the inverter in a dry place where ambient temperatures are -25°C to +65°C / -13°F to 149°F.

Chapter 2: Installing the Power Optimizers

Safety

The following notes and warnings apply when installing the power optimizers. Some of the following may not be applicable to smart modules:

WARNING!

When modifying an existing installation, turn OFF the inverter ON/OFF switch, the Connection Unit and the AC circuit breaker on the main AC distribution panel.

CAUTION!

Power optimizers are IP68/NEMA6P rated. Choose a mounting location where optimizers will not be submerged in water.

CAUTION!

This unit must be operated according to the operating specifications provided with the unit.

CAUTION!

Cutting the power optimizer input or output cable connector is prohibited and will void the warranty.

CAUTION!

All PV modules must be connected to a power optimizer.

CAUTION!

If you intend to mount the optimizers directly to the module or module frame, first consult the module manufacturer for guidance regarding the mounting location and the impact, if any, on module warranty. Drilling holes in the module frame should be done according to the module manufacturer instructions.

CAUTION!

Installing a SolarEdge system without ensuring compatibility of the module connectors with the optimizer connectors may be unsafe and could cause functionality problems such as ground faults, resulting in inverter shut down. To ensure mechanical compatibility of the power optimizers' connectors with the PV modules' connectors to which they are connected:

- Use identical connectors from the same manufacturer and of the same type on both the power optimizers and on the modules; or
- Verify that the connectors are compatible in the following way:
 - The module connector manufacturer should explicitly verify compatibility with the SolarEdge optimizer connector; and
 - A third-party test report by one of the listed external labs (TUV, VDE, Bureau Veritas UL, CSA, InterTek) should be obtained, verifying the compatibility of the connectors.



For more information, refer to

<https://www.solaredge.com/sites/default/files/optimizer-input-connector-compatibility.pdf>

**IMPORTANT SAFETY FEATURE**

Modules with SolarEdge power optimizers are safe. They carry only a low safety voltage before the inverter is turned ON. As long as the power optimizers are not connected to the inverter or the inverter is turned OFF, each power optimizer will output a safe voltage of 1V.

Installation Guidelines

- The minimum and maximum string length guidelines are stated in the power optimizer datasheets. Refer to the Designer for string length verification. The Designer is available on the SolarEdge website at <https://www.solaredge.com/products/installer-tools/designer#/>.
- Frame-mounted power optimizers are mounted directly on the module frame, regardless of racking system (rail-less or with rails). For installation of frame-mounted power optimizers, refer to http://www.solaredge.com/sites/default/files/installing_frame_mounted_power_optimizers.pdf.



- The steps in this chapter refer to module add-on power optimizers. For smart modules, start from *Step 3: Connecting Power Optimizers in Strings* on page 18. Also refer to the documentation supplied with the smart modules.
- The power optimizer can be placed in any orientation.
- If connecting more modules than optimizer inputs in parallel, use a branch cable. Some commercial power optimizer models have a dual input.
- Position the power optimizer close enough to its module so that their cables can be connected.
- Make sure to use power optimizers that have the required output conductor length:
 - Do not use extension cables between a module and a power optimizer, between two modules connected to the same optimizer, or between two optimizers other than in the cases specified below.
 - You can use extension cables between power optimizers only from row to row, around obstacles within a row, and from the end of the string to the inverter, as long as the maximum distance is not exceeded.

NOTE

- The total conductor length of the string (excluding power optimizers’ conductors; including home runs and necessary extensions between optimizers) should not exceed the following:



Inverter model	Total conductor length (from DC+ to DC- of the inverter)
Three phase up to SE25K	1000 ft. /300 m
Three phase SE25K and above	2300 ft./ 700 m

- Use at least 11 AWG/ 4 mm² DC cables.
- Completely shaded modules may cause their power optimizers to temporarily shut down. This will not affect the performance of the other power optimizers in the string, as long as the minimum number of unshaded power optimizers connected in a string of modules is met. If under typical conditions fewer than

the minimum optimizers are connected to unshaded modules, add more optimizers to the string.

- To allow for heat dissipation, maintain a 2.5 cm / 1" clearance distance between the power optimizer and other surfaces, on all sides except the mounting bracket side.

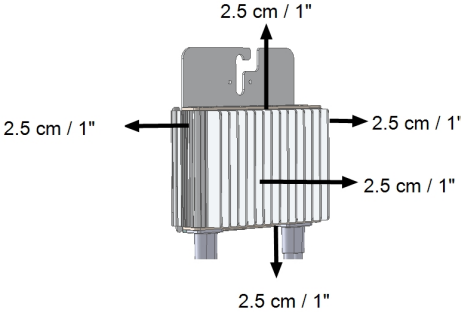

Figure 2: Power optimizer clearance

- When installing modules in a confined space, for example, if installing Building-integrated photovoltaic (BIPV) modules, ventilation measures may be needed to ensure the power optimizers are not be exposed to temperatures outside their specifications.



NOTE

The images contained herein are for illustrative purposes only and may vary depending on product models.

Step 1: Mounting the Power Optimizers

For each of the power optimizers⁽¹⁾:

1. Determine the power optimizer mounting location and use the power optimizer mounting brackets to attach the power optimizer to the support structure. It is recommended to mount the power optimizer in a location protected from direct sunlight. For frame-mounted power optimizers follow the instructions supplied with the optimizers, or refer to https://www.solaredge.com/sites/default/files/installing_frame_mounted_power_optimizers.pdf. 
2. If required, mark the mounting hole locations and drill the hole.

CAUTION!



Drilling vibrations may damage the power optimizer and will void the warranty. Use a torque wrench or an electric drill with adjustable clutch that meets the mounting torque requirements. *Do not* use impact drivers for mounting the power optimizer.

Do not drill through the power optimizer or through the mounting holes.

3. Attach each power optimizer to the rack using M6 (1/4") stainless steel bolts, nuts and washers or other appropriate mounting hardware. Apply torque of 9-10 N*m / 6.5-7 lb*ft.
4. Verify that each power optimizer is securely attached to the module support structure.
5. Record power optimizer serial numbers and locations, as described in *Reporting and Monitoring Installation Data* on page 46.

Step 2: Connecting a PV Module to a Power Optimiser



NOTE

Images are for illustration purposes only. Refer to the label on the product to identify the plus and minus input and output connectors.

For each of the power optimizers:

- Connect the Plus (+) output connector of the module to the Plus (+) input connector of the power optimizer.

⁽¹⁾Not applicable to smart modules.

- Connect the Minus (-) output connector of the module to the Minus (-) input connector of the power optimizer.

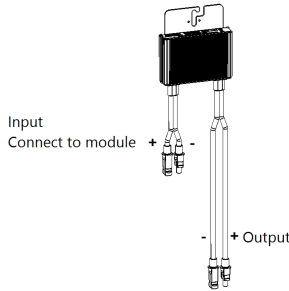

Figure 3: Power optimizer connectors

Step 3: Connecting Power Optimizers in Strings

You can construct parallel strings of unequal length, that is, the number of power optimizers in each string does not have to be the same. The minimum and maximum string lengths are specified in the power optimizer datasheets. Refer to the [Designer](#) for string length verification.



1. Connect the Minus (-) output connector of the string’s first power optimizer to the Plus (+) output connector of the string’s second power optimizer.
2. Connect the rest of the power optimizers in the string in the same manner.

WARNING!



If using a dual-input power optimizer and some inputs are not used, seal the unused input connectors with the supplied pair of seals.

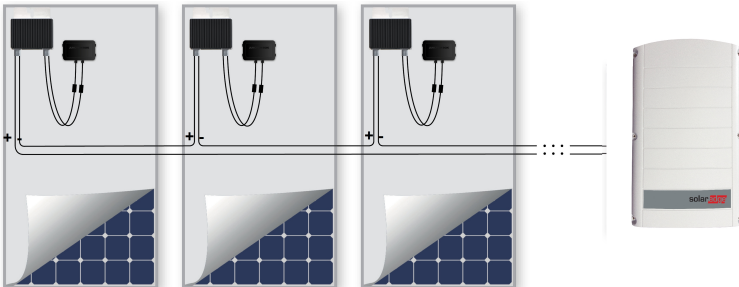

Figure 4: Power optimizers connected in series

3. If you intend to monitor the installation, using the monitoring platform, record the physical location of each power optimizer, as described in *Creating Logical and Physical Layout using Installation Information* on page 47.

Step 4: Verifying Proper Power Optimiser Connection

When a module is connected to a power optimizer, the power optimizer outputs a safe voltage of 1V ($\pm 0.1V$). Therefore, the total string voltage should equal 1V times the number of power optimizers connected in series in the string. For example, if 10 power optimizers are connected in a string, then 10V should be produced.

Make sure the PV modules are exposed to sunlight during this process. The power optimizer will only turn ON if the PV module provides at least 2W.

In SolarEdge systems, due to the introduction of poweroptimizers between the PV modules and the inverter, the short circuit current I_{SC} and the open circuit voltage V_{OC} hold different meanings from those in traditional systems.

For more information about the SolarEdge system's string voltage and current, refer to the *V_{OC} and I_{SC} in SolarEdge Systems Technical Note*, available on the SolarEdge website at:

https://www.solaredge.com/sites/default/files/isc_and_voc_in_solaredge_sytems_technical_note.pdf.



→ To verify proper power optimizer connection:

Measure the voltage of each string individually before connecting it to the other strings or to the inverter. Verify correct polarity by measuring the string polarity with a voltmeter. Use a voltmeter with at least 0.1V measurement accuracy.



NOTE

Since the inverter is not yet operating, you may measure the string voltage and verify correct polarity on the DC wires inside the DC Safety Unit.

For troubleshooting power optimizer operation problems, refer to *Power Optimizer Troubleshooting* on page 65.

Chapter 3: Installing the Inverter

Install the inverter either before or after the modules and power optimizers have been installed.

CAUTION!



Do not rest the connectors at the bottom of the inverter on the ground, as it may damage them. To rest the inverter on the ground, lay it on its back, front or side.

Inverter Package Contents

- One inverter with DC Safety Unit
- One mounting bracket
- Two Allen screws for fastening the inverter to the mounting bracket
- Installation guide
- Optional (for wireless communication to monitoring platform) - RF antenna and mounting bracket
- AC ferrite bead kit

Identifying the Inverter

Refer to the sticker on the inverter that specifies its **Serial Number** and its **Electrical Ratings**. Provide the serial number when contacting SolarEdge support. The serial number is also required when opening a new site in the monitoring platform.

Inverter Interfaces

The following figure shows the inverter connectors and components, located at the bottom of the inverter.

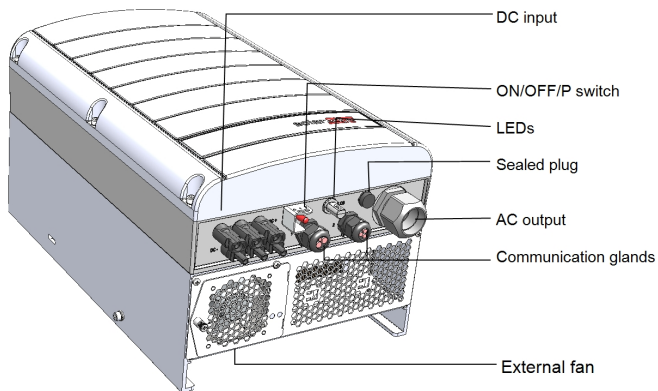

Figure 5: Inverter Interfaces

- **AC output:** AC output gland, AC cable external gauge, M32 (15-21mm diameter) for connection to the grid
- **DC input:** MC4 connector ,for connection of the PV installation
- **Two communication glands:** for connection of inverter communication options. Each gland has three openings. Refer to *Setting Up Communication* on page 49 for more information.
- **ON/OFF/P Switch:**



P = Program/Pair
 1 = ON
 0 = OFF

Figure 6: ON/OFF/P switch

- **ON (1)** - Turning this switch ON (after optimizer pairing) starts the operation of the power optimizers, enables power production and allows the inverter to begin exporting power to the utility grid.
- **OFF (0)** - Turning this switch OFF reduces the power optimizer voltage to a low safety voltage and inhibits exportation of power. When this switch is OFF, the control circuitry remains powered up.
- **P** - Moving and releasing the switch allows viewing system information

via the LEDs and on the SolarEdge SetApp mobile application screen, and performing the following functions:

P Position duration	Function	Comments
Switch moved to P for less than 5 seconds , then released.	<ul style="list-style-type: none"> Displays (via LEDs) production information for 5 seconds, or error type indications (if exist) for 5 seconds. Activates the Wi-Fi access point for connecting to the SetApp 	<p>While the switch is in P, all LEDs are ON.</p> <p>When the switch is released all LEDs turn OFF for 0.5 sec and then display the production or error indication.</p>
Switch moved to P for more than 5 seconds , then released.	Starts pairing	Pairing is indicated by all 3 LEDs blinking simultaneously.

- **LEDs:** three LEDs indicate, by color and state (on/ off/ blinking⁽¹⁾/ flickering⁽²⁾/alternating⁽³⁾), different system information, such as errors or performance indications. For more information, refer to <https://www.solaredge.com/leds>.

The main LED indications are:

- Blue ON - the inverter is communicating with the monitoring platform
- Green ON - the system is producing



(1)Blinking = Turns ON and OFF for the same duration

(2)Flickering = Turns ON for 100 mS and turns OFF for 5 seconds

(3)Alternating = alternate LED flashes

- Green blinking - AC is connected but the system is not producing
- Red ON - system error

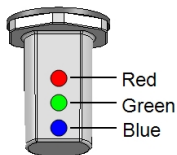

Figure 7: LEDs

The following table describes system performance information by LED color and ON/OFF/P switch position.

Indication	ON/ OFF/ P switch position	LED color			Comment
		Red	Green	Blue	
Power optimizers not paired	ON (1)	OFF	Blinking	<ul style="list-style-type: none"> • S_OK: ON • No S_OK: OFF 	S_OK: ON communication with the monitoring platform is established.
Pairing		Blinking	Blinking	Blinking	
Wake-up/ Grid Monitoring		OFF	Blinking	Blinking	
System Producing		OFF	ON	<ul style="list-style-type: none"> • S_OK: ON • No S_OK: OFF 	
Night mode (no production)		OFF	Flickering	<ul style="list-style-type: none"> • S_OK: ON • No S_OK: OFF 	

Indication	ON/ OFF/ P switch position	LED color			Comment
		Red	Green	Blue	
Inverter is OFF (Safe DC)	OFF (0)	OFF	Blinking	<ul style="list-style-type: none"> S_OK: ON No S_OK: OFF 	
Inverter is OFF (DC not safe)		Blinking	Blinking	<ul style="list-style-type: none"> S_OK: ON No S_OK: OFF 	
Inverter configuration or reboot	ON / P	ON	ON	ON	
Inverter firmware upgrade	ON / P	Alternating	Alternating	Alternating	The upgrade process can take up to 5 minutes
Error	Any	ON	ON/ OFF/ Blinking/ Flickering	ON/ OFF / Blinking	Refer to <i>Errors and Troubleshooting</i> on page 62

The following table describes production percentage of AC information by LED color and ON/OFF/P switch position.

Indication	ON/ OFF/ P switch position	LED color			Comment
		Red	Green	Blue	
Percentage of AC Production: 0 %	ON (1)	OFF	OFF	OFF	This indicates power production as percentage of rated peak AC output power
Percentage of AC Production: 0 - 33 %		OFF	ON	OFF	
Percentage of AC Production: 33 - 66 %		OFF	OFF	ON	
Percentage of AC Production: 66 - 100 %		OFF	ON	ON	

- **DC Safety Unit** (if applicable), including:
 - **ON/OFF switch:** connects and disconnects the DC power of the system
 - **AC output:** Cable gland for connection to the grid
 - **DC input:** Cable glands or MC4 connectors for connection of the PV installation
 - **Secondary grounding** (optional): Cable gland for grounding

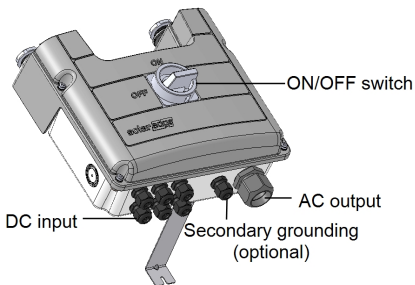

Figure 8: DC Safety Unit

NOTE

When the DC Safety Unit is OFF (for example during maintenance) it may be locked to prevent a safety hazard:



1. Move the switch to the Lock position.
2. Insert the lock through the knob opening and lock.



Lock here

Mounting the Inverter

The inverter is typically mounted vertically, and the instructions in this section are applicable for vertical installation. Some three phase inverter models can be installed horizontally (above 10° tilt) as well as vertically, and at any tilt over 10° up to 90°. For information and instructions for horizontal mounting refer to



http://www.solaredge.com/sites/default/files/application_note_horizontal_mounting_of_three_phase_inverters.pdf.

The inverter is supplied with a mounting bracket.

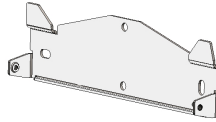

Figure 9: Mounting bracket

NOTE

Make sure the mounting surface or structure can support the weight of the inverter and bracket, and make sure that it spans the width of the bracket.

CAUTION!

HEAVY OBJECT. To avoid muscle strain or back injury, use proper lifting techniques, and if required - a lifting aid.

CAUTION!

SolarEdge inverters and power optimizers can be installed at a minimum distance of 50 m/ 164 ft from the shoreline of an ocean or other saline environment, as long as there are no direct salt water splashes on the inverter or power optimizer.

1. Determine the inverter mounting location, on a wall, stud framing or pole. It is recommended to mount the inverter in a location protected from direct sunlight.
2. To allow proper heat dissipation, maintain the following minimum clearance areas between the inverter and other objects:
 - If installing a single inverter:
 - At least 20 cm (8") from the top and bottom of the inverter; if installing an inverter with a DC Safety Unit, make sure to leave sufficient clearance for cable entry.
 - 10 cm (4") from the right and left of the inverter. For easy access to the fans, a larger clearance is recommended.
 - If installing multiple inverters:
 - When installing inverters one above the other, leave at least 40 cm (16") between inverters. If installing an inverter with a DC Safety Unit, leave 20 cm (8") between the top of an inverter and the bottom of the DC Safety Unit).
 - When installing inverters side by side, follow these clearance specifications:

Location	Indoor Installation	Outdoor Installation
Locations where the annual average high temperature ⁽¹⁾ is below 25°C / 77°F	20 cm / 8" between inverters	5 cm / 2" between inverters (if inverters are also installed one above the other, maintain the indoor installation clearance)
Locations where the annual average high temperature ¹ is above 25°C / 77°F	40 cm / 16" between inverters	

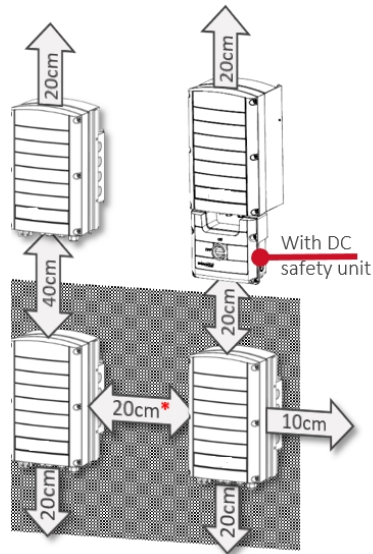

Figure 10: Clearance

(1)Annual average high temperature – the average of the 12 monthly average highs, for example:

Average High Temperature												Years on Record: 20	
C	ANNUAL	JAN	FEB	MAR	APR	MAY	JUN	JUL	AUG	SEP	OCT	NOV	DEC
	21.5	11.8	12.6	15.4	21.5	25.3	27.6	29	29.4	28.2	24.7	18.8	14

Refer to <http://www.weatherbase.com/> to find the value in your location.

3. Position the mounting bracket against the wall/pole and mark the drilling hole locations (refer to *Mechanical Specifications* on page 67 for inverter and mounting bracket dimensions):
 - Ensure that the flat edge of the bracket is at the bottom, as in *Figure 11*.
 - Use at least two bracket holes. Additional holes can be used to fix the bracket. Determine which and how many holes to use according to mounting surface type and material.
4. Drill the holes and mount the bracket. Verify that the bracket is firmly attached to the mounting surface.

NOTE

When mounting an inverter on an uneven surface, you may use spacers/washers behind the top mounting hole of the bracket. Depending on the angle, use the appropriate size and number of spacers so that the bracket is perpendicular to the ground. Recommended: a stainless steel 3/4" long screw, with a 1/4" socket button head, two jam nuts and three washers.

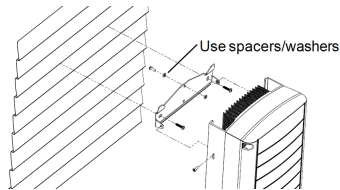

5. Hang the inverter on the bracket (see *Figure 17*): Lift the inverter from the sides, or hold it at the top and bottom of the inverter to lift the unit into place. Do not lift holding the Connection Unit/DC Safety Unit as it may be damaged.
6. Align the two indentations in the inverter enclosure with the two triangular mounting tabs of the bracket, and lower the inverter until it rests on the bracket evenly.

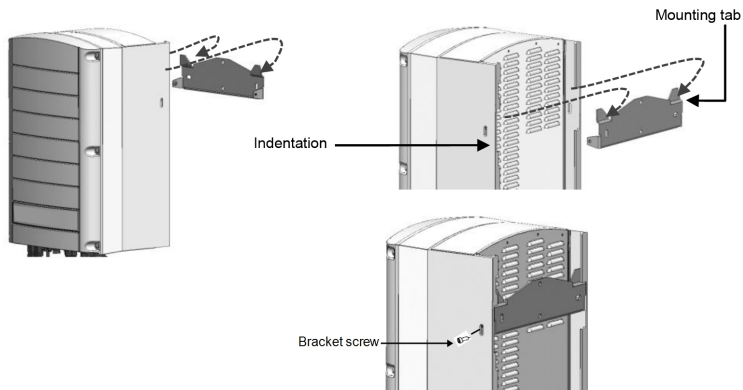

Figure 11: Hanging the inverter on the bracket

7. Secure the Connection Unit bracket to the wall:
8. For inverters with Connection Unit - secure the Connection Unit bracket to the wall:
 - Mark the location of the bracket screw for the DC Safety Unit and drill the hole.
 - Fasten the bracket using a standard bolt.
 - Verify that the bracket is firmly attached to the mounting surface.

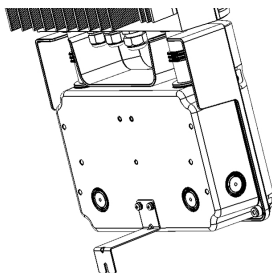

Figure 12: DC Safety Unit bracket

9. Insert the two supplied screws through the outer heat sink fin on both sides of the inverter and into the bracket (see *Figure 11*). Tighten the screws with a torque of 4.0 N*m / 2.9 lb.*ft.

Chapter 4: Connecting the AC and the Strings to the Inverter

This chapter describes how to connect the inverter to the AC grid, and to the strings of modules with power optimizers.

If using an inverter with a DC Safety Unit, refer to the instructions in *Connecting the AC and DC Strings to the DC Safety Unit* on page 68.

Refer to the technical specifications provided with the inverter.

Grid Connection Guidelines

- In most countries, three phase inverters require neutral connection at all times. In some countries, the three phase inverters can be connected to delta grids; in other cases, multiple single phase inverters can be used.

Prior to system installation, refer to:

- Three Phase Inverters for Delta Grids application note at https://www.solaredge.com/sites/default/files/se_three_phase_inverters_for_delta_grids.pdf



- Supported Countries application note to confirm compatibility at http://www.solaredge.com/sites/default/files/se_inverters_supported_countries.pdf; installing without confirmation may void the inverter warranty.



- For more wiring information refer to the *SolarEdge Recommended AC Wiring Application Note*, available on the SolarEdge website at <http://www.solaredge.com/files/pdfs/application-note-recommended-wiring.pdf>.
- For recommended circuit breaker size per model refer to *Determining the Circuit Breaker Size* on page 82



Connecting the AC Grid to the Inverter

Use a five-wire cable for three phase connection. The maximum wire size for the input terminal blocks is 16mm².

1. Turn OFF the AC circuit breaker.
2. Open the inverter cover: Release the six Allen screws and carefully move the cover horizontally before lowering it.

CAUTION!



When removing the cover, make sure not to damage internal components. SolarEdge will not be held responsible for any components damaged as a result of incautious cover removal.

3. Strip 58 mm / 2.32" of the external cable insulation and strip 8 mm / 0.32" of the internal wire insulation.

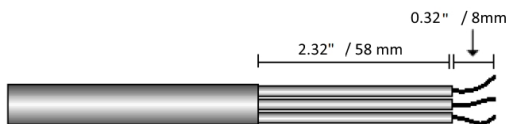

Figure 13: Insulation stripping – AC (3-wire cable)

4. Open the AC cable gland and insert the cable through the gland (see *Figure 5*).

WARNING!



Turn OFF the AC before connecting the AC terminals. If connecting equipment grounding wire, connect it before connecting the AC Line and Neutral wires.

5. For SE25K, SE27.6K, and SE33.3K three phase inverters, attach the supplied Ferrite bead to the AC wires:
 1. Insert the AC wires through the supplied bead.
 2. Connect the AC wires to the terminal blocks as described in the next steps.
 3. Tighten the wires to the bead using the supplied T-wrap.

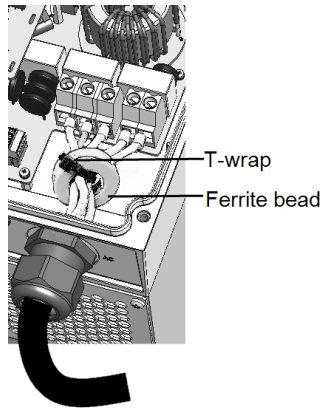

Figure 14: Attaching a Ferrite bead

6. Connect the AC, as follows. Connect the PE (grounding) wire first.

Wire type	Connect to terminal
Line 1	L1
Line 2	L2
Line 3	L3
Neutral	N
PE (grounding)	

Figure 15: AC Terminals

NOTE

If power control is enabled, it is important to respect the order of grid lines connection to the inverter. A 120deg phase difference should be kept between L1 to L2 and between L2 to L3 (L1-L2-L3 and not, for example L1-L3-L2).

If the grid lines are not in this order, an error is displayed on the SetApp screen and the inverter will not produce power.

7. Connect the wires to the appropriate terminal block connectors in the inverter. Tighten the terminal block screws with a torque of 1.2-1.5 N*m / 0.88-1.1 lb*ft.
8. Check that the wires are fully inserted and cannot be pulled out easily.
9. Tighten the AC cable gland with a torque of 2.8-3.3 N*m / 2.0-2.4 lb*ft.
10. Verify that there are no unconnected wires to the inverter and that the unused terminal screws are tightened.

Connecting the Strings to the Inverter

Connect the string to the DC input pairs. If required, connect additional strings in parallel using an external combiner box/branch cables before connecting to the inverter.

NOTE



Functional electrical earthing of DC-side negative or positive poles is prohibited because the inverter has no transformer. Grounding (earth ground) of module frames and mounting equipment of the PV array modules is acceptable.

NOTE



SolarEdge's fixed input voltage architecture enables the parallel strings to be of different lengths. Therefore, they do not need to have the same number of power optimizers, as long as the length of each string is within the permitted range.

Connect the DC connectors of each string to the DC+ and DC- connectors .

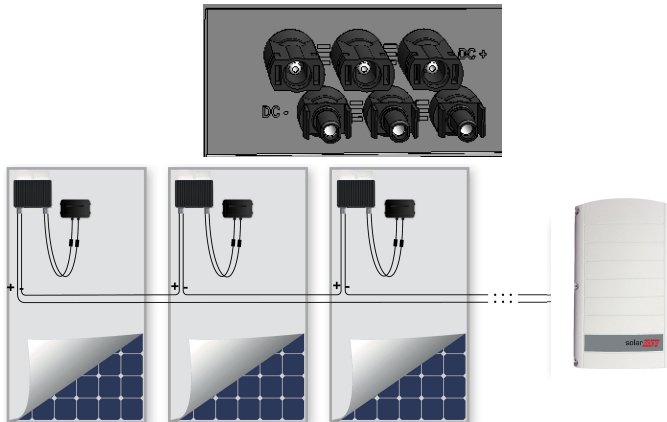

Figure 16: Inverter DC Connections

Selecting a Residual Current Device (RCD)

IMPORTANT SAFETY FEATURE



All SolarEdge inverters incorporate a certified internal Residual Current Device (RCD) in order to protect against possible electrocution and fire hazard in case of a malfunction in the PV array, cables or inverter. There are 2 trip thresholds for the RCD as required for certification (DIN VDE 0126-1-1). The default value for electrocution protection is 30 mA, and for slow rising current is 300 mA.

If an external RCD is required by local regulations, check which type of RCD is required for the relevant electric code. Install the residual-current device (RCD) in accordance with the applicable local standards and directives. SolarEdge recommends using a type-A RCD. The recommended RCD value is 100 mA or 300 mA unless a lower value is required by the specific local electric codes. For extended power three phase inverters (SE25K, SE27.6K and SE33.3K) an RCD value of 300 mA should be used. When required by local regulations, the use of an RCD type B is permitted.

**NOTE**

For multiple inverters, an RCD per inverter is required.

In installations where the local electric code requires an RCD with a lower leakage setting, the discharge current might result in nuisance tripping of the external RCD. The following steps are recommended to avoid nuisance tripping of the external RCD:

- Select the appropriate RCD for correct operation of the installation: An RCD with a rating of 30 mA may actually trip at a leakage as low as 15 mA (according to IEC 61008). High quality RCDs will typically trip at a value closer to their rating.
- Configure the trip voltage of the inverter's internal RCD to a lower value than the trip current of the external RCD. The internal RCD will trip if the current is higher than the allowed current, but because the internal inverter RCD automatically resets when the residual currents are low it saves the manual reset.

For detailed information, refer to the *RCD Selection for SolarEdge Inverters Application Note*, available on the SolarEdge website at http://www.solaredge.com/sites/default/files/application_note_ground_fault_rcd.pdf.



Chapter 5: Activating, Commissioning and Configuring the System Using the Inverter SetApp

If applicable, you can connect communication options at this stage, as described in *Setting Up Communication* on page 49.

Once all connections are made, the system should be activated and commissioned using the Inverter SetApp mobile application. You can download the app from the Apple App Store and Google Play prior to reaching the site.



Internet connection is required for the download and for the one-time registration, however not required for using the SetApp.

Step 1: Activating the Installation

During system activation, a Wi-Fi connection is created between the mobile device and the inverter and the system firmware is upgraded.

Before activation - download, register (first time only) and log-in to SetApp on your mobile device. Internet connection is required for the download and for the one-time registration. Verify that the application is updated with the latest version.

→ **To activate the inverter:**

1. Turn ON the AC circuit breaker on the main distribution panel.
2. Open SetApp and follow the instructions on the screen (scan the inverter bar-code; move the ON/OFF/P switch to P position and release within 5 sec. back to ON (1) position). SetApp creates a Wi-Fi connection, upgrades the inverter CPU firmware and activates the inverter.

3. When the activation is complete, do one of the following:

- Select **Activate Another Inverter** to continue activating additional inverters
- Select **Start Commissioning** for pairing and other system configuration. The Commissioning screen is displayed. Refer to the next section for more information.

Step 2: Commissioning and Configuring the Installation

This section describes how to use the SetApp menus for commissioning and configuring the inverter settings.

Menus may vary in your application depending on your system type.

→ To access the Commissioning screen:

Do one of the following:

- During first time installation: Upon Activation completion, in the SetApp, tap **Start Commissioning**. The main Commissioning menu screen is displayed.
- If the inverter has already been activated and commissioned:
 - If not already ON - turn ON AC to the inverter by turning ON the circuit breaker on the main distribution panel.
 - Open SetApp and follow the instructions on the screen (scan the inverter bar-code; move the ON/OFF/P switch to P position (for less than 5 sec) and release).

The mobile device creates a Wi-Fi connection with the inverter and displays the main Commissioning screen.

In the main menus, tap the menu red arrows (➤) to perform the system commissioning or configuration task. Tap the **Back** arrow (◀) to return to the previous menu.

The next sections provide more information about configuration options (in addition to **Country and Language** and **Pairing**, described in *Step 2: Commissioning and Configuring the Installation* on page 36).

Setting Country and Language

1. From the Commissioning screen select **Country and Language** .
2. From the **Country** drop-down list, select the required country setting.

WARNING!

The inverter must be configured to the proper setting in order to ensure that it complies with the country grid code and functions properly with the country grids.

3. From the **Language** drop-down list, select the language.
4. Tap **Set Language**.

Pairing

1. From the main menu, select **Pairing**.
2. Tap **Start Pairing**.
3. When **Pairing Complete** is displayed, the system startup process begins:
Since the inverter is ON, the power optimizers start producing power and the inverter starts converting AC.

WARNING!

When you turn ON the inverter ON/OFF/P switch, the DC cables carry a high voltage and the power optimizers no longer output a safe 1V output.

When the inverter starts converting power after the initial connection to the AC, the inverter enters Wakeup mode until its working voltage is reached. This mode is indicated by the flickering green inverter LED.

When working voltage is reached, the inverter enters Production mode and produces power. The steadily lit green inverter LED indicates this mode.

4. Tap **OK** to return to the main menu.

Communication

Communication settings can be configured only after communication connections are complete. Refer to *Setting Up Communication* on page 49.

1. Select the **Communication** menu to define and configure the following:
 - The communication option used by the inverter to communicate with the monitoring platform
 - The communication option used to communicate between multiple SolarEdge devices or other external non-SolarEdge devices, such as electricity meters or loggers.
2. Tap the **Server** red arrow to set the communication method to be used for

communication between devices and the SolarEdge monitoring platform. The default is LAN.



NOTE

The Server menu shows only the communication options installed in the inverter.

For detailed information about all the configuration options, refer to the *Communication Options Application Note*, available on the SolarEdge website at https://www.solaredge.com/sites/default/files/solaredge-communication_options_application_note_v2_250_and_above.pdf.



Power Control

Power control options are detailed in the *Power Control Application Note*, available on the SolarEdge website at https://www.solaredge.com/sites/default/files/application_note_power_control_configuration.pdf.



The Grid Control option may be disabled. Enabling it opens additional options in the menu.

The Energy Manager option is used for setting power export limitation, as described in the *Export Limitation Application Note*, available on the SolarEdge website at https://www.solaredge.com/sites/default/files/feed-in-limitation_application_note.pdf.



Device Manager

From the **Commissioning** menu, select **Device Manager** to configure various system Smart Energy Management devices.

For more information refer to <https://www.solaredge.com/products/device-control/#/>.



Maintenance

From the **Commissioning** menu, select **Maintenance** to configure various system settings, as described below.

- **Date and Time:** Set the internal real-time clock. If connected to the monitoring platform, the date and time are set automatically and only time zone should be set.
- **Reset Counters:** Resets the accumulated energy counters that are sent to the monitoring platform
- **Factory Reset:** Performs a general reset to the default device settings.
- **Arc Fault Circuit Interrupter (AFCI):** Enables or disables production interruption in case of arc-fault, sets the reconnection mode, and enables or disables manual AFCI self-test.

Refer to https://www.solaredge.com/sites/default/files/arc_fault_detection_application_note.pdf.



- **Firmware Upgrade:** Perform a software upgrade.
- **Diagnostics:** Displays the Isolation status and power optimizer status screens. Refer to https://www.solaredge.com/sites/default/files/application_note_isolation_fault_troubleshooting.pdf.



- **Activate Standby Mode:** Enables/disables Standby Mode - for remote commissioning.
- **Grid Protection:** Available in specific countries. Enables viewing and setting grid protection values.
- **Board Replacement:** Backs up and restores the system parameters, including energy counters; Used during board replacement according to the instructions supplied with replacement kits.

Information

From the **Commissioning** menu, select **Information** to view and set various system settings, as described below.

- **CPU Version:** The communication board firmware version
- **DSP 1/2 Version:** The digital board firmware version



NOTE

Please have these numbers ready when you contact SolarEdge Support.

- **Serial Number** - The inverter serial number as appears on the enclosure sticker

- **Hardware IDs:** Displays the following HW serial numbers (if exist, and connected to the inverter):
 - **This inverter:** the inverter's ID
 - **Meter # :** Energy meter ID (up to 3 meters can be connected)
 - **ZB:** ZigBee Plug-in MAC address
 - **WiFi:** Wi-Fi MAC address
- **Error Log:** Displays the last five errors, and enables resetting (clearing) the log.
- **Warning Log:** Displays the last five warnings, and enables resetting (clearing) the log.

Step 3: Verifying Proper Activation and Commissioning

1. Select **Information** and verify that the correct firmware versions are installed on each inverter.
2. Select **Status** and verify that inverter is operating and producing power (see also *Viewing System Status* on page 40).
3. Verify that additional configurations were properly set by viewing the relevant Status screens.
4. Verify that the green inverter LED is steadily lit.

Your SolarEdge power harvesting system is now operational.

Viewing System Status

During normal operation, the **Status** screen displays all the inverter settings and operation status. Scroll up or down to display various status parameters as described in the following sections.

The LED indication provides more information about system performance; Refer to *LEDs* on page 22.

→ **To access the Status screen:**

From the **Commissioning** menu select **Status**. The main inverter Status screen is displayed (see below).

A red or orange icon (for example: ) may appear at the top left corner of a status cell, indicating an error. The color indicates error severity (red is top severity). The error description or information appears on the screen. Tap the error line for more information and troubleshooting instructions, and refer to *Errors and Troubleshooting* on page 62.

A gray clock icon (🕒) may appear at the top left corner of a status cell, indicating a temporary status, such as a connection process. When the process is complete, the icon disappears and a constant status message is displayed.

Main Inverter Status

solar		
Status		
Inverter		
SN 07318000C		
Power 50 kW	Voltage 230Vac	Frequency 50 Hz
🕒 P_OK: 15 of 20 Optimizers Connected	Server Comm. S_OK (LAN)	
Status Production	⚠️ Switch OFF	
CosPhi 1.00	Limit No Limit	Country Netherlands
Voltage 350 Vdc	Temp 20 C	Fan N/A
⚠️ Switch Off. Production disabled >		
Commissioning >		

- **Inverter:** The inverter serial number
- **Power:** The AC output power
- **Voltage (Vac):** The AC output voltage
- **Frequency:** The AC output frequency
- **S_OK:** The connection to the monitoring platform. (**Server Connected** appears only if the inverter is connected to the monitoring platform).
- **Status:** The inverter operation status: Off, Not Paired, Night Mode, Error, Pairing, or Production

- **Switch:** Indicates the position of the inverter ON/OFF/P switch: On, Off, or P position.
- **CosPhi:** Indicates the ratio between active and reactive power. A negative value indicates a lagging CosPhi.

For more information, refer to the *Power Control Application Note*, available on the SolarEdge website at https://www.solaredge.com/sites/default/files/application_note_power_control_configuration.pdf.



- **Limit:** The inverter maximum output power
- **Country:** The selected country and grid setting
- **Voltage (Vdc):** The DC input voltage
- **Temp** (°C or °F): The inverter heat sink temperature

Site Status

The Site status screen shows the accumulated status of all inverters connected to a master inverter in a chain (bus) and the master inverter status.

solar edge		
Status		
Site		
Production	Limit	Inverters
90 kW	1.00 MW	10/10
Inverter		
SN 07318000C		
Power	Voltage	Frequency
100 kW	277 Vac	60.9 Hz
P_OK: 31 Of 31		S_OK
Optimizers Connected		Server Connected
Status	⚠	Switch
Production		OFF
CosPhi	Limit	Country
1.00	Export	ITA
⚠ Switch Off. Production disabled >		
Commissioning >		

Site status:

- Production:** The AC output power
- Limit:** Limitation setting (Export or Production)
- Inverters:** Number of connected inverters in the cluster, including the master.

Communication Status

This screen displays the status of connection option(s): LAN, RS485, Wi-Fi, cellular or ZigBee Plug-in.

Communication		
LAN Connected	RS485-1 SE Slave NC	RS485-2 Modbus 2 of 2
Cellular N/A	Wi-Fi NC	ZigBee MP Slave M not Found

For each communication option, one of the following statuses is displayed:

- **Connected:** The inverter established a successful connection and communication with the specified server port
- **NC:** Not Connected. Refer to *Troubleshooting Communication* on page 64
- **S_OK:** The connection to the monitoring platform is successful (should appear only if the inverter is connected to the server)
- **N/A :** Not Applicable
- **x of y:** Number of devices connected out of all devices
- Temporarily displayed (with a ⌚ clock sign):
 - **Initializing communication**
 - **Connecting** to a network
 - **Connecting** to SolarEdge servers
- **Error message** (with the ⚠ sign). Refer to *Troubleshooting Communication* on page 64.

Inverter Energy Status

Displays the total energy produced during the last day, month, year and since inverter installation.

Inverter Energy		
Today	This Month	This Year
45 kWh	1.14 MWh	13.68 MWh
Total: 41.03 MWh		

- **Today:** since midnight
- **This Month:** since 1st of the current month
- **This Year:** since January 1st
- **Total (Wh):** The inverter total energy. If an external meter is installed, the value displayed in this line depends on the meter type connected to the inverter and its location:
 - If a bidirectional meter is connected at the consumption point, this value is the consumed energy.
 - If the meter is installed at the production point, this value is the energy produced by the site.
 - If the meter is installed at the grid connection point, this value is the energy exported to the grid.

Meter Status

Meters
Export – RS485-2 Modbus ID #2 Status: OK

- **Type and function:** Displays the meter functionality (Production, Export, Import, Export+Import)
- **Status:** Displays OK if the meter is communicating with the inverter
- **<Error message>:** If there is a meter error, it is displayed in this line.
- **Power:** Depending on the meter type connected to the inverter, this line displays the exported or imported power
- **Energy:** The total energy read by the meter. The value displayed in this line depends on the meter type connected to the inverter and its location:
 - If a bidirectional meter is connected at the consumption point, this value is the consumed energy.
 - If the meter is installed at the production connection point, this value is the energy produced by the site.
 - If the meter is installed at the grid connection point, this value is the energy exported to the grid.

**NOTE**

This data is accumulated according to an internal real-time clock.

Reporting and Monitoring Installation Data

**NOTE**

Monitoring the site requires connecting the inverter to the monitoring platform, using any of the wired or wireless options available from SolarEdge. Refer to *Setting Up Communication* on page 49.

The Monitoring Platform

The monitoring platform provides enhanced PV performance monitoring and yield assurance through immediate fault detection and alerts at the module, string and system level.

Using the platform, you can:

- View the latest performance of specific components.
- Find under-performing components, such as modules, by comparing their performance to that of other components of the same type.
- Pinpoint the location of alerted components using the physical layout.

The monitoring platform enables accessing site information, including up-to-date information viewed in a physical or logical view:

- **Logical Layout:** Shows a schematic tree-layout of the components in the system, such as: inverters, strings, modules, meters and sensors, as well as their electrical connectivity. This view enables you to see which modules are connected in each string, which strings are connected to each inverter, and so on.
- **Physical Layout:** Provides a bird's eye view of the actual placement of modules in the site, and allows pinpoint issues to the exact location of each module on a virtual site map.

If you do not report the mapping of the installed power optimizers, the monitoring platform will show the logical layout indicating which power optimizers are connected to which inverter, but will not show strings or the physical location of power optimizers.

The monitoring platform includes a built-in help system, that guides you through the monitoring functionality.

For more information, refer to <https://www.solaredge.com/products/pv-monitoring#/>.



Creating Logical and Physical Layout using Installation Information

To display a logical layout, insert the inverterserial number in the new site created in the monitoring platform. When the communication between the inverter and the monitoring server is established, the logical layout is displayed.

To display a physical layout, you need to map the locations of the installed power optimizers. To map the locations, use one of the methods described in the next sections.

Designer

Designer recommends inverter and power optimizer selection per site size and enables report generation. You can create a project in Designer and export the site design with the string layout to the monitoring platform.

For more information, refer to

<https://www.solaredge.com/products/installer-tools/designer#/>.



Mapper Application

Use the Mapper smart phone application to scan the power optimizer and inverter 2D bar-codes and create a virtual map of a PV site for enhanced monitoring and easier maintenance.

The Mapper application is integrated with the monitoring platform and enables:

- Simple on-site registration of new systems.
- Creating, editing and verifying system physical layout.
- Scanning and assigning the power optimizer serial number to the correct module in the system physical layout.

For detailed information, refer to the *Mapper* demo movies:

- [Creating new sites using the Mapper mobile application](#)
- [Mapping existing sites using the Mapper mobile application](#)



Physical Layout Editor

1. If you are a registered installer, access the monitoring platform site creation page at <https://monitoring.solaredge.com/solaredge-web/p/home#createSites>. If you have not yet signed up, go to <https://monitoring.solaredge.com/solaredge-web/p/createSelfNewInstaller>.
2. Fill out all required information in the screen, which includes information about your installation, as well as details about its logical and physical mapping.

Using a Paper Template

Fill out the Physical Layout Template (downloadable from the SolarEdge website <http://www.solaredge.com/files/pdfs/physical-layout-template.pdf>) using the detachable 2D barcode stickers on each power optimizer. Once the form is completed, use the Mapper to scan the 2D codes and create the map in the monitoring platform. Optionally, you can send the sticker sheet to SolarEdge Support for physical layout creation.



Chapter 6: Setting Up Communication

The inverter sends the following information to the monitoring platform:

- Power optimizer information received via the DC power lines (the PV output circuit).
- Inverter information
- Information of any other connected devices.

This chapter describes setting up communication between:

- The inverter and the monitoring platform through the Internet (wired/ wireless), or through a cellular connection.
- Multiple inverters for a master/slave configuration.

Communication setup is not required for power harvesting, however it is needed for using the monitoring platform.

CAUTION!



When connecting the communication cables, make sure that the ON/OFF/P switch at the bottom of the inverter (and the switch of the DC Safety Unit if applicable) is turned OFF, and the AC is turned OFF.

When configuring the communication parameters *while the inverter cover is removed*, make sure that the ON/OFF/P switch (and the switch of the DC Safety Unit if applicable) is OFF, and the AC is turned ON.

Communication Options

The following types of communication can be used to transfer the monitored information from the inverter to the monitoring platform.

Only communication products offered by SolarEdge are supported.

Always connect the communication options when the relevant devices are powered down - Commercial Gateway, inverter, etc.

Ethernet

Ethernet is used for a LAN connection. For connection instructions refer to *Creating an Ethernet (LAN) Connection* on page 52 .

RS485

RS485 is used for the connection of multiple SolarEdge devices on the same bus in a master-slave configuration. RS485 can also be used as an interface to external devices, such as meters and third party data loggers.

- RS485-1: Enables the connection of multiple devices (inverters/Commercial Gateway) over the same bus, such that connecting only one device to the Internet is sufficient to provide communication services for all the devices on the bus.
- RS485-2: Enables connection of multiple SolarEdge devices and of non-SolarEdge devices over the same bus.

Wi-Fi

This communication option enables using a Wi-Fi connection for connecting to the monitoring platform.

The Wi-Fi station is built into the inverter. An antenna is required and available from SolarEdge for connection to the monitoring platform.

Cellular (GSM, CDMA)

This wireless communication option (purchased separately) enables using a cellular connection to connect one or several devices (depending on the data plan used) to the monitoring platform.

The GSM/CDMA Plug-in is provided with a user manual, which should be reviewed prior to connection. Refer to https://www.solaredge.com/sites/default/files/cellular_gsm_installation_guide_for_inverters_with_setapp.pdf



ZigBee

This option enables wireless connection to one or several Smart Energy products, which automatically divert PV energy to home appliances.

The Smart Energy products are provided with an installation guide, which should be reviewed prior to connection. Refer to <https://www.solaredge.com/products/device-control#/>.

The ZigBee station is built into the inverter. An antenna is required and available from SolarEdge.



Communication Connectors

Two communication glands are used for connection of the various communication options. Each gland has three openings. The table below describes the functionality of each opening. Unused openings should remain sealed.

Gland#	Opening	Functionality	Cable size (diameter)
1 (PG16)	One small	External antenna cable	2-4 mm
	Two large	Ethernet connection (CAT5/6), Cellular, ZigBee, or Wi-Fi	4.5-7 mm
2 (PG13.5)	All three	RS485, power reduction	2.5-5 mm

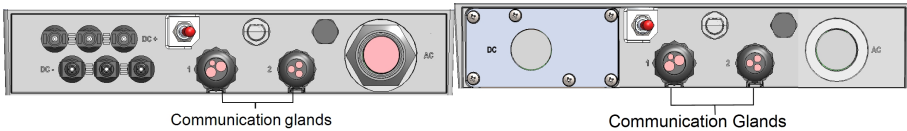

Figure 17: Communication Glands

The communication board has a standard RJ45 terminal block for Ethernet connection, and a 6-pin terminal block for RS485 connection, as shown below:

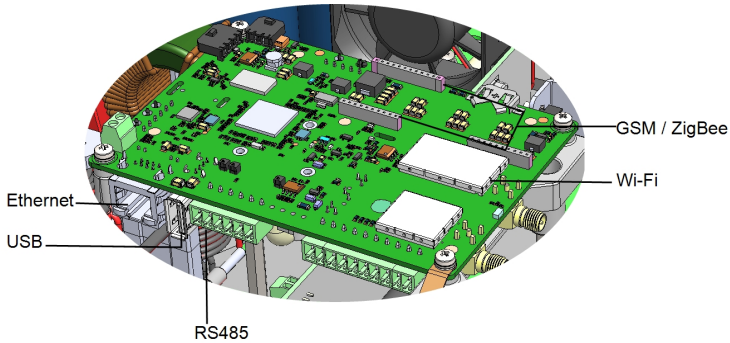

Figure 18: Internal connectors

Removing the Inverter Cover

If the inverter cover is not already removed, use the following procedure for cover removal.

→ To remove the inverter cover

1. Turn the inverter ON/OFF/P switch to OFF. Wait 5 minutes for the capacitors to discharge.
2. Turn the Connection Unit (if applicable) to OFF.
3. Disconnect the AC to the inverter by turning OFF the circuit breakers on the distribution panel.
4. Open the Allen screws of the inverter cover and carefully pull the cover horizontally before lowering it.

CAUTION!



When removing the inverter cover, make sure not to damage the internal components. SolarEdge will not be held responsible for any components damaged as a result of incautious cover removal.

Creating an Ethernet (LAN) Connection

This communication option enables using an Ethernet connection to connect the inverter to the monitoring platform through a LAN.

Ethernet cable specifications:

- Cable type – a shielded Ethernet cable (Cat5/5E STP) may be used
- Maximum distance between the inverter and the router – 100 m/ 330 ft.

NOTE



If using a cable longer than 10 m / 33 ft in areas where there is a risk of induced voltage surges by lightning, it is recommend to use external surge protection devices.

For details refer to: http://www.solaredge.com/files/pdfs/lightning_surge_protection.pdf.



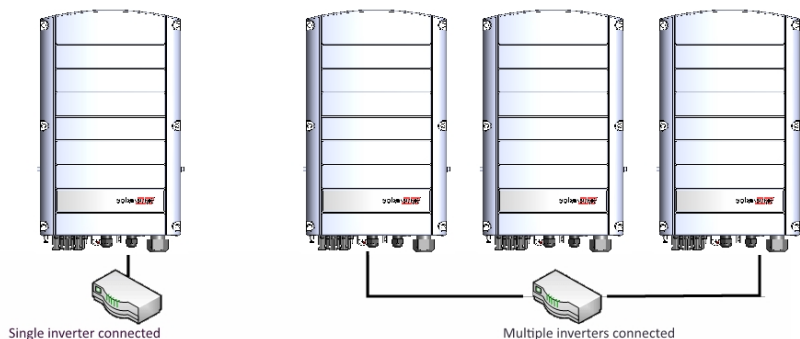

Figure 19: Example of Ethernet connection

→ To connect the Ethernet cable:

1. Remove the inverter cover .
2. Open the communication gland #1.



CAUTION!

The gland includes a rubber waterproof fitting, which should be used to ensure proper sealing.

3. Remove the plastic seal from one of the large opening .
4. Remove the rubber fitting from the gland and insert the CAT5/6 cable through the gland and through the gland opening in the inverter .
5. Push the cable into the cut opening of the rubber fitting.

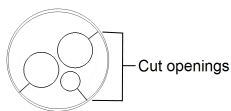

Figure 20: Rubber fitting

CAT5/6 standard cables have eight wires (four twisted pairs), as shown in the diagram below. Wire colors may differ from one cable to another. You can use either wiring standard, as long as both sides of the cable have the same pin-out and color-coding.

RJ45 Pin #	Wire Color ⁽¹⁾		10Base-T Signal 100Base-TX Signal
	T568B	T568A	
1	White/Orange	White/Green	Transmit+
2	Orange	Green	Transmit-
3	White/Green	White/Orange	Receive+
4	Blue	Blue	Reserved
5	White/Blue	White/Blue	Reserved
6	Green	Orange	Received-
7	White/Brown	White/Brown	Reserved
8	Brown	Brown	Reserved

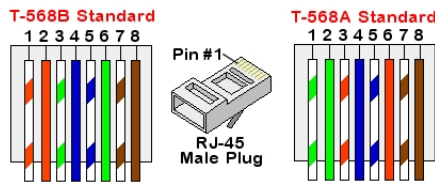

Figure 21: Standard cable wiring

6. Use a pre-terminated cable to connect via gland #1 to the RJ45 plug on the inverter's communication board or, if using a spool of cable, connect as follows:
 - a. Insert the cable through gland #1.
 - b. Remove the cable's external insulation using a crimping tool or cable cutter and expose eight wires.
 - c. Insert the eight wires into an RJ45 connector, as described in *Figure 21*.
 - d. Use a crimping tool to crimp the connector.
 - e. Connect the Ethernet connector to the RJ45 port on the communication board.

⁽¹⁾The inverter connection does not support RX/TX polarity change. Supporting crossover Ethernet cables depends on the switch capabilities.

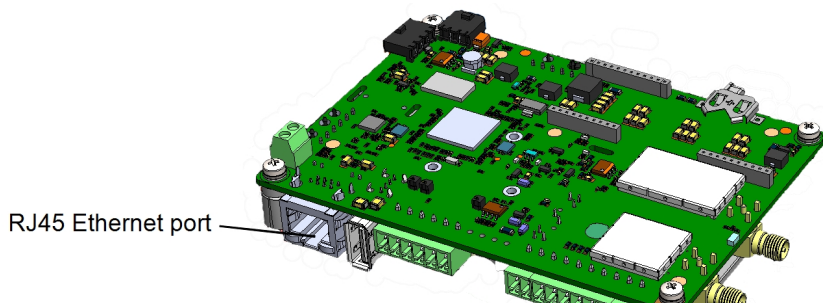

Figure 22: The RJ45 Ethernet connection

7. For the switch/router side, use a pre-terminated cable or use a crimper to prepare an RJ45 communication connector: Insert the eight wires into the RJ45 connector in the same order as above (*Figure 21*).
8. Connect the cable RJ45 connector to the RJ45 port of the Ethernet switch or router. You can connect more than one inverter to the same switch/router or to different switches/routers, as needed. Each inverter sends its monitored data independently to the monitoring platform.
9. The inverter is configured by default to LAN. If reconfiguration is required:
 - a. Make sure the ON/OFF/P switch is OFF.
 - b. Turn ON the AC to the inverter by turning ON the circuit breaker on the main distribution panel.
 - c. Configure the connection as described in *Communication* on page 37.

NOTE



If your network has a firewall, you may need to configure it to enable the connection to the following address:

- Destination Address: prod2.solaredge.com
- TCP Port: 22222, 22221, or 80 (for incoming and outgoing data)

10. Verify the connection, as described in *Verifying the Connection* on page 60.

Creating an RS485 Bus Connection

The RS485 option enables creating a bus of connected inverters, consisting of up to 31 slave inverters and 1 master inverter. Using this option, inverters are connected to each other in a bus (chain), via their RS485 connectors. The first and last inverters in the chain must be terminated as described on page 58.

RS485 wiring specifications:

- Cable type: Min. 3-wire shielded twisted pair (a shielded Ethernet cable (Cat5/5E STP) may be used)
- Wire cross-section area: 0.2- 1 mm²/ 24-18 AWG (a CAT5 cable may be used)
- Maximum nodes: 32
- Maximum distance between first and last devices: 1 km /3300 ft.

NOTE

If using a cable longer than 10 m/33 ft in areas where there is a risk of induced voltage surges by lightning, it is recommend to use external surge protection devices. For details refer to:

https://www.solaredge.com/sites/default/files/lightning_surge_protection.pdf.



If grounded metal conduit are used for routing the communication wires, a lightning protection device is not required.

If not using surge protection, connect the grounding wire to the first inverter in the RS485 chain; ensure it is not in contact with other wires. For inverters with a DC Safety Unit, connect the grounding wire to the grounding bus-bar in the DC Safety Unit.

The following sections describe how to physically connect the RS485 bus and how to configure the bus.

→ **To connect the RS485 communication bus:**

1. Remove the inverter cover as described in *Removing the Inverter Cover* on page 52.
2. Remove the seal from one of the openings in communication gland #2 and insert the wire through the opening.
3. Pull out the 6-pin RS485 terminal block connector, as shown below:

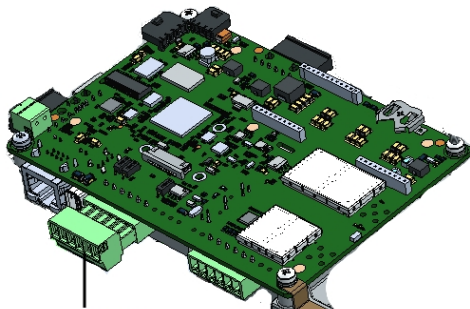

RS485 connector

Figure 23: The RS485 terminal block

4. Loosen the screws of pins A(+), B(-), and G on the left of the RS485 terminal block (RS485-1 or RS485-2).

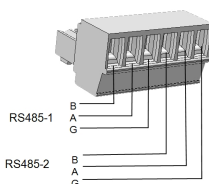

Figure 24: RS485 terminal block

5. Insert the wire ends into the **G**, **A** and **B** pins shown above. Use Four- or six-wire twisted pair cable for this connection.

You can use any color wire for each of the **A**, **B** and **G** connections, as long as:

- The same color wire is used for all A pins the same color for all B pins and the same color for all G pins
- The wire for G is not from the same twisted pair as A or B.

6. For creating an RS485 bus - connect all B, A and G pins in all inverters. The following figure shows this connection schema:

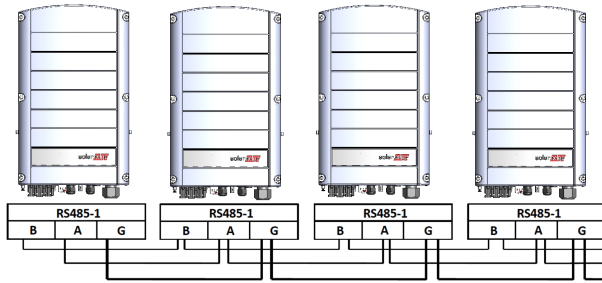

Figure 25: Connecting the inverters in a chain

**NOTE**

Do not cross-connect B, A and G wires.

7. Tighten the terminal block screws.
8. Check that the wires are fully inserted and cannot be pulled out easily.
9. Push the RS485 terminal block firmly all the way into the connector on the right side of the communication board.
10. Terminate the first and last SolarEdge device in the chain by switching a termination DIP-switch inside the inverter to ON (move the left switch up). The switch is located on the communication board and is marked SW7SW1.

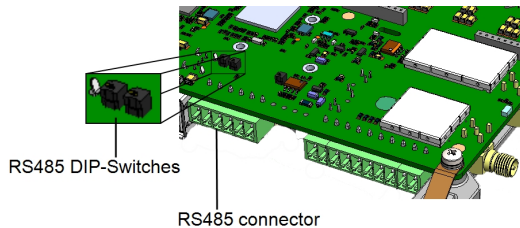

Figure 26: RS485 termination switch

NOTE

Only the first and last SolarEdge devices in the chain should be terminated. The other inverters in the chain should have the termination switch OFF (down position).

11. If not using surge protection, connect the grounding wire to the first inverter in the RS485 chain; make sure the grounding wire is not in contact with other wires. For inverters with a DC Safety Unit, connect the grounding wire to the grounding busbar in the DC Safety Unit.

→ To connect to the monitoring platform:

1. Designate a single inverter as the connection point between the RS485 bus and the monitoring platform. This inverter will serve as the master inverter.

→ To configure the RS485 bus:

All inverters are configured by default as slaves. To configure the master:

1. Verify the ON/OFF/P switch is OFF.
2. Verify that AC is on.
3. Use SetApp to access the **Commissioning** menu screen as described in *Communication* on page 37.
4. From the **Commissioning** menu tap **Communication**. The Communication screen is displayed.
5. Select the following to configure the connection:
 - Server → LAN
 - RS485-1 → Protocol → **SolarEdge Master**
 - RS485-1 → **Slave Detect**

The system starts automatic detection of the slave inverters connected to the master inverter. The inverter should report the correct number of slaves. If it does not, verify the connections and terminations.

6. To check the slave IDs and last communication time, select **RS485-1 → Slave List**.
7. Verify the connection of the master to the monitoring platform, as described in the next section.

Verifying the Connection

After connecting and configuring a communication option, perform the following steps to check that the connection to the monitoring server has been successfully established.

1. Access the Status screen:
 - a. If not already ON - turn ON AC to the inverter by turning ON the circuit breaker on the main distribution panel.
 - b. Open SetApp and follow the instructions on the screen (scan the inverter bar-code; move the ON/OFF/P switch to P position (for less than 5 sec) and release). The mobile device creates a Wi-Fi connection with the inverter and displays the main Commissioning screen.

solar edge		
Status		
Inverter		
SN 07318000C		
Power	Voltage	Frequency
Optimizers Connected	S_OK Server Connected	
Status		Switch
Production		ON
CosPhi	Limit	Country
1.00	No Limit	Netherlands
Voltage	Temp	Fan
Commissioning		

2. Check that **S_OK - Server Connected** status appears in the main inverter section.
3. Scroll down to the Communication section and check that the communication options are as required. For more information refer to *Communication Status* on page 43.

Communication		
LAN Connected	RS485-1 SE Slave NC	RS485-2 Modbus 2 of 2
Cellular N/A	Wi-Fi NC	ZigBee MP Slave M not Found

Appendix A: Errors and Troubleshooting

This appendix describes general system problems, and how to troubleshoot them. For further assistance, contact SolarEdge Support.

Identifying Errors

Errors may be indicated in various system interfaces: On the inverter bottom panel, a red LED indicates an error. In the monitoring platform and the SetApp, errors are displayed with codes.

For more information on the codes displayed for error and warning messages, refer to <http://www.solaredge.com/sites/default/files/se-inverter-installation-guide-error-codes.pdf>. This document describes errors that appear in SetApp, monitoring platform, and LCD (for inverters with LCD).



To identify the error types, use the methods described below.

→ To identify the error type using the inverter LEDs:

1. Move the ON/OFF/P switch to **P** position for **less** than 5 seconds and release it.
2. Observe the LED lights and use the following table to identify the error type. For more information, refer to <https://www.solaredge.com/leds>.



Error type	LED color and state		
	Red	Green	Blue
Arc detected	ON	OFF	OFF
Isolation or RCD problem	Blinking	OFF	OFF
Grid error	OFF	ON	OFF
High temperature	OFF	Blinking	OFF
Pairing failed	OFF	OFF	ON
Other issue	OFF	OFF	Blinking

→ To identify the error type using the monitoring platform:

1. Open the site dashboard and click the **Layout** icon.
2. Right-click the inverter and select **Info** from the menu (*Figure 27*). The inverter details window is displayed (*Figure 28*).

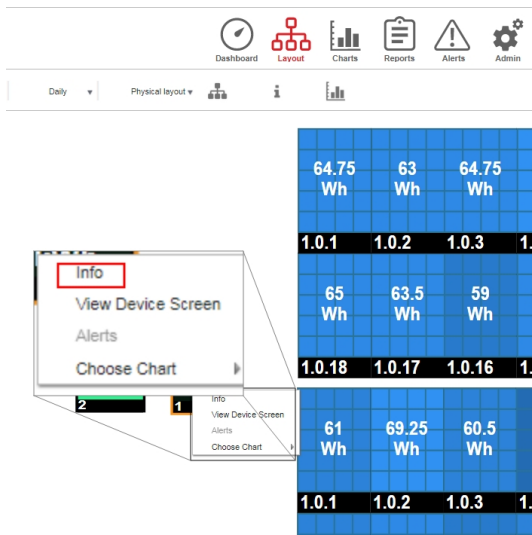

Figure 27: Inverter menu

3. Click the **Errors** tab. The list is displayed.

Details for Inverter 1

System data Running operations Device screen **Errors**

Your last refresh: 10/18/2017 10:32 AM Refresh

Code	QTY	Description	Last Occurrence	
119	1	INIT	10/10/2017 07:55	>
61	1	AC Voltage Too Low (Line 1)	09/20/2017 14:32	>
63	1	AC Voltage Too Low (Line 2)	09/20/2017 14:32	>

Figure 28: Inverter details - Error list

Troubleshooting Communication

Troubleshooting Ethernet (LAN) Communication

The possible errors and their troubleshooting are detailed in the following table:

Error Message	Cause and Troubleshooting
LAN cable disconnected	Physical connection fault. Check the cable pin-out assignment and cable connection
No DHCP	IP settings issue. Check the router and inverter configuration. Consult your network IT.
Configure Static IP or set to DHCP	
Gateway not responding	Ping to router failed. Check the physical connection to the switch/ router. Check that the link LED at the router /switch is lit (indicating phy-link). If OK - contact your network IT, otherwise replace the cable or change it from cross to straight connection.
No Internet connection	Ping to google.com failed. Connect a laptop and check for internet connection. If internet access is unavailable, contact your IT admin or your internet provider. For Wi-Fi networks, ensure that user-name and password are as defined in the internet provider AP/ router.
No connection to SolarEdge servers	Ping or connection to SolarEdge server failed. Check the SolarEdge server address, under LAN Conf sub-menu: Address: prod.solaredge.com Port: 22222 Check with your network administrator whether a firewall or another device is blocking transmission.

Troubleshooting RS485 Communication

- If the message **RS485 Master Not Found** appears in the Status screen, check the connections to the master device and fix if required.
- If after slave detection the number of slaves displayed for the master under **RS485-X Conf → Slave Detect** is lower than the actual number of slaves, refer to the following application note to identify missing slaves and troubleshoot connectivity problems:

https://www.solaredge.com/sites/default/files/troubleshooting_undetected_RS485_devices.pdf

Additional Troubleshooting

1. Check that the modem or hub/router is functioning properly.
2. Check that the connection to the internal connector on the communication board is properly done.
3. Check that the selected communication option is properly configured.
4. Use a method independent of the SolarEdge device to check whether the network and modem are operating properly. For example, connect a laptop to the Ethernet router and connect to the Internet.
5. Check whether a firewall or another type of network filter is blocking communication.

Power Optimizer Troubleshooting

Problem	Possible cause and troubleshooting
Pairing failed	<p>Power optimizers are shaded.</p> <p>If you connected the inverter to the monitoring platform, retry pairing remotely (during sunlight). Make sure to leave the inverter ON/OFF switch ON and that S_OK appears in the status screen.</p>
String voltage is 0V	<p>Power optimizer (s) output is disconnected.</p> <p>Connect all power optimizer outputs.</p>
String voltage not 0V but lower than number of optimizers	<p>Power optimizer(s) not connected in the string.</p> <p>Connect all power optimizers</p>
	<p>Module(s) not connected properly to power optimizer inputs (not applicable to smart modules).</p> <p>Connect the modules to the optimizer inputs</p>
	<p>String reverse polarity.</p> <p>Check string polarity using a voltmeter and correct if needed.</p>

Problem	Possible cause and troubleshooting
<p>String voltage is higher than number of optimizers</p> <div style="border: 1px solid black; padding: 5px; margin-top: 10px;"> <p>WARNING!</p> <p> If the measured voltage is too high, the installation may not have a safe low voltage. PROCEED WITH CARE! A deviation of $\pm 1\%$ per string is reasonable.</p> </div>	<p>Extra power optimizer(s) connected in the string (not applicable to smart modules). Check if an extra power optimizer is connected in the string. If not – proceed to next solution.</p> <p>A module is connected directly to the string, without a power optimizer (not applicable to smart modules). Verify that only power optimizers are connected in the string and that no module outputs are connected without a power optimizer. If the problem persists, proceed to the next step.</p> <p>Power optimizer(s) malfunction.</p> <ol style="list-style-type: none"> 1. Disconnect the wires connecting the power optimizers in the string. 2. Measure the output voltage of each power optimizer to locate the power optimizer that does not output 1V safety voltage. If a malfunctioning power optimizer is located, check its connections, polarity, module, and voltage. 3. Contact SolarEdge Support. Do not continue before finding the problem and replacing the malfunctioning power optimizer. If a malfunction cannot be bypassed or resolved, skip the malfunctioning power optimizer, thus connecting a shorter string.

Appendix B: Mechanical Specifications

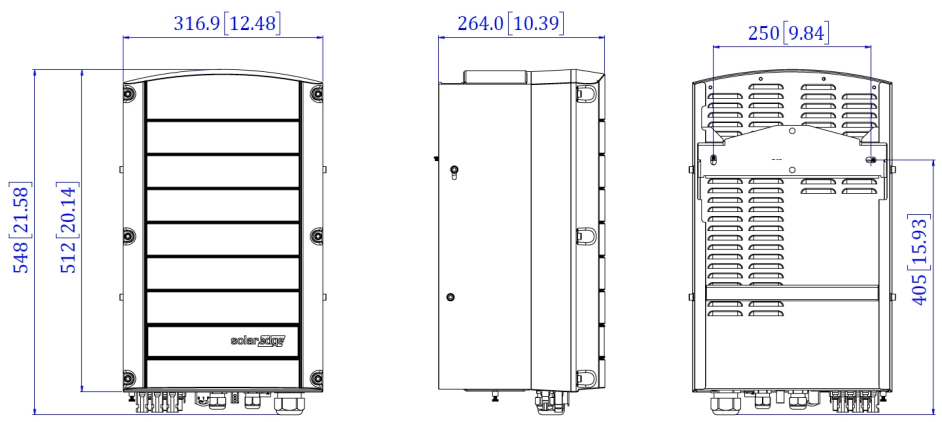

Figure 29: Inverter with bracket - front, side and rear views

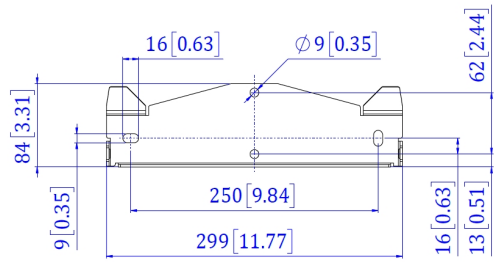

Figure 30: Inverter mounting bracket

Appendix C: Connecting the AC and DC Strings to the DC Safety Unit

Some inverter models are supplied with an integrated DC Safety Unit. This appendix describes how to connect the AC grid and DC strings to the DC Safety Unit.

The DC Safety Unit includes:

- Mechanical DC switch (2-pole disconnection)
- DC surge protection (SPD, Type II)
- DC fuses (plus & minus; optional)

This appendix describes connections to DC Safety Unit with or without fuses. The following figure illustrates the DC Safety Unit supplied with fuses.

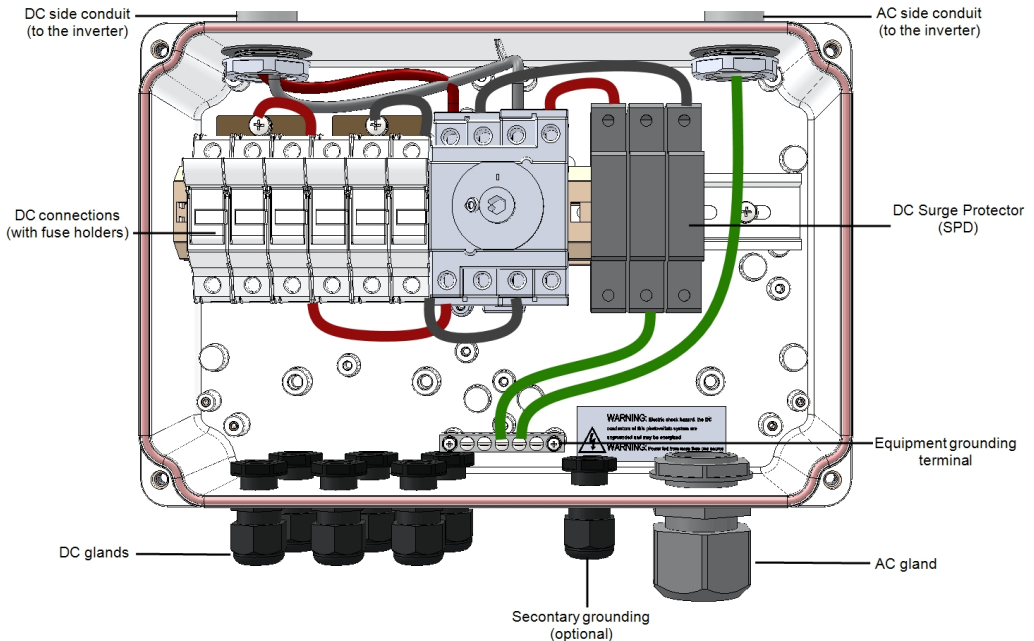

Figure 31: Inside the DC Safety Unit with fuses

Connecting the AC Grid to the Inverter

Use a five-wire cable for this connection. The maximum wire size for the input terminal blocks is 16 mm².

→ To connect the AC grid to the inverter via the DC Safety Unit:

1. Turn OFF the following:
 - The inverter ON/OFF switch
 - The AC circuit breaker
 - The DC Safety Unit
2. Open the inverter cover: Release the Allen screws and carefully move the cover horizontally before lowering it.

CAUTION!



When removing the cover, make sure not to damage internal components. SolarEdge will not be held responsible for any components damaged as a result of incautious cover removal.

3. Loosen the screws on the front cover of the DC Safety Unit, as shown below:

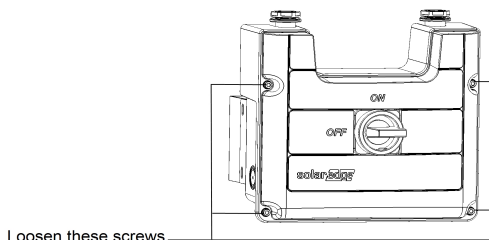

Figure 32: Opening the DC Safety Unit cover

4. Remove the DC Safety Unit cover.
5. Strip 35 cm of the external cable insulation and strip 8 mm of the internal wire insulation.

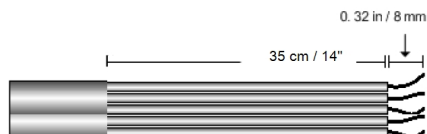

Figure 33: Insulation stripping – AC

6. Open the AC cable gland and insert the cable through the gland (see *Figure 31*).

7. Connect the grounding wire to the equipment grounding terminal in the DC Safety Unit.

NOTE

Connect the equipment grounding before connecting the AC wires to the AC terminal block.

8. Insert the remaining four wires through the AC conduit to the inverter, and connect them to the appropriate terminal blocks in the inverter according to the labels on the terminal blocks (N, L1, L2 and L3).

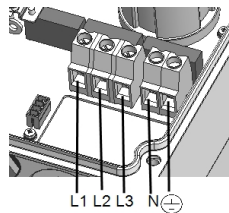

Figure 34: AC Terminals

9. Tighten the screws of each terminal with a torque of 1.2-1.5 N*m / 0.88-1.1 lb*ft.
10. Check that the wires are fully inserted and cannot be pulled out easily.
11. Tighten the AC cable gland with a torque of 5.0 N*m / 44 lb*in.
12. Verify that there are no unconnected wires.
13. Make sure the SPDs are tightly attached to the DIN rail.

NOTE

If power control is enabled, it is important to respect the order of grid lines connection to the inverter. A 120deg phase difference should be kept between L1 to L2 and between L2 to L3 (L1-L2-L3 and not, for example L1-L3-L2).

If the grid lines are not in this order, an error is displayed on the SetApp screen and the inverter will not produce power.

Connecting the Strings to the DC Safety Unit

Up to three strings may be connected in parallel to the DC input pairs of the switch. The terminals are suitable for connection of copper conductors only.

→ **To connect the strings to the DC Safety Unit:**

1. Strip 8 mm of the DC wire insulation.
2. Insert the wires into the DC input glands of the DC Safety Unit .
3. Connect the DC wires according to the DC+ and DC- labels:

- For DC terminals *without fuses*: Use a standard flat-blade screwdriver to connect the wires to the spring-clamp terminals.
 - The screwdriver blade should fit freely in the terminal opening. Too large a blade can crack the plastic housing.
 - Insert the screwdriver and press the release mechanism and open the clamp.
 - Insert the conductor into the round opening and remove the screwdriver – the wire is automatically clamped.

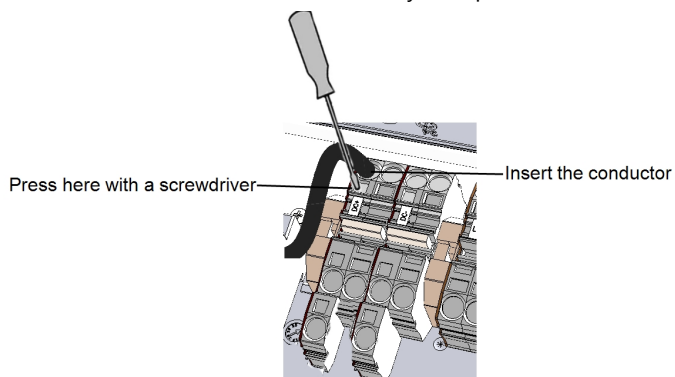

Figure 35: Spring-clamp terminals

- For DC terminals *with fuses*:
 - Insert the wires into the side openings.
 - Fasten the screws at the top of the fuses. Apply torque of 3.4 N*M / 30 lb*in.

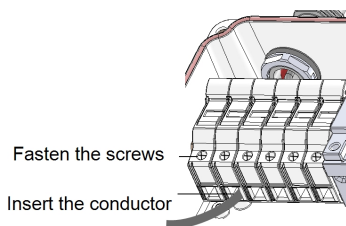

Figure 36: DC connection with fuses

4. Verify that there are no unconnected wires.
5. Close the DC Safety Unit cover: Attach the cover and secure it by tightening the four screws with a torque of 1.2 N*m / 0.9 ft.*lb.

6. Ensure proper cable entry sealing: inspect the entire cable run and use standard sealants to avoid water penetration.

Appendix D: SafeDC™

When AC supply to the inverter is shut off (by shutting off the AC breaker at the site), or when the inverter ON/OFF/P switch is turned to OFF, the DC voltage drops to a safe voltage of 1V per optimizer.

The SolarEdge inverters are certified for compliance with the following standards as disconnection devices for PV generators, meaning that they can replace a DC disconnect:

- IEC 60947-3:1999 + Corrigendum: 1999 + A1:2001 + Corrigendum 1:2001 + A2:2005;
- DIN EN 60947-3
- VDE 0660-107:2006-03
- IEC 60364-7-712:2002-05
- DIN VDE 0100-712:2006-06.

In compliance with these standards, the disconnection mechanism operates as follows:

1. Turn the inverter ON/OFF/P switch, located at the bottom of the inverter, to OFF, or disconnect the AC by shutting off the AC breaker at the site. The DC voltage displayed on the SetApp screen begins to decrease.
2. When the DC voltage reaches a safe voltage, the PV connectors at the input to the inverter can be disconnected. A galvanic separation then exists between the PV array and the inverter.

WARNING!

SafeDC complies with IEC60947-3 when installing the system with a worst case SafeDC voltage (under fault conditions) < 120V.

The worst case voltage is defined as: $V_{oc,max} + (\text{String Length} - 1) * 1V$, where:



- $V_{oc,max}$ = Maximum V_{oc} (at lowest temperature) of the PV module in the string (for a string with multiple module models, use the max value)
 - String Length = number of power optimizers in the string
-

Appendix E: External Fan Maintenance and Replacement

The inverter has two fans: one is internal and the other is accessible from the outside of the inverter.

A fan replacement kit is available from SolarEdge.

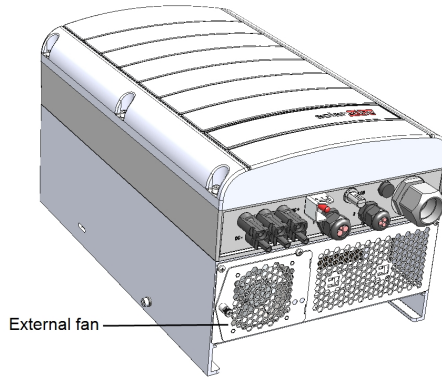

Figure 37: Inverter external fan

Fan Maintenance

At least once a year, open the fan screen and clean the accumulated dust using a brush. If the SetApp Status screen displays the status **Not Working** for the fan (refer to *Main Inverter Status* on page 41), replace the fan as described in the next section.

External Fan Replacement

1. Turn OFF the inverter ON/OFF/P switch, and wait until the green LED is blinking, indicating that the DC voltage is safe (<50V), or wait five minutes before continuing to the next step.
2. Turn OFF the DC Safety Unit(if applicable).
3. Disconnect the AC to the inverter by turning OFF the circuit breakers on the distribution panel.
4. Use a standard screwdriver to unfasten the single screw of the fan cover and open the fan door.

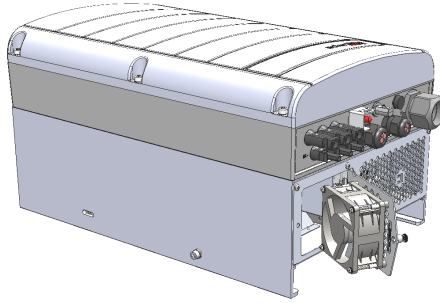

Figure 38: Fan door open

5. Disconnect the fan connector and remove the fan.

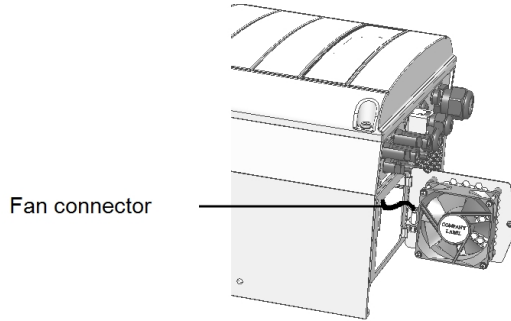
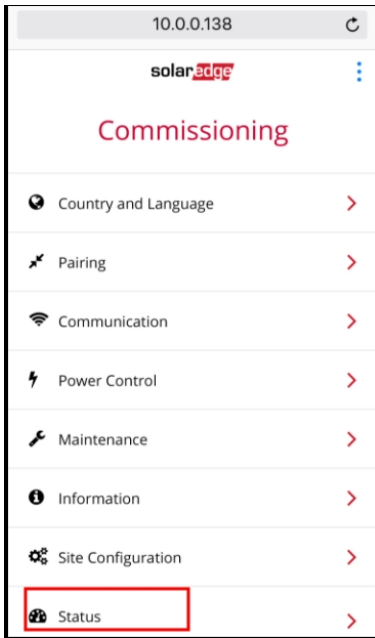

Figure 39: Fan connector

6. Connect the fan connector to the new fan.
7. Close the fan door and fasten the cover screws.

1. After powering up the inverter, check the fan status on SetApp: Select **Commissioning** → **Status**.



Status		
Inverter SN 07318000C		
Power 7.60 kW	Voltage 240 Vac	Frequency 60.9 Hz
P_OK: 30 of 30 Optimizers Connected		S_OK Server Connected (LAN)
Status Production		Switch ON
Cos Phi 1.00	Limit No Limit	Country USA2
Voltage 380 Vdc	Temp. 156 F	Fan OK

Appendix F: Replacing and Adding System Components

This appendix includes replacement procedures for the SolarEdge system components. For inverter or DC Safety Unit replacement, typically only the part to be replaced is supplied (not both inverter and DC Safety Unit). In this case, the DC Safety Unit should be disconnected from the inverter as described herein.

NOTE



If you are permanently disassembling the installation or part of it, make sure to use the disposal methods dictated by local regulations.

CAUTION!



Do not remove the six screws on the DC metal panel as it may harm the inverter sealing and void the warranty.

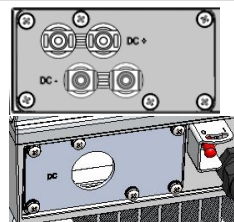

Replacing an Inverter

1. Turn OFF the DC Safety Unit (if applicable).
2. Turn OFF the inverter ON/OFF/P switch, and wait until the green LED is blinking, indicating that the DC voltage is safe (<50V), or wait five minutes before continuing to the next step.
3. Disconnect the AC to the inverter by turning OFF the circuit breakers on the distribution panel.
4. Open the inverter cover as described in *Removing the Inverter Cover* on page 52.
5. Disconnect the DC plugs and AC wires from the inverter.
6. For inverters with a DC Safety Unit, unscrew the two conduit nuts in the inverter securing the DC Safety Unit to the inverter.

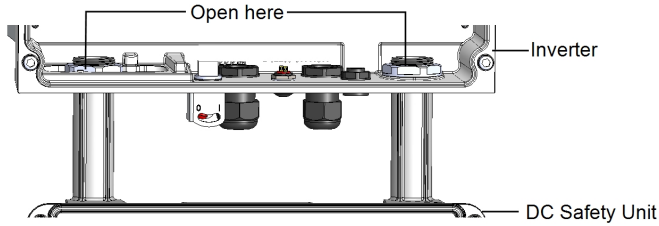

Figure 40: Conduit nuts

- Remove the screws securing the inverter to the mounting bracket and remove the inverter from the mounting bracket.

**NOTE**

If you remove the old inverter and do not immediately install a new one, use insulation tape to isolate each of the AC and DC wires

- Place the new inverter on the mounting bracket; insert the screws securing the inverter to the mounting bracket.
- For inverters with a Connection Unit, screw the two conduit nuts in the inverter securing the DC Safety Unit to the inverter.
- Connect all the wires to the inverter: Follow the instructions of *Installing the Inverter* on page 20 and *Activating, Commissioning and Configuring the System Using the Inverter SetApp* on page 35.
- Close the DC Safety Unit cover (if applicable) and the inverter cover.

Replacing the DC Safety Unit

Removing the DC Safety Unit

- Turn OFF the inverter ON/OFF/P switch, and wait until the green LED is blinking, indicating that the DC voltage is safe (<50V), or wait five minutes before continuing to the next step.
- Turn OFF the DC Safety Unit and the AC breaker of the distribution panel.
- Open the inverter cover.
- Disconnect the DC and AC wires from the inverter. If there are ferrite beads on the DC and AC wires in the inverter, open them and set aside.
- Disconnect the RS485 connector from the inverter communication board.

6. Unscrew the two conduit nuts in the inverter securing the DC Safety Unit to the inverter, as shown below:

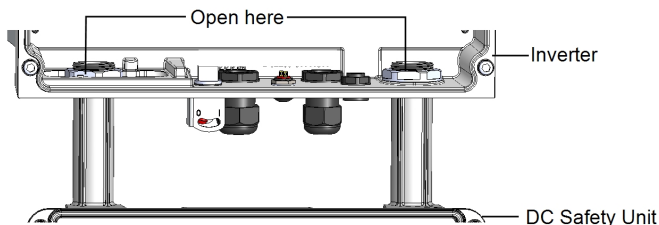

Figure 41: Disconnecting the conduits

7. Open the DC Safety Unit cover and disconnect the DC and AC wires. Unscrew the two conduit nuts securing the DC Safety Unit to the external conduits.
8. If the DC Safety Unit bracket is screwed to the wall, release it.
9. Carefully remove the DC Safety Unit with its mounting bracket from the wall.

Installing a New DC Safety Unit

1. Open the conduit drill guides of the new DC Safety Unit.
2. Position the new DC Safety Unit below the inverter and from the inside of the inverter grab the AC and DC wires extending from the switch conduits.
3. Attach the DC Safety Unit with its bracket to the wall and slightly close the screws. Do not over tighten.
4. Securely screw the two conduit nuts onto the conduit ends in the inverter. Verify proper conduit sealing.

Connecting the DC Safety Unit to the Inverter

1. If ferrite beads were removed from the DC and AC wires, place them on the wires and close them. Make sure the DC labeled ferrite bead is placed on the DC wires and the AC labeled ferrite bead is placed on the AC wires.
2. Connect the DC, as follows:
 - Connect the red wire to any of the DC+ terminals in the inverter.
 - Connect the black wire to any of the DC- terminals in the inverter.

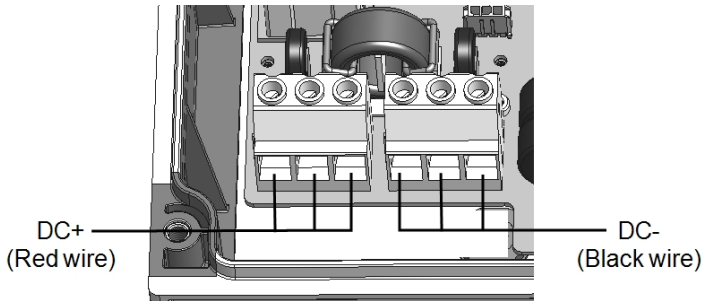

Figure 42: DC terminals

3. Connect the AC wires according to the labels on the AC terminal blocks, as follows:

Wire type	Connect to terminal
Line 1	L1
Line 2	L2
Line 3	L3
PE (grounding)	
Neutral	N

Figure 43: AC terminals

4. Tighten the screws of each terminal with a torque of 1.2-1.5 N*m / 0.88-1.1 lb.*ft.
5. Verify that there are no unconnected wires at the output of the DC Safety Unit and that any unused terminal screws are tightened.
6. Connect the DC and AC wires to the DC Safety Unit. Refer to *Connecting the AC and the Strings to the Inverter* on page 30.
7. Ensure proper cable entry sealing; inspect the entire cable run and use standard sealants to avoid water penetration.

Adding, Removing, or Replacing Power Optimizers

1. Turn OFF the inverter ON/OFF/P switch, and wait until the green LED is blinking , indicating that the DC voltage is safe (<50V), or wait five minutes before continuing to the next step.
2. Disconnect the AC to the inverter by turning OFF the circuit breakers on the distribution panel.
3. Turn OFF the DC Safety Unit (if applicable).
4. Disconnect and connect the necessary power optimizers.
5. Perform pairing and other procedures described in *Activating, Commissioning and Configuring the System Using the Inverter SetApp* on page 35 on all inverters to which power optimizers were added or from which power optimizers were removed.
6. In the monitoring platform, use the **Replace** button in the **logical layout** tab (in site Admin). Replace the serial number of the removed power optimizer with the serial number of the newly installed power optimizer. Refer to <https://www.solaredge.com/sites/default/files/se-monitoring-portal-site-admin.pdf>



Appendix G: Determining the Circuit Breaker Size

Size

Revision History

- Version 1.0 February 2019: first release

Introduction

Inverters should be protected by circuit breakers. This document describes how to determine which circuit breaker to use in three phase commercial installations.

Using Transformers in Commercial Three Phase Inverter Installations

Using transformers in a commercial installation is optional. In most cases a transformer is used to connect the installation to the medium voltage power grid. The following figure illustrates a typical transformer and commercial three phase inverter installation topology.

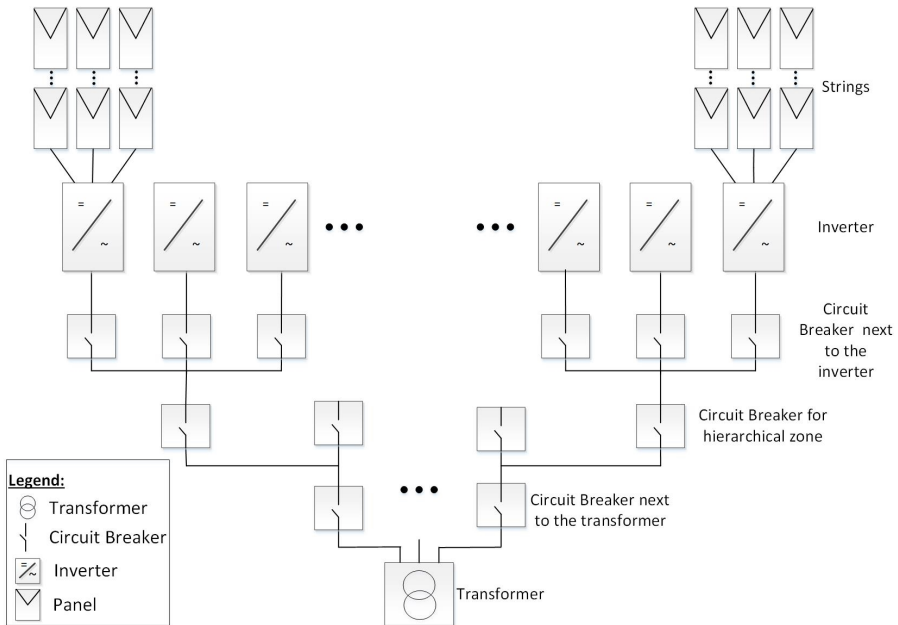

Figure 44: Typical transformer and commercial three phase inverter installation topology

There are many considerations for selecting the suitable transformer and its associated current limiting devices such as circuit breakers and fuses. The considerations must include at least the following:

- The transformer should be designed for a typical PV system production profile: high daytime loads with no loads at night.
- The current limiting devices should protect the electrical circuits and the inverters from the excess current created by an overload, or a short circuit. If a short circuit or other overcurrent occurs, the current limiting devices should block the current flow to the circuit, thus preventing damage to the electrical circuits and the inverters.

The circuit breakers and the fuses should comply with the transformer manufacturer recommendations and with the relevant sections in standards such as IEC 60909, IEC 60364, UL 508A and NEC 2017.

Some manufacturers provide detailed information about the transformer short circuit calculation procedure, and its effect on the selection of circuit breakers and fuses at the different hierarchical levels of the installation topology (see *Figure 4A*).

For an example of a calculation, refer to:

- [Guidelines on the Short Circuit Current Rating for Industrial Control Panels](#)
 - [Short-circuit current rating \(SCCR\) of industrial control panels](#)
- To ensure that the circuit breaker and fuses trip as expected, follow their manufacturers' recommendations, especially with respect to the various de-rating considerations.

NOTE



Transformer procurement, installation, maintenance and support are the responsibility of the installer. Damage to the inverter due to incorrect transformer installation, or use of a transformer that is incompatible with the SolarEdge system will render the SolarEdge warranty invalid.

NOTE



Transformer procurement, installation, maintenance and support are the responsibility of the installer. Damage to the inverter due to incorrect transformer installation, or use of a transformer that is incompatible with the SolarEdge system will render the SolarEdge warranty invalid.

Determining the Size of an Inverter Circuit Breaker

This section explains how to determine the rate of a circuit breaker next to an inverter. For an example of an inverter with a circuit breaker next to it see *Figure 44*.

Ensure you have the following parameters before determining the circuit breaker size:

- The inverter's maximum continuous output current as appears in the datasheet.
- Factor for the installation's country. This factor is dictated by regulation, applicable standards or common practice and is usually 1.25.

→ To determine the size of an inverter circuit breaker:

1. Multiply the inverter's maximum continuous output current by the factor.
For example, $40A \times 1.25 = 50A$
2. Round up the rated size, as calculated in step 1, to the closest standard circuit breaker size. See Circuit Breaker Criteria table below for standard sizes suitable for SolarEdge three phase inverters.



NOTE

If the result has a decimal fraction smaller than 0.5 round it down.

3. To ensure that the selected circuit breaker trips as expected, at minimum consider the following:
 - The circuit breaker rated voltage.
 - Temperature de-rating due to both close proximity of other circuit breakers and the effect of ambient temperature on the distribution board.
 - De-rating due to permanent load.

If the de-rated current of the selected circuit breaker is lower than the maximum output current of the inverter, consider selecting a circuit breaker that is designed for a higher rated current, or reducing the temperature de-rating effect by increasing the distance between adjacent circuit breakers.

NOTE



- Make sure to select cables that are suitable for the environmental conditions, the operating voltage and the selected circuit breaker.
- Three or four pole circuit breakers are required. It is recommended to use a four pole circuit breaker when applicable.
- It is recommended to use a circuit breaker with tripping characteristic B or C.

Table 1: Circuit Breaker Criteria

Inverter	Max. Continuous Output Current (per Phase)	Recommended Circuit Breaker
SE12.5K	20A	25A
SE14.4KUS	40A	50A
SE15K	23A	32A
SE16K	25.5A	32A
SE17K	26A	32A
SE25K	38A	50A
SE27.6K	40A	50A
SE30K	36.5A	50A
SE33.3K	40A	50A
SE43.2KUS	120A	150A
SE50K	76A	100A
SE55K	80A	100A
SE66.6K	80A	100A
SE66.6KUS	80A	100A
SE75K	120A	150A
SE82.8K	120A	150A
SE100K	120A	150A
SE100KUS	120A	150A

Technical Specifications - Three Phase Inverters (Europe & APAC)

SE4K - SE12.5K

	SE4K	SE5K	SE7K	SE8K	SE9K	SE10K	SE12.5K	Unit
Output								
Rated AC power output	4000 ⁽¹⁾	5000	7000	8000	9000	10000	12500	VA
Maximum AC power output	4000	5000	7000	8000	9000	10000	12500	VA
AC Output Line Connections	3 phase, 4-wire / PE (L1-L2-L3-N), TN, TT							
AC output voltage – line to line / line to neutral (nominal)	380/ 220; 400/ 230							Vac
AC output voltage range	184 – 264.5							Vac
AC frequency	50/60 ± 5							Hz
Maximum continuous output current (per phase)	6.5	8	11.5	13	14.5	16	20	A
Maximum continuous overcurrent protection	6.5	8	11.5	13	14.5	16	20	A
Residual current detector / Residual Current step detector	300 / 30							mA
Grid supported – three phase	3 / N / PE (WYE with Neutral)							
Inrush current AC (Peak/Duration)	3/ 20							Aac (rms) / ms
Maximum output fault current	33							A
Power factor range	1 (adjustable from -0.9 to +0.9)							

⁽¹⁾SE4K model is available in some countries; refer to the Certifications category in

<http://www.solaredge.com/groups/support/downloads>

	SE4K	SE5K	SE7K	SE8K	SE9K	SE10K	SE12.5K	Unit
Total harmonic distortion	< 3%							
Protective class	Class I							
Utility monitoring, islanding protection, configurable Power Factor, country configurable thresholds	Yes							
Overvoltage category	III							
Input								
Maximum DC power (Module STC)	5400	6750	9450	10800	12150	13500	16850	W
Transformer-less, ungrounded	Yes							
Maximum input voltage	900							Vdc
Nominal DC input voltage	750							Vdc
Maximum input current	7	8.5	12	13.5	15	16.5	21	Adc
Maximum back-feed current	0							Adc
Reverse-polarity protection	Yes							
Ground-fault isolation detection	700kΩ Sensitivity							
Overvoltage category	II							
Maximum inverter efficiency	98							%
European weighted efficiency	97.3	97.3	97.3	97.5	97.5	97.6	97.7	%
Night-time power consumption	< 2.5							W

	SE4K	SE5K	SE7K	SE8K	SE9K	SE10K	SE12.5K	Unit
Additional Features								
Supported communication interfaces	2 x RS485, Ethernet, Built-in GSM (Optional)							
Inverter commissioning	With the SetApp mobile application using built-in Wi-Fi station for local connection							
RS485 Surge Protection	Supplied with the inverter							
Smart Energy Management	Export Limitation							
Arc Fault Protection	Integrated, user configurable (according to UL1699B)							
Standard Compliance								
Safety	IEC-62103 (EN50178), IEC-62109							
Grid connection standards ⁽¹⁾	VDE 0126-1-1, VDE-AR-N-4105, AS-4777, G83 / G59							
Emissions	IEC61000-6-2, IEC61000-6-3, IEC61000-3-11, IEC61000-3-12, FCC part15 class B							
WEEE, RoHS	Yes							
Installation Specifications								
AC output / Gland Diameter / Wire Cross Section	15-21 mm / Solid wire 2.5-16 mm ² , Stranded wire 2.5 - 10 mm ²							
DC input	2 MC4 pairs ⁽²⁾							
Dimensions (WxLxH)	540 x 315 x 260							mm
Weight	33.2							kg
Operating temperature range ⁽³⁾	-40 - +60							°C
Operating humidity – non condensing	< 95							%
Cooling	Fan (user replaceable)							

(1) For all standards refer to the Certifications category in

<http://www.solaredge.com/groups/support/downloads>.

(2) You can connect strings in parallel to a single input as long as the cumulative current does not exceed 45A.

(3) For inverter power de-rating refer to the application note at the following link:

<http://www.solaredge.com/files/pdfs/se-temperature-derating-note.pdf>

	SE4K	SE5K	SE7K	SE8K	SE9K	SE10K	SE12.5K	Unit
Noise (typical)	< 50 ⁽¹⁾							dBA
Protection rating/ Environmental category	IP65 - Outdoor and indoor							
Maximum altitude	2000							m
Pollution degree classification (inside/outside)	2/3							
Bracket mounted (bracket provided)								

SE15K - SE33.3K⁽²⁾

	SE15K	SE16K	SE17K	SE25K	SE27.6K	SE33.3K	Unit
Output							
Rated AC power output	15000	16000	17000	25000 ⁽³⁾	27600	33300	VA
Maximum AC power output	15000	16000	17000	25000 ⁶	27600	33300	VA
AC Output Line Connections	3 phase, 4-wire / PE (L1-L2-L3-N), TN, TT						
AC output voltage – line to line / line to neutral (nominal)	380/ 220; 400/ 230					480/277	Vac
AC output voltage range	184 – 264.5					244-305	Vac
AC frequency	50/60 ± 5						Hz
Maximum continuous output current (per phase)	23	25.5	26	38	40	40 @277V	A
Maximum continuous overcurrent protection	23	25.5	26	38	40	40	A

(1) For inverters with a noise level suitable for residential environments refer to:

<http://www.solaredge.com/files/pdfs/products/inverters/se-three-phase-indoor-inverter-datasheet.pdf>

(2) The SE33.3K model requires a medium voltage transformer.

(3) 24.99kVA in the UK

	SE15K	SE16K	SE17K	SE25K	SE27.6K	SE33.3K	Unit
Residual current detector / Residual Current step detector	300 / 30						mA
Grid supported – three phase	3 / N / PE (WYE with Neutral)						V
Inrush current AC (Peak/ Duration)	3/ 20			3.1/ 20		4.2/ 20	Aac (rms) / ms
Maximum output fault current	40			63			A
Power factor range	1 (adjustable from -0.9 to +0.9)			1 (adjustable from -0.8 to +0.8) ⁽¹⁾			
Total harmonic distortion	< 3%						
Protective class	Class I						
Utility monitoring, islanding protection, configurable Power Factor, country configurable thresholds	Yes						
Overvoltage category	III						
Input							
Maximum DC power (Module STC)	20250	21600	22950	33750	37250	45000	W
Transformer-less, ungrounded	Yes						
Maximum input voltage	900				1000		Vdc
Nominal DC input voltage	750				840		Vdc
Maximum input current	22	23	23	37	40	40	Adc
Maximum back-feed current	0						Adc
Reverse-polarity protection	Yes						

(1) For SE27.6K - when set to Germany Power Factor is limited to 0.9.

	SE15K	SE16K	SE17K	SE25K	SE27.6K	SE33.3K	Unit
Ground-fault isolation detection	700 k Ω Sensitivity			350 k Ω Sensitivity ⁽¹⁾			
Overvoltage category	III						
Maximum inverter efficiency	98			98.3		98.1	%
European weighted efficiency	97.6	97.7		98			%
Night-time power consumption	< 2.5			< 4			W
Additional Features							
Supported communication interfaces	2 x RS485, Ethernet, Built-in GSM (Optional)						
Inverter commissioning	With the SetApp mobile application using built-in Wi-Fi station for local connection						
RS485 Surge Protection	Supplied with the inverter						
Smart Energy Management	Export Limitation						
Arc Fault Protection	Integrated, user configurable (according to UL1699B)						
Rapid Shutdown	Optional ⁽²⁾ (Automatic upon AC grid disconnect)						
DC Safety Unit (optional)							
2-pole Disconnection	N/A			1000V / 40A			
DC Surge Protection	N/A			Type II, field replaceable			
DC Fuses on Plus & Minus	N/A			Optional, 20A			
Compliance	N/A			UTE-C15-712-1			
Standard Compliance							
Safety	IEC-62103 (EN50178), IEC-62109, AS3100						
Grid connection standards ⁽³⁾	VDE-AR-N-4105, G59/3, AS-4777, EN 50438, VDE 0126-1-1, CEI-021, BDEW, CEI-016 ⁽⁴⁾ ;						

(1)Where permitted by local regulations

(2)Inverter with rapid shutdown part number: SExxK-RWROOBNN2; available for SE25K and SE27.6K

(3)For all standards refer to the Certifications category in <http://www.solaredge.com/groups/support/downloads>.

(4)Models SE25K, SE27.6K and SE33.3K only

	SE15K	SE16K	SE17K	SE25K	SE27.6K	SE33.3K	Unit
Emissions	IEC61000-6-2, IEC61000-6-3, IEC61000-3-11, IEC61000-3-12						
WEEE, RoHS	Yes						
Installation Specifications							
AC output / Gland Diameter / Wire Cross Section	15-21 mm / Solid wire 2.5-16 mm ² , Stranded wire 2.5 - 10 mm ²			18-25mm / Solid wire 2.5-16 mm ² , Stranded wire 2.5-10 mm ²			
DC input ⁽¹⁾	2 MC4 pairs			3 MC4 pairs			
DC input with DC Safety Unit	N/A			Gland diameter 5-10 mm			mm
				Wire cross section 0.5 - 13.5			mm ²
Dimensions (HxWxD)	540 x 315 x 260						mm
Dimensions with Safety Unit (HxWxD)	N/A			775 x 315 x 260			mm
Weight	33.2			45			kg
Weight with Safety Unit	N/A			48			kg
Operating temperature range ⁽²⁾	-40 - +60						°C
Operating humidity – non condensing	< 95						%
Cooling	Fan (user replaceable)						
Noise (typical)	< 50			< 55			dBA
Protection rating/ Environmental category	IP65 Outdoor and indoor						
Maximum altitude	2000						m
Pollution degree classification (inside/ outside)	2/3						
Bracket mounted (bracket provided)							

(1) Connection of additional strings in parallel to a single input is allowed as long as the cumulative current does not exceed 45A.

(2) For inverter power de-rating information, refer to the application note at the following link:

<http://www.solaredge.com/files/pdfs/se-temperature-derating-note.pdf>

If you have technical queries concerning our products, please contact our support through SolarEdge service portal: www.solaredge.com/service/support

Australia (+61)	1800 465 567
APAC (Asia Pacific)(+972)	073 240 3118
Belgium (+32)	0800-76633
Netherlands (+31)	0800-7105
China (+86)	21 6212 5536
DACH & Rest of Europe (+49)	089 454 59730
France (+33)	0800 917410
Italy (+39)	0422 053700
Japan (+81)	03 6262 1223
New Zealand (+64)	0800 144 875
US & Canada (+1)	510 498 3200
United Kingdom (+44)	0800 028 1183
Republic of Ireland (+353)	1-800-901-575
Greece (+49)	89 454 59730
Israel (+972)	073 240 3122
Middle East & Africa (+972)	073 240 3118
South Africa (+27)	0800 982 659
Turkey (+90)	216 706 1929
Worldwide (+972)	073 240 3118