

# Installation Instruction

## AXIstorage Li SV1



This manual introduces the AXIstorage Li SV1 from Axitec. Please read this manual before you install the battery and follow the instructions carefully during the installation process. If there is any confusion, please contact Axitec immediately for advice and clarification.

## Content

<b>1. SAFETY</b> .....	<b>1</b>
1.1 Symbol explanation.....	2
1.2 Before Connecting .....	5
1.3 While Using.....	5
<b>2. SYSTEM INTRODUCTION</b> .....	<b>6</b>
2.1 Product Introduction.....	6
2.2 Specifications.....	7
2.2.1 System parameter .....	7
2.2.2 Battery Module (Energypack SV1).....	8
2.2.3 Control Module BMS SV1 (internal power supply) .....	9
2.3 System Diagram .....	12
<b>3. INSTALLATION</b> .....	<b>13</b>
3.1 Required Tools.....	13
3.2 Safety Gear.....	13
3.3 System Working Environment Checking.....	14
3.3.1 Cleaning.....	14
3.3.2 Ventilation.....	14
3.3.3 Fire-extinguisher System .....	14
3.3.4 Grounding System .....	14
3.3.5 Clearance.....	14
3.4 Handling and placement.....	14
3.4.1 Handling and placement of the battery modules .....	14
3.4.2 Handling and placement of the base .....	15
3.4.3 Selection of installation sites .....	15
3.4.4 Packing list .....	15
3.4.5 Mounting and installation of the base.....	16
3.4.6 Battery Modules and Control Module (BMS) pile up .....	17
3.4.7 Installation of the metal mounting rails.....	18
3.4.8 Locking of the control Module's fix screw on left and right side .....	20
3.5 Cables connection.....	21
3.5.1 Grounding.....	21
3.5.2 Cables.....	22
3.6 Connection to Inverter .....	23
3.7 Switching on the System .....	23
3.8 Switching the System off .....	25
3.9 Online Monitoring.....	25

---

<b>4.</b>	<b>SYSTEM DEBUG .....</b>	<b>26</b>
<b>5.</b>	<b>MAINTENANCE .....</b>	<b>27</b>
	5.1 Trouble Shooting:.....	27
	5.2 Replacement of main components.....	28
	5.2.1 Replacement of Battery Module .....	28
	5.2.2 Replacement of Control Module (BMS) .....	30
	5.3 Battery Maintenance.....	31
<b>6.</b>	<b>REMARKS .....</b>	<b>32</b>
<b>7.</b>	<b>SHIPMENT .....</b>	<b>32</b>
	<b>ANNEX 1: INSTALLATION AND SYSTEM TURN ON PROGRESS LIST .....</b>	<b>33</b>
	<b>ANNEX 2: SYSTEM TURN OFF PROGRESS LIST .....</b>	<b>34</b>

## 1. Safety

The AXIstorage Li SV1 is a high voltage DC system, operated by skilled/qualified personnel only. Read all safety instructions carefully prior to any work and observe them at all times when working with the system.

### **Incorrect operation or work may cause:**

- injury or death to the operator or a third party;
- damage to the system hardware and other properties belonging to the operator or a third party.









### **Skills of Qualified Personnel**

Qualified personnel must have the following skills:

- training in the installation and commissioning of the electrical system, as well as for dealing with hazards;
- knowledge of this manual and other related documents;
- knowledge of the local regulations and directives.

### 1.1 Symbol explanation

	<p><b>Danger</b></p>	<p><b>Lethal voltage!</b></p> <ul style="list-style-type: none"> <li>● Battery strings will produce HIGH DC power and can cause a lethal voltage and an electric shock.</li> <li>● Only a qualified person can perform the wiring of the battery strings.</li> </ul>
	<p><b>Warning</b></p>	<p><b>Risk of battery system damage or personal injury</b></p> <ul style="list-style-type: none"> <li>● DO not pull out the connectors while the system is working!</li> <li>● De-energize from all power sources and verify that there is no voltage.</li> </ul>
	<p><b>Caution</b></p>	<p><b>Risk of battery system failure or life cycle reduction.</b></p>
	<p>Symbol in label</p>	<p><b>Read the product and operation manual before operating the battery system!</b></p>
	<p>Symbol in label</p>	<p><b>General warning</b></p>
	<p>Symbol in label</p>	<p><b>Warning electric shock!</b></p>
	<p>Symbol in label</p>	<p><b>Warning against flammable substances</b></p>
	<p>Symbol in label</p>	<p><b>Do not reverse connect the positive and negative potential.</b></p>

	<p>Symbol in label</p>	<p><b>Do not place near open flame</b></p>
	<p>Symbol in label</p>	<p><b>Do not place in an area accessible for children and pets.</b></p>
	<p>Symbol in label</p>	<p><b>Recycle label.</b></p>
	<p>Symbol in label</p>	<p><b>Label for Waste Electrical and Electronic Equipment (WEEE) Directive (2012/19/EU)</b></p>
	<p>Symbol in label</p>	<p><b>Symbol of CE-conformity</b></p>
	<p>Symbol in label</p>	<p><b>The certificate label for Safety by TÜV SÜD.</b></p>
	<p>Symbol in label</p>	<p><b>The certificate label for Safety by TÜV Rheinland.</b></p>
	<p>Symbol in label</p>	<p><b>The certificate label for Safety by TÜV Rheinland.</b></p>



**Danger:** Batteries deliver electric power, resulting in burns or fire hazard when they are short circuited, or wrongly installed.

**Danger:** Lethal voltages are present at the battery terminals and cables. Severe injuries or death may occur if the cables and terminals are touched.



**Warning:** DO NOT open or deform the battery module, otherwise the product will be out of warranty scope

**Warning:** Whenever working on the battery, wear suitable personal protective equipment (PPE) such as rubber gloves, rubber boots and goggles.

**Warning:** The AXIstorage Li SV1 system's working temperature range: 0°C ~ 50°C; Optimum temperature: 18°C~28°C. Conditions out of the working temperature range may cause the battery system over / low temperature alarm or protection which further leads to a cycle life reduction as well as it will affect the warranty terms.



**Warning:** For battery installation, the installer shall refer to NFPA70 or similar local installation standard for operation.



**Caution:** Improper settings or maintenance can permanently damage the battery.

**Caution:** Incorrect inverter parameters will lead to a further faulty/damaged battery.



#### Reminding

- 1) It is very important and necessary to read the user manual carefully before installing or using the battery. Not doing so or not to follow any of the instructions or warnings in this document can result in electrical shock, serious injury, or death, or can damage the battery, potentially rendering it inoperable.
- 2) If the battery is stored for a long time, it is required to charge them every six months, and the SOC should be no less than 90%;
- 3) Batteries need to be recharged within 12 hours, after full discharge;
- 4) Do not expose cable outside;



### 1.2 Before Connecting

- 1) After unpacking, please check the product and packing list first. If a product is damaged or if there is a lack of parts, please contact the local retailer;
- 2) Before installation, be sure to cut off the grid power and make sure the battery is in the switched-off mode;
- 3) Wiring must be correct, do not mistake the positive and negative cables, and ensure there is no short circuit with the external device;
- 4) It is prohibited to connect the battery to AC power directly;
- 5) The Battery system must be well grounded, and the resistance must be less than 100mΩ;
- 6) Please ensured the electrical parameters of the battery system are compatible to the related equipment;
- 7) Keep the battery away from water and fire.



### 1.3 While Using

- 1) If the battery system needs to be moved or repaired, the power must be cut off and the battery is completely shut down;
- 2) It is prohibited to connect the battery with a different type of battery.
- 3) It is prohibited to use the batteries with a faulty or incompatible inverter;
- 4) It is prohibited to disassemble the battery (QC tab removed or damaged);
- 5) In case of fire, only dry powder fire extinguisher can be used, liquid fire extinguishers are prohibited;



## 2. System Introduction

### 2.1 Product Introduction

The AXIstorage Li SV1 is a high voltage battery storage system based on lithium iron phosphate batteries, which is a new energy storage product of Axitec. It can be used to provide reliable power for various types of equipment and systems. AXIstorage Li SV1 is especially suitable for those application which require high power output, limited installation space, restricted load-bearing and long cycle life.



## 2.2 Specifications

### 2.2.1 System parameter

Product Type	AXIstorage Li SV1				
Cell Technology	Li-iron (LFP)				
Battery System Capacity(kWh)	10.65	14.20	17.76	21.31	24.86
Battery System Voltage(Vdc)	144	192	240	288	336
Battery System Capacity(AH)	74Ah				
Battery Controller Name	BMS SV1				
Battery Module Name	Energy pack SV1				
Battery Module Quantity(pcs)	3	4	5	6	7
Battery Module Capacity(kWh)	3.552				
Battery Module Voltage(Vdc)	48				
Battery Module Capacity(AH)	74				
Battery System Charge Upper Voltage(Vdc)	162	216	270	324	378
Battery System Charge Current(Amps, Standard)	14.8				
Battery System Charge Current(Amps, Normal)	37				
Battery System Charge Current(Amps, Max.@15s)	40				
Battery System Discharge Lower Voltage(Vdc)	130.5	174	217.5	261	304.5
Battery System Discharge Current(Amps, Standard)	14.8				
Battery System Discharge Current(Amps, Normal)	37				
Battery System Discharge Current(Amps, Max.@15s)	40				
Short circuit rating(Amps)	<4000				
Efficiency(%)	96				
Depth of Discharge(%)	95				
Dimension(W*D*H) [mm]	600*380* 700	600*380* 870	600*380* 1040	600*380* 1210	600*380* 1380
Communication	CANBUS/Modbus RTU				
Protection Class	IP55				
Weight [kg]	122	158	194	230	266
Operation Temperature(°C)	0~50°C				
Storage Temperature(°C)	-20~60°C				
Altitude(m)	<2000				
Humidity	5~95%				
Product Certificate	VDE2510-50, IEC62619, UL1973, IEC62477-1, IEC62040-1, CEC, CE				
Transport Certificate	UN38.3				
1) Battery Controller Dimensions (W*D*H)	600×380×150mm				
2) Battery Module Dimensions (W*D*H)	600×380×170mm				
3) Battery bottom base Dimensions (W*D*H)	600×380×40mm				

### 2.2.2 Battery Module (Energypack SV1)

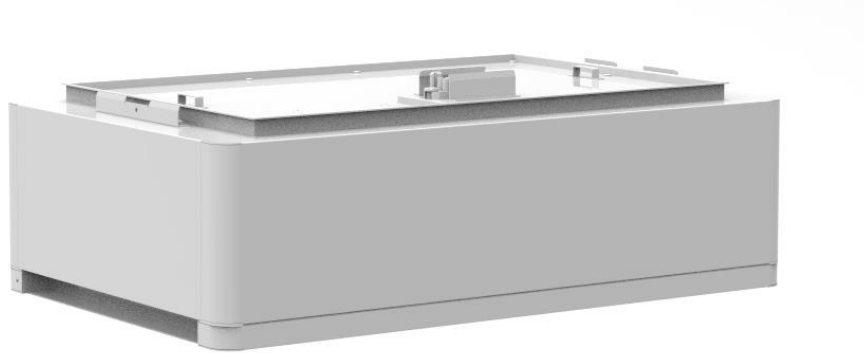

Product Type	Energypack SV1
Cell Technology	Li-ion (LFP)
Battery Module Capacity (kWh)	3.552
Battery Module Voltage (Vdc)	48
Battery Module Capacity (Ah)	74
Battery Module Serial Cell Quantity (pcs)	15
Battery Cell Voltage (Vdc)	3.2
Battery Cell Capacity (AH)	37
Dimension (W*D*H, mm)	600*380*170
Weight (kg)	36
Operation Temperature	0~50°C
Storage Temperature	-20~60°C
Transport Certificate	UN38.3

**2.2.3 Control Module BMS SV1 (internal power supply)**



**Control Module (BMS SV1) Display Panel**

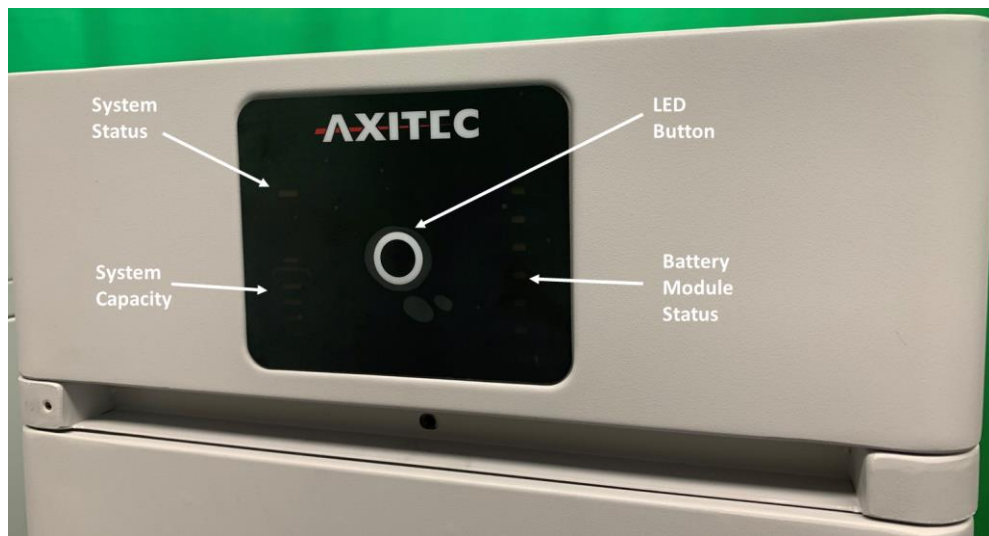

**LED Button**

	Short Press	activates the LED panel for 20sec.
	Long Press (more than 5sec)	When status LED is fast flashing blue ●, release the button, then the baud rate of RS485 is 115200.
		When status LED is fast flashing orange ●, release the button, then the baud rate of RS485 is 9600.

**Status**

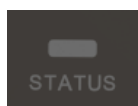

2 colors, blue and orange  
Refer to [LED Indicators Instructions]

### Battery Module Status

	Blue solid	Normal
	Orange solid	Individual module alarm or protection. See trouble shooting steps in section 5.1

### System Capacity



System SOC  
Each LED indicates 25%SOC

### LED Indicators Instructions

Condition			Note
Self-checking	Blue, Flashing	All flashing	
Self-checking failure	Orange, slow flashing	Off	Battery Module Status off. See trouble shooting steps in section 5.1
Black start success	Blue, fast flashing	Off	
Black start failure	Orange, fast flashing	Off	See trouble shooting steps in section 5.1
Communication Lost or BMS error	Orange, solid	Indicate SOC, blue, solid	See trouble shooting steps in section 5.1
Idle	Blue, slow flashing	Indicate SOC, blue, solid	
Charge	Blue, solid	Indicate SOC, blue, solid	
Floating charge	Blue, solid	All flashing, horse race lamp	
Discharge	Blue, flashing	Indicate SOC, blue, solid	
System sleep	Blue, flashing	Off	Battery module status off

**Remark:** Slow flashing: 2.0s ON/1.0s OFF; Flashing 0.5s ON/0.5s OFF; Fast flashing: 0.1s ON/0.1s OFF

## Control Module (BMS SV1) Cable Panel

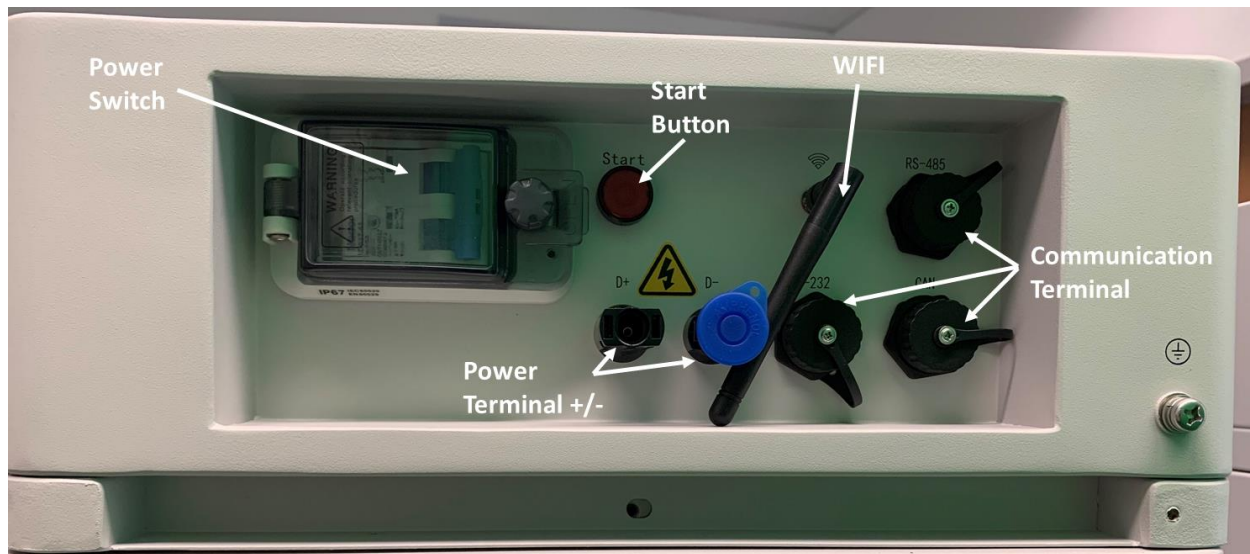

### Power Switch

ON: main breaker ON, it is now possible to turn on the battery system by start button.  
OFF: system turns off completely, no power output.

**Caution:** When the breaker is tripped off because of over current or short circuit, wait at least 30min before turning on again, otherwise it may cause damage to the breaker.

### Start

Start function: press more than 5sec until the buzzer rings, to turn on the controller.

Black start function: when the system is switched on, and the relay is OFF, press more than 10sec, and the relay will turn on for 10 min without communication (depending on conditions).

### WiFi

Wireless maximum output power: 20dBm

Operating frequency: 2412-2472MHz

Gain of antenna: Max 3dBi

Modulation system:

DBPSK/DQPSK/CCK(DSSS)

BPSK/QPSK/16QAM/64QAM(OFDM)

Modulating Repetition:

1Mbps/2Mbps/5.5Mbps/11Mbps(DSSS)

6Mbps/9 Mbps/12 Mbps/18 Mbps/24 Mbps/36 Mbps/48 Mbps/54 Mbps(OFDM)

MCS0~MCS7(802.11n 20MHz)

Channel spacing:5MHz

Type of antenna: 2.4G IPEX-SMA Antenna

### Power Terminal (+/-)

For connecting the power cables between battery system and Inverter.

### Communication Terminal (RS485 / CAN / RS232)

RS485 Communication Terminal: (RJ45 port) follow MODBUS 485 protocol, for communication between battery system and inverter.

CAN Communication Terminal: (RJ45 port) follow CAN protocol, for communication between battery system and inverter.

RS232 Communication Terminal: (RJ45 port) for manufacturer or professional engineer for debugging or service.

### Definition of RJ45 Port Pin

No.	CAN	RS485	RS232
1	---	---	---
2	GND	---	---
3	---	---	TX
4	CANH	---	---
5	CANL	---	---
6	---	---	RX
7	---	RS485A	---
8	---	RS485B	---

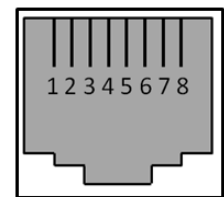

RJ45 Port



RJ45 Plug

### 2.3 System Diagram

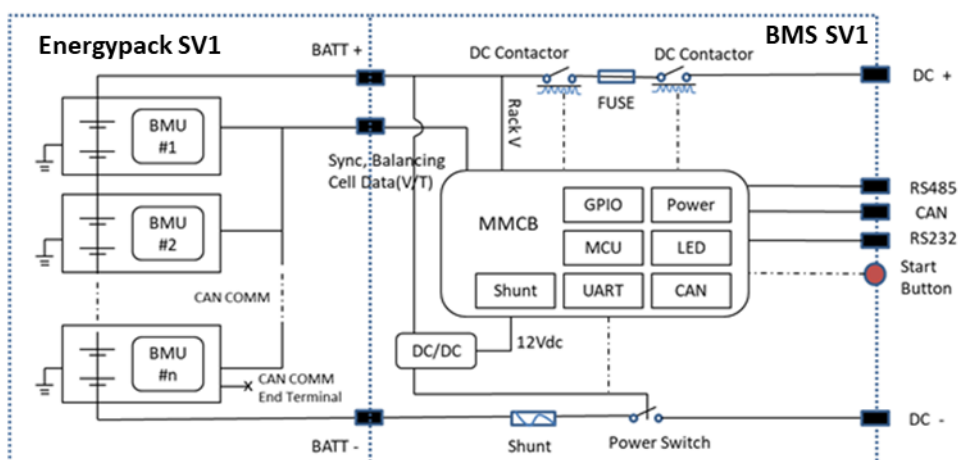

### 3. Installation

#### 3.1 Required Tools

The following tools are required to install the battery pack:

 <p><b>Wire Cutter</b></p>	 <p><b>Crimping Modular Plier</b></p>	 <p><b>Cable Ties</b></p>
 <p><b>Screwdriver Set</b></p>	 <p><b>Electric Screwdriver</b></p>	 <p><b>600VDC Multimeter</b></p>
 <p><b>Adjustable Wrench</b></p>	 <p><b>Sleeve Piece</b></p>	

**NOTE**

Use properly insulated tools to prevent accidental electric shocks or short circuits. If insulated tools are not available, cover the entire exposed metal surfaces, except their tips, with available insulated alternatives (insulating tape).

#### 3.2 Safety Gear

It is recommended to wear the following safety gear when dealing with the battery pack



**Insulated gloves**



**Safety goggles**



**Safety shoes**



### 3.3 System Working Environment Checking

#### 3.3.1 Cleaning



Before installing and switching system power on, the dust and iron scurf must be removed to keep a clean environment.

The system cannot be installed in a desert area without an enclosure to protect it from sand.



**Danger:** Each Battery module has active DC power at its terminal all the time, be careful when handling the modules.

#### 3.3.2 Ventilation



AXIstorage Li SV1 system's working temperature range: 0°C~50°C; Optimum temperature: 18°C~28°C.

There are no mandatory ventilation requirements for the battery modules, but please avoid installations in confined area. The aeration shall avoid high salinity, humidity or temperature.

**Caution:** The AXIstorage Li SV1 system has IP55 protection. But please avoid frost or direct sunlight. Conditions out of the working temperature range will cause the battery systems over / low temperature alarm or protection trigger which further leads to cycle life reduction. If it is necessary due to the environment, a cooling system or heating system should be installed.

#### 3.3.3 Fire-extinguisher System



It must be equipped with fire-extinguisher system for safety purpose.

The fire-extinguisher system needs to be regularly checked to be in normal condition. Refer to the using and maintenance requirements and please follow the local fire equipment guidance.

#### 3.3.4 Grounding System



Before installing the battery make sure the grounding point of the basement is stable and reliable. If the battery system is installed in an independent equipment cabin (e.g. container), make sure the grounding of the cabin is stable and reliable.

**The resistance of the grounding system must be  $\leq 100\text{m}\Omega$**

#### 3.3.5 Clearance

Minimum distance to heat sources is more than 2 meters. The minimum distance to another battery module(rack) is more than 0.5 meters.

### 3.4 Handling and placement



**Warning:** The battery pile's power terminals are under high voltage DC. It must be installed in a restricted access area;

**Warning:** AXIstorage Li SV1 is a high voltage DC system, operated by qualified and authorized personnel only.

#### 3.4.1 Handling and placement of the battery modules



A single battery module weights 36kg. Without handling tools, it must be handled by at least 2 persons.

### 3.4.2 Handling and placement of the base

The base is light, a single person can handle it.

### 3.4.3 Selection of installation sites

- A. The AXIstorage Li SV1 system's working temperature range is 0°C~50°C; Optimum temperature: 18°C~28°C. Do not place the battery system in direct sunlight. It is suggested to build sunshade equipment. In cold area a heating system is required.
- B. The AXIstorage Li SV1 system must not be immersed in water. The battery base cannot be placed in rain or other water sources. As a suggestion, the base's height shall be >300mm above the ground.
- C. The basement must bear the weight of whole battery system (130~300kg).
- D. The AXIstorage Li SV1 system must be installed on fixed ground.

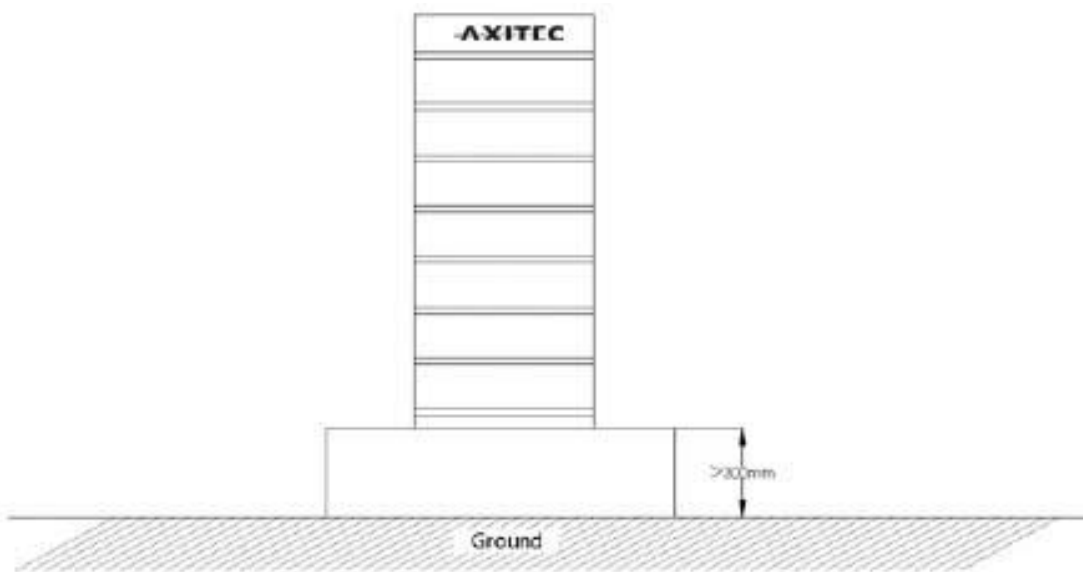

### 3.4.4 Packing list

BMS SV1 Battery Controller		
Item	Description	Set
1	BMS SV1 Battery Controller	1
2	AXIstorage Li SV1 basement (600*380*40, mm)	1
3	EPE foam	3
4	3.5m black external communication cable (RJ45 – M19)	2
5	3.5m DC+ red external power cable (10AWG)	1
6	3.5m DC- black external power cable (10AWG)	1
7	1m yellow-green grounding cable (10AWG)	1

8	M4 screws for fixing the mounting rails	20
9	M8 bolts for fixing the basement	4
10	571.5mm mounting rail For up to 3 battery modules installation	2
11	701.5mm mounting rail for fixing $\leq$ 4 battery modules In combined use with the 571.5mm mounting rail for up to 7 modules installation; see installation picture below;	2
ENERGYPACK LI SV1 Battery Module		
1	Energypack LI SV1 battery module	1
2	EPE foam	2

No additional kits needed for AXIstorage Li SV1 installation.

### 3.4.5 Mounting and installation of the base

The base must be fixed installed on the basement with 4pcs M8×80 foundation bolts.

#### Battery rack basement holes bitmap (unit: mm):

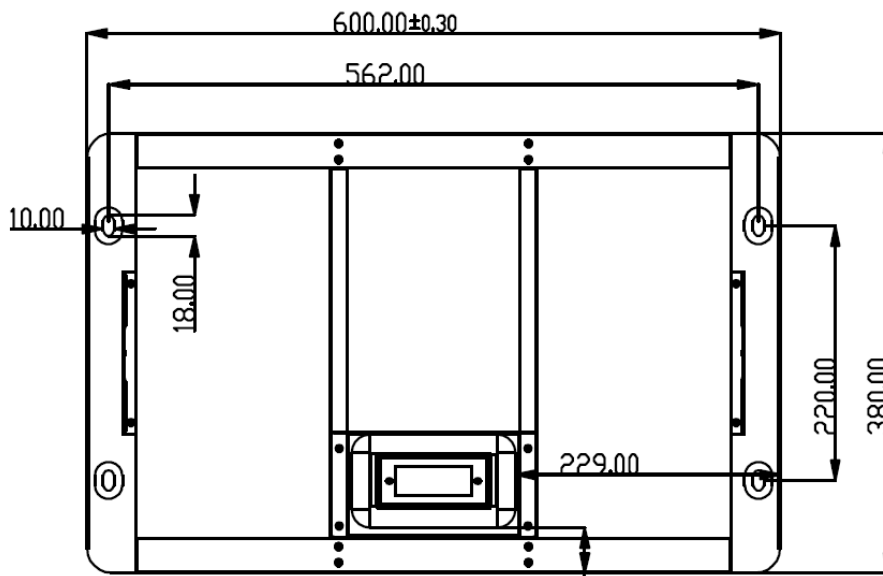

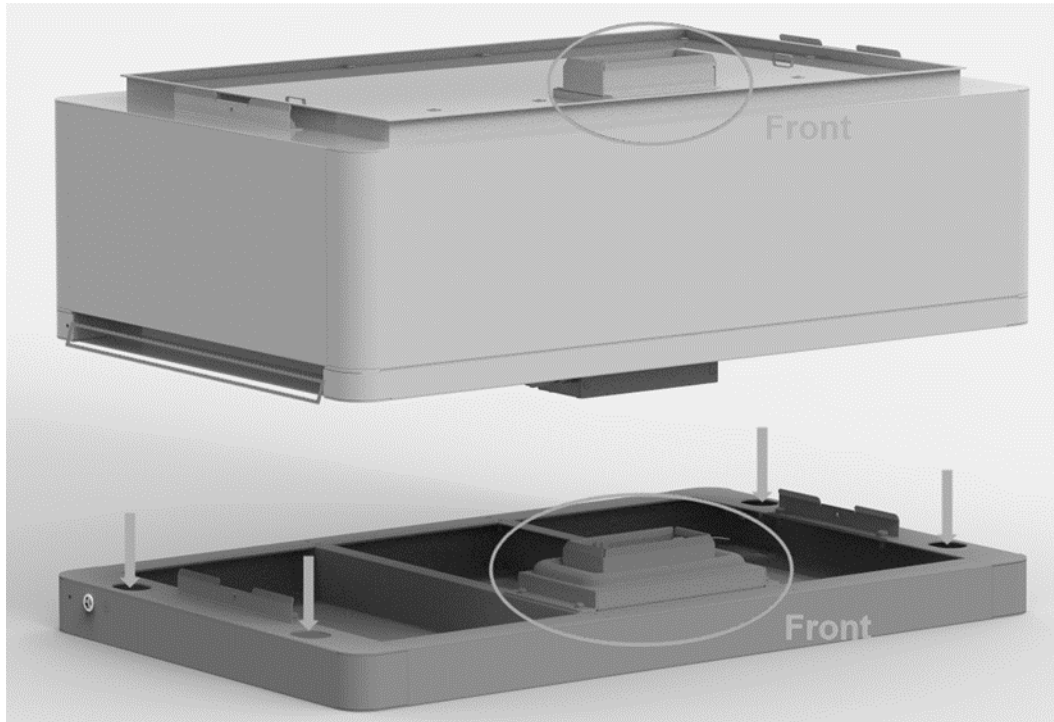

### 3.4.6 Battery Modules and Control Module (BMS) pile up

Handle the modules above the red marked edgings on both sides.

**Caution:** If hands are under this red marked side, hands will get hurt.



**Danger:** when the battery is connected together with the base, the internal sockets still have high voltage DC power from serial connected battery modules (battery module can't be turned off).



### 3.4.7 Installation of the metal mounting rails

In the control module's package there are 2pcs short and 2pcs long metal mounting rails.

Fix these metal mounting rails at both back side corners.

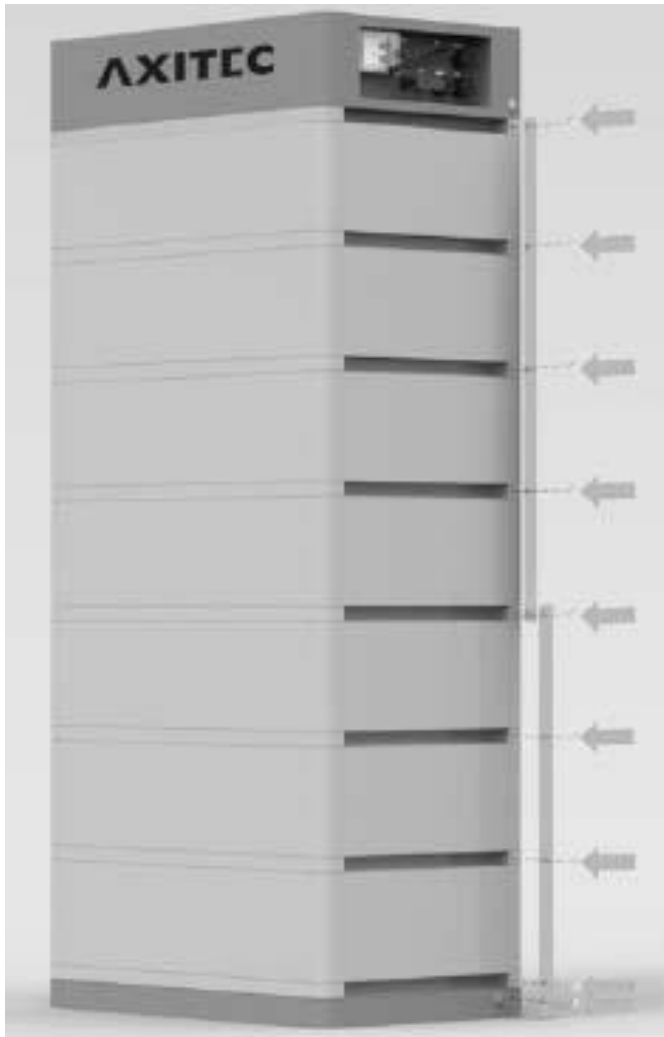

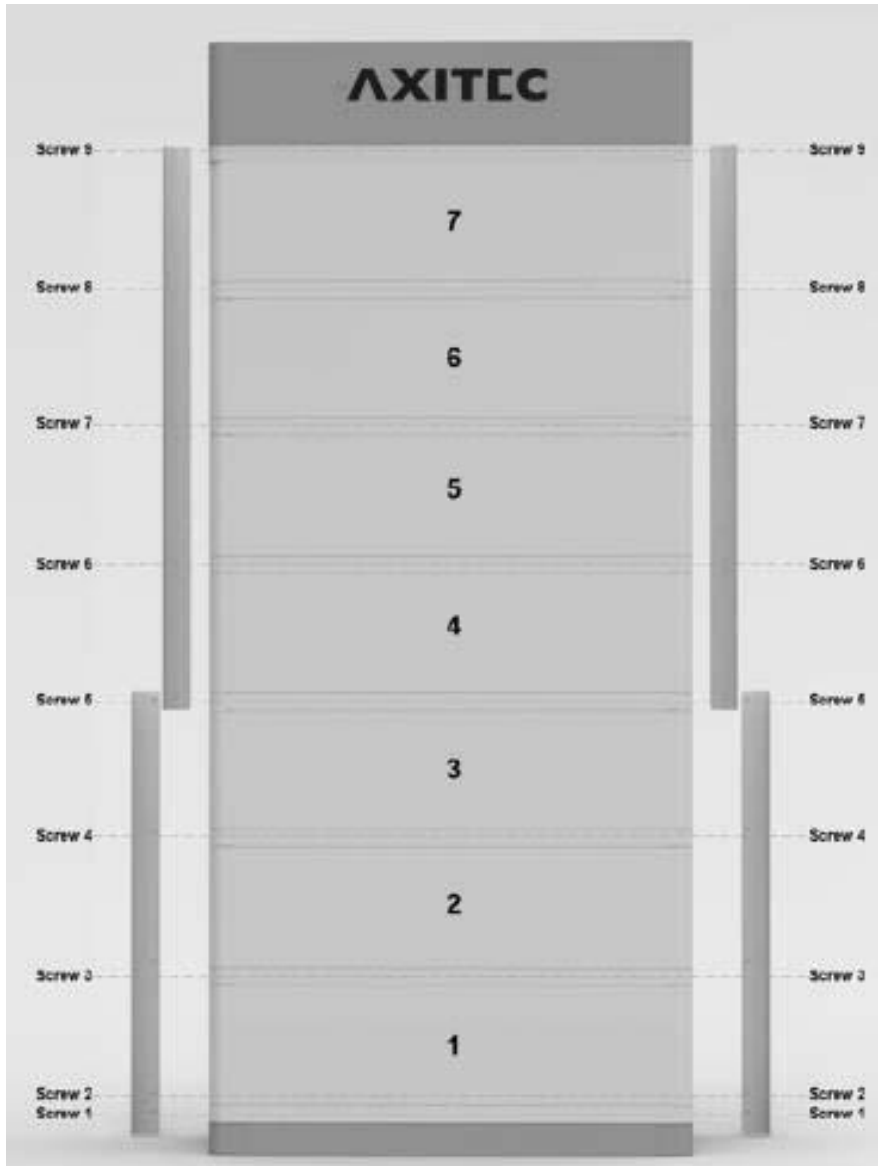

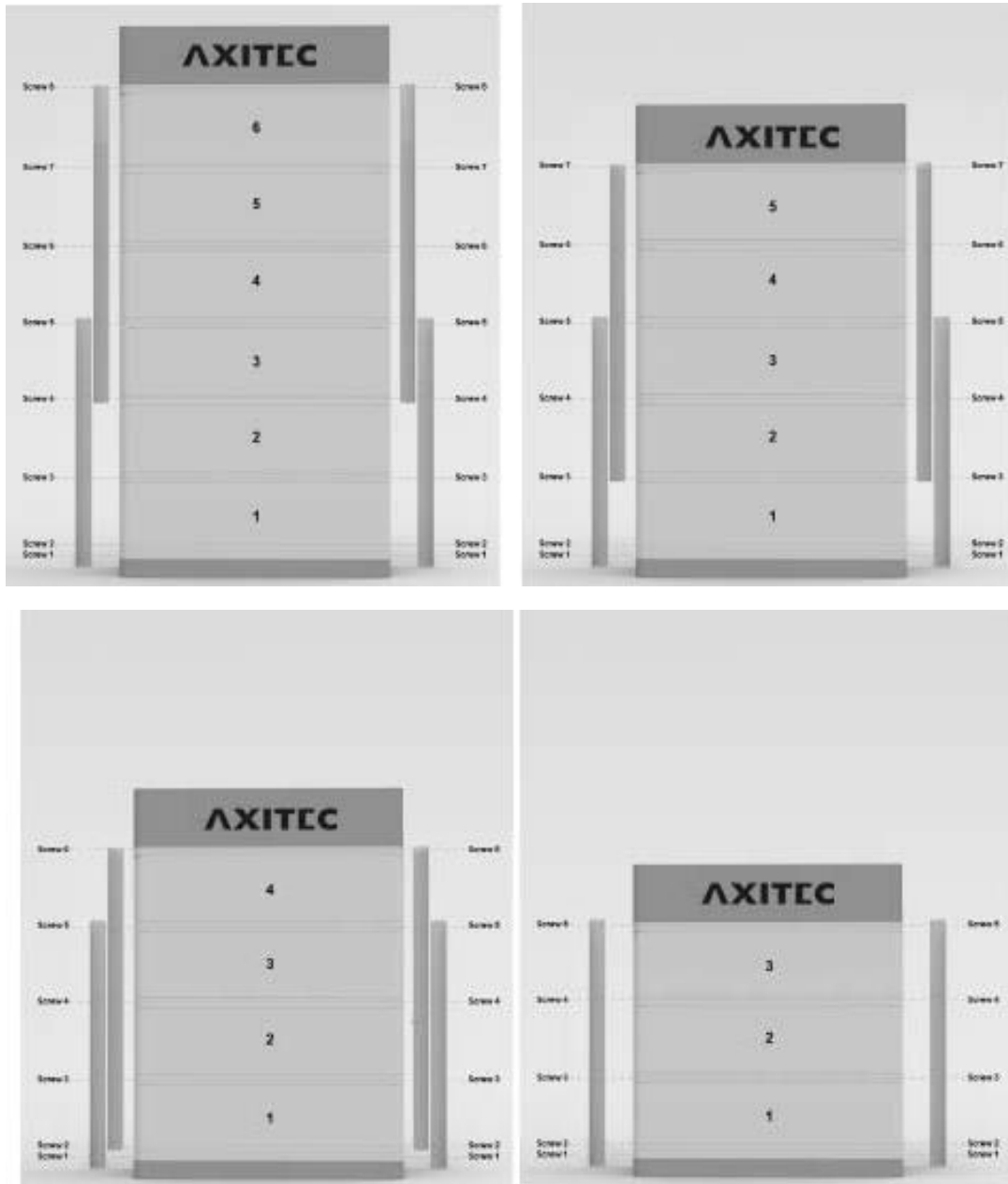

**3.4.8 Locking of the control Module's fix screw on left and right side**



### 3.5 Cables connection

#### Attention:



**Danger:** The battery system is a high voltage DC system. Make sure the grounding is fixed and reliable.

**Danger:** All the plugs and sockets of the power cables must be not reverse connected. Otherwise it will cause personal injury.

**Danger:** No short circuit or reversed connection of the battery system's positive and negative port.

**Caution:** Wrong communication cables connection will cause a battery system failure.



#### 3.5.1 Grounding



The AXIstorage Li SV1 has three grounding points, where the grounding cable can be connected (above the right side of top metal mounting rail screw or beside both sides of the screw in the base). Connect the grounding cable to one of these grounding points.

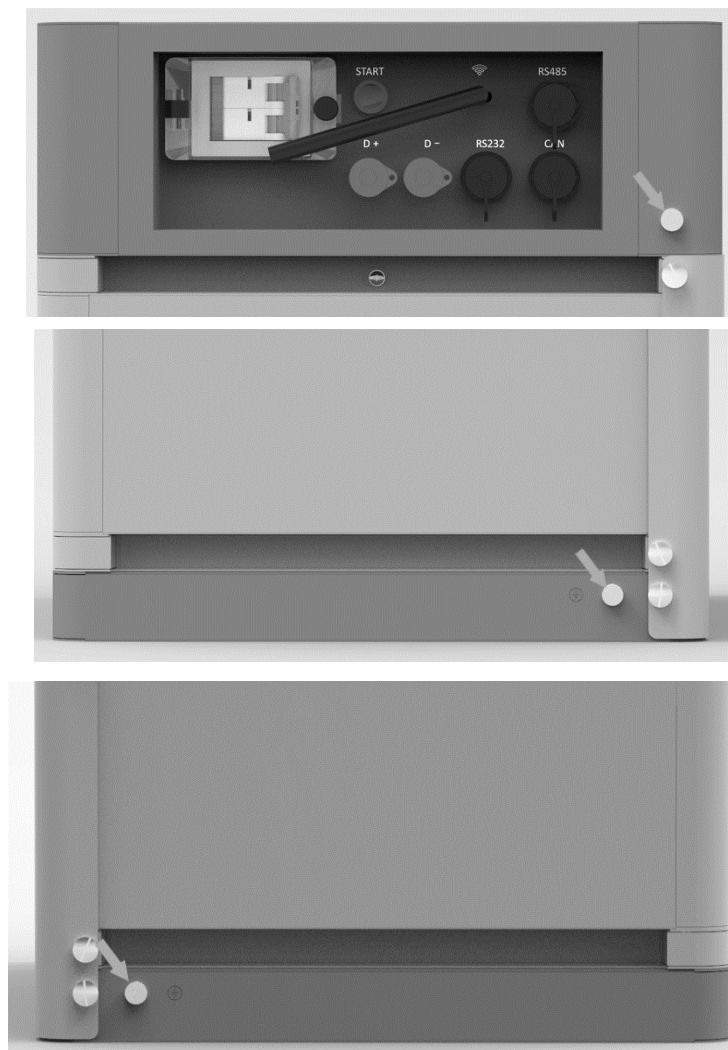

**Grounding cable must  $\geq 10$ AWG. The cable shall be copper with yellow-green color.**



**3.5.2 Cables**



**Note:** For the power cables, water-proof connectors are used. To disconnect, a special tool is required. Do not pull out directly.

**Note:** For communication cable use RJ45 connector and water-proof cover(M19-RJ45) matched with controller connection port.

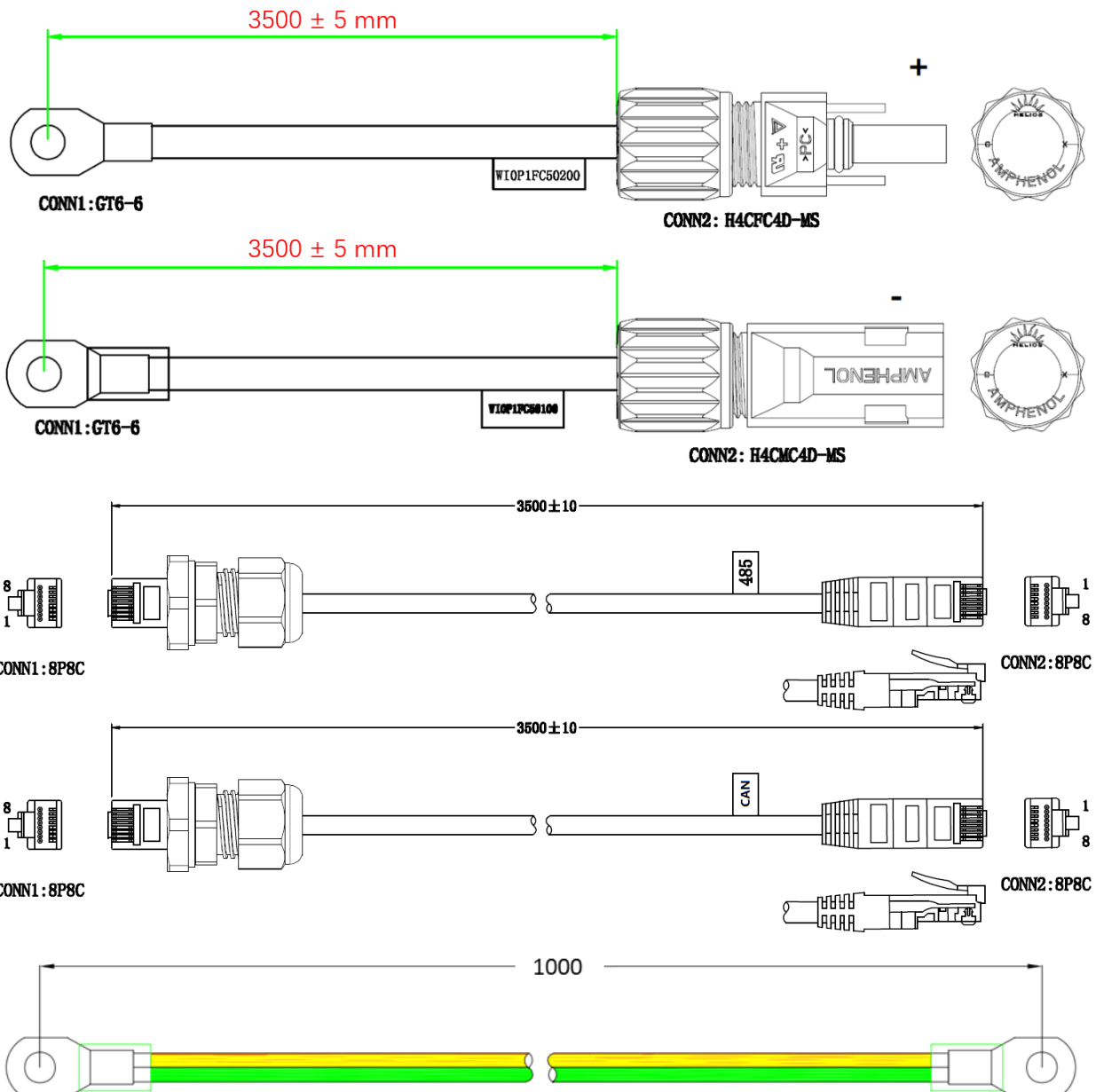

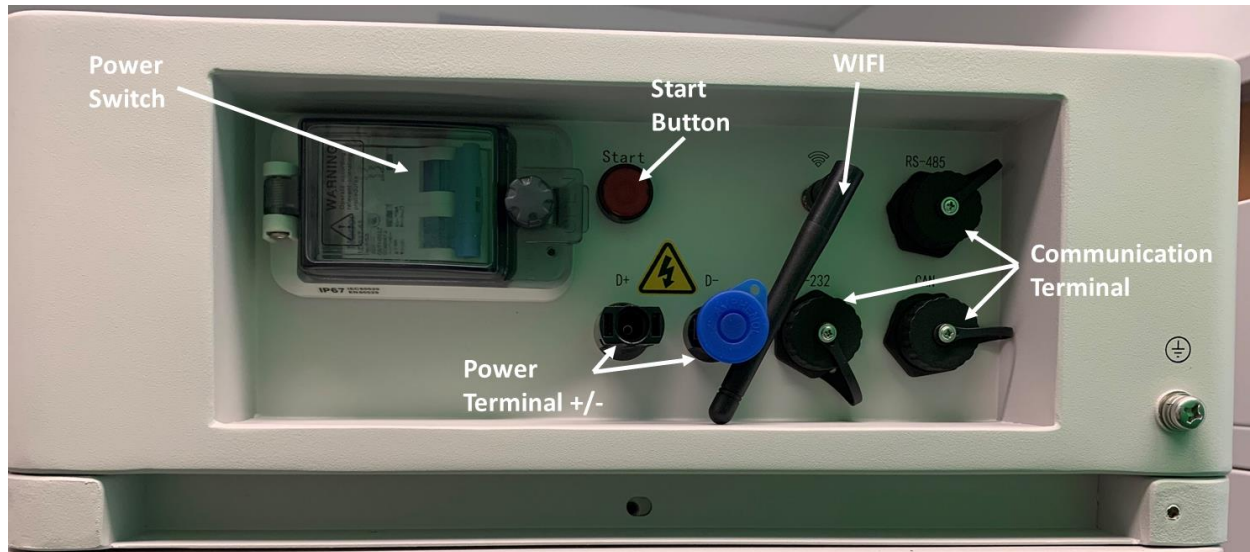

### 3.6 Connection to Inverter

Follow the installation instructions of the inverter for connecting the power cables and the communication cable to the inverter. Check the compatibility of the inverter with the storage unit. Consider the voltage range of the inverter when selecting the number of energy packs. If the storage model must be selected when configuring the inverter, select the Force H1 storage from Pylontech.

The inverters listed in the table below are compatible with the AXIstorage Li SV1.

Brand	Inverter Type	Firmware Version
Sungrow	SH5.0/6.0/8.0/10RT	SAPPHIRE-H_V11_V01_A
GoodWe	EH/ET series	V14
Growatt	SPH10000TL3	V410
Solis	RHI-3P-HVES-5G series	4002E
Ingeteam Power Technology	ISS 1Play 3TL / 6TL	ABH1002AA ABH1003_Q(disp)
	ISS 1Play 3TL M / 6TL M	ABH1007_A ABH1003_Q(disp)
Sermatec	SMT-10K/30K/50K-TL-TH	
Lux Power	Hybrid HB series	
Delios s.r.l.	DLX HV series	V3.00
SolaX Power	X1/X3-Hybrid HV	

### 3.7 Switching on the System



**Warning:** Double check all the power cables and communication cables. Make sure the voltage of the inverter/PCS is same level with the battery system before connection. Check if all the power switches are OFF.

**Steps for switching system on:**

- 1) Check if all cables are connected correctly. Check if the grounding is connected.
- 2) If necessary, turn on the switch at the inverter's battery side or between inverter and battery. If possible, turn on AC or PV power source to wake up the inverter.
- 3) Open the protection cover of the Power switch and turn on power switch.
- 4) Press start button for at least 5 seconds or until the buzzer rings. The battery takes 10-30s for self-checking.

If the inverter is turned on by AC or PV source, then most inverters can setup communication with the BMS automatically. In this case, the BMS will close its relay and the system is ready for work.

If the inverter needs battery power to turn on, then check the LED of the battery, it shall be:

Status: Orange, solid

SOC: blue, solid

In this case, press the Start button for at least 10s, till the Status lights blue and fast flashing, then the battery will black start to support the inverter and after the inverter turned on and set up communication, then BMS is ready for work.



**Caution:** When the breaker is tripped off because of over current or short circuit, wait for 30min to turn it on again, otherwise it may cause damage to the breaker.

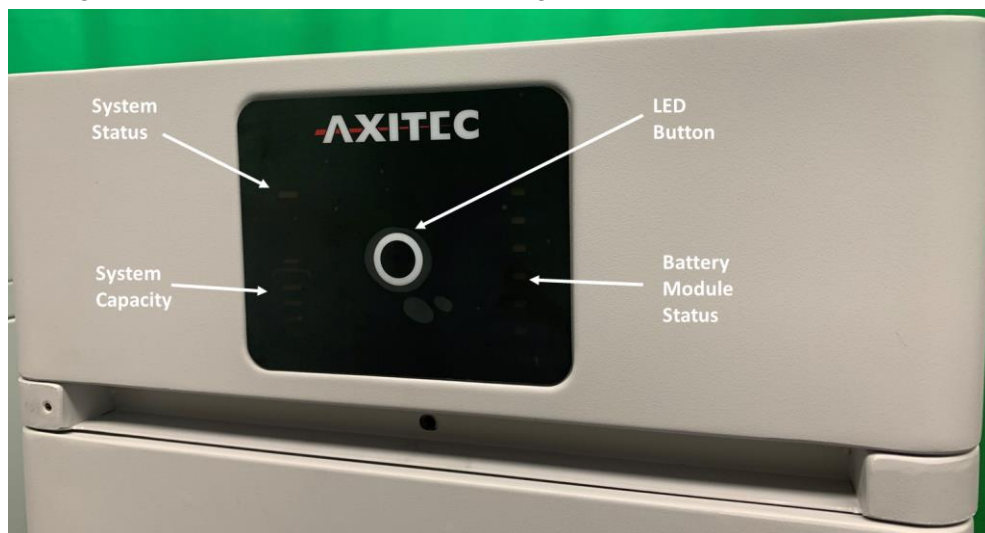

**Warning:** If there is a failure during the self-check, you must first debug the failure and then go to the next step.

If the "STATUS" lamp shows orange from the beginning, it means that there has been some failure in the battery string. The Power relays in the BMS will open, you must debug first.

**Note:** The LED lamp will be off after 20sec without any operation.



**Caution:** During first time power on, the system will require to do full charge progress for SOC calibration purpose.

**Caution:** it is suggested to fully charge the whole Battery Energy Storage System (BESS) first after the installation or after long time storage without charging. Depending on the SOC level, there will be a regularly (3 month) full charge requested during continuous operation as

well. It will be handled automatically by the communication between BESS and the external device.

### 3.8 Switching the System off

When a failure occurs or before service, you must turn the battery storage system off:

- 1) Turn off the inverter or power supply on the DC side.
- 2) Turn off the switch between PCS and battery system.
- 3) Turn off the “Power Switch” of the BMS.

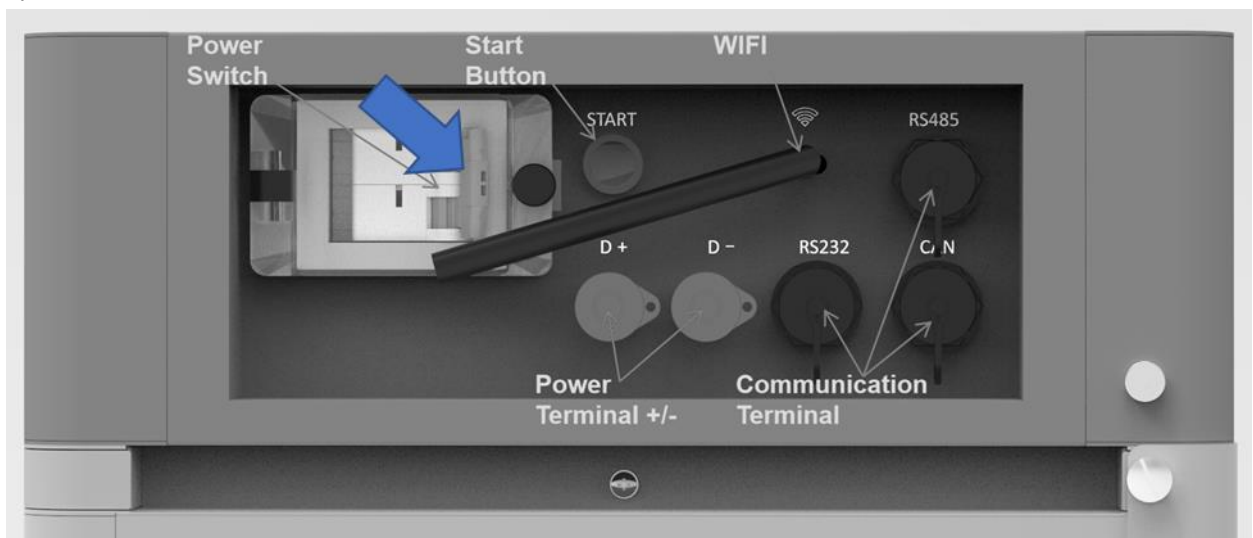

**Caution:** Before replacing the battery module for service, charge/discharge the existing battery modules until its voltage is similar to the voltage of the replacement. Otherwise the system needs long time to do the balancing for this replaced battery module.

### 3.9 Online Monitoring

Online monitoring is possible via the SOLARMAN platform. For easier monitoring of the system status and further information in case of problems, online registration of the storage system is recommended. A WLAN connection must be available for this. Monitoring is possible both with the computer (<https://home.solarmanpv.com/login>) and with the smartphone (SOLARMAN Smart App).



**SOLARMAN Smart**

## 4. System Debug

This system debug is for the Battery Energy Storage System (BESS). The system can't do the debug itself. It must be operated with configured inverter, UPS, PCS and EMS system together.

Debug Step	Content
Preparation of debug.	Turn on the BESS, refer to chapter 3. Before turning on the whole BESS, turning on the load is <b>not allowed!</b> Remark: Except the BESS, if other equipment has its own system turn on steps, follow the operation manual.
Working together with inverter	<ol style="list-style-type: none"> <li>1) Check the communication cable's connection and make sure the cable order on battery and inverter side are matched. All undefined pins are suggested to be empty.</li> <li>2) Check the baud rate of the inverter. The default of battery CAN is 500kbps, MODBUS 485 is 9600bps. If necessary, change the baud rate of RS485.</li> <li>3) Check the terminal resistance: CAN 120 <math>\Omega</math>, 485 120 <math>\Omega</math></li> <li>4) If necessary, check the setting on the inverter or control box, if it has the right parameters and brand of battery. And check if the information of the BESS shown on the inverter are correct.</li> </ol>

## 5. Maintenance

### 5.1 Trouble Shooting:



**Danger:** The AXIstorage Li SV1 is a high voltage DC system, operated by qualified and authorized persons only.

**Danger:** Before checking the failure, check all cable connections and if the BESS can turn on normally or not.

Check the surroundings first

No	Problem	Possible Reason	Solution
1	No power output, no LED on.	Start button pressed too short.	To turn on, push the button for at least 5s To black start, push the button for at least 10s.
		The button battery in the controller is missing or defective. The power supply of the controller is in failure	Change the controller module.
		The battery voltage is too low.	Make sure there are at least 3 battery modules.
		The connector of the base is in failure	The base is not connected or needed to change the base
2	After turned on, status LED is slowly flashing orange. Others are off.	Self-checking failure. DC side has a voltage, but the voltage difference with the battery system is higher than 20V.	Make sure there is no DC voltage or set correct DC voltage before press start button. Then follow turn on process.
		BMS internal failure.	Use debug tool to further analysis or change the controller module.
3	Status LED is fast flashing orange, others are off.	The time interval after the last black start is too short.	Wait more than 5 minutes and try to black start again.
		The battery system is under error condition such as: temperature or current protection or other error, thus it does not response black start.	Make sure there is no other protection factor. Or use the debug tool for further analysis.
4	Buzzer rings permanently	Relay adhesion or failure.	Completely disconnect the battery system from any DC source, then do a restart. If the problem remains, swap the controller.

5	Status LED solid orange. Battery module LED blue solid.	Communication lost with inverter	Check the communication cable PIN and wiring whether it is correct.
		Over current protection.	Check DC side. Wait until BMS releases protection.
		Controller failure.	Use the debug tool for further analysis or change the controller module.
6	Status LED solid orange. Battery module exists and LED is orange solid	Over/ under temperature protection.	Check environment temperature. Wait until the BMS releases.
		Over voltage protection.	Check DC charge voltage setting. Wait until the BMS releases.
		Under voltage protection.	Use black start function and then charge the system.
		Battery module BMS failure	Use debug tool for further analysis or change the battery module.
7	All LEDs light blue but there is no output.	Fuse triggered	Change the controller module
8	Other failure	Cell failure or electrical board failure. Failure needs debug tool for further debugging.	If you can't find out failure point or can't check, please contact distributor or Axitec.

Once a certain failure is detected following the trouble shooting steps, shut down the battery string first before replacement to avoid further over discharge to the system due to self-consumption.

## 5.2 Replacement of main components



**Danger:** The AXIStorage Li SV1 is a high voltage DC system, operated by qualified and authorized persons only.

**Danger:** Before replacing a main component, shut down the maintained battery string's power. Check that the **D+** and **D-** terminals are without power. For the turn off progress refer to chapter 3.6.5.

### 5.2.1 Replacement of Battery Module

5.2.1.1 Fully charge the existing modules (SOC 100%). Make sure the new battery module has a SOC of 100% as well.

5.2.1.2 Turn off the whole battery string's power. Make sure the **D+** and **D-** terminals are without power. For the turn off progress refer to chapter 3.5.4.

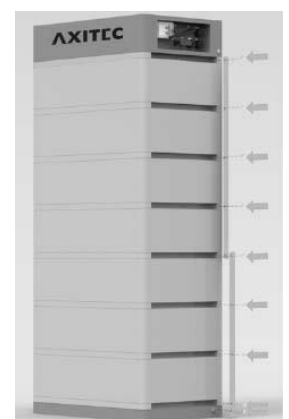

5.2.1.3 Dismantle **D+** and **D-** Power Cable, Communication Cable and Grounding Cable.

5.2.1.4 Dismantle the control Module's fix screws of left and right side. And dismantle the fix metal mounting rails.



5.2.1.5 Move the control module and each battery module one by one.



**Danger:** when battery is connected together with the base, the internal sockets still have high voltage DC power from serial connected battery modules (battery module can't be turned off).



Handle above the red marked edgings on both sides of the battery modules and control module (BMS).

**Caution:** If hands are under this red marked side, hands will get hurt.



**Warning:** A single battery module weights 35kg. Without handling tools at least 2 persons are needed to handle it.

5.2.1.6 Pile up the new battery module. And pile up the battery modules and control module again.

5.2.1.7 Install back the control module's fix screw on the left and right side and Install back the fix metal mounting rails.



5.2.1.8 Install back the grounding Cable, Communication Cable and the **D+** and **D-** Power Cables.

5.2.1.9 Turn on the battery string. Refer to chapter 3.5.3.

## 5.2.2 Replacement of Control Module (BMS)

5.2.2.1 Turn off the whole battery string's power. Make sure the **D+** and **D-** terminals are without power. For the turn off progress refer to chapter 3.5.4.

5.2.2.2 Dismantle **D+** and **D-** Power Cables, Communication Cable and Grounding Cable.

5.2.2.3 Dismantle the control Module's fix screw on the left and right side and dismantle the fix metal mounting rails.

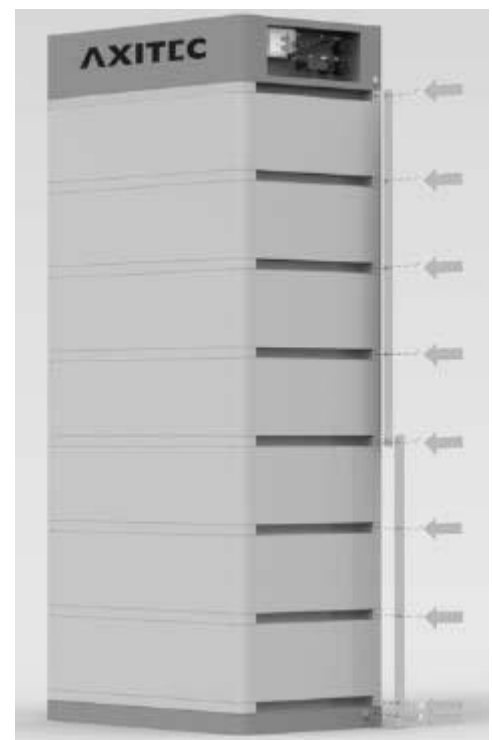

5.2.2.4 Remove the control module.



**Danger:** when battery is connected together with the base, the internal sockets still have high voltage DC power from serial connected battery modules (battery module can't be turned off).



5.2.2.5 Pile up the new control module.

5.2.2.6 Install back the control Module's fix screw on left and right side. And Install back the fix metal mounting rails.

5.2.2.7 Install back Grounding Cable, Communication Cable and the **D+** and **D-** Power Cables.

5.2.2.8 Turn on the battery string. Refer to chapter 3.5.4.



### 5.3 Battery Maintenance

**Danger:** The maintenance of the battery must be done by qualified and authorized personnel only.

**Danger:** For some maintenance, the system must be turned off at first (Cables Inspection and Output Relais Inspection).

#### 5.3.1 Voltage Inspection:

**[Periodical Maintenance]** Check the voltage of the battery system through the monitoring system. Check the system whether there are abnormal voltages or not. For example: A single cell's voltage is abnormal high or low.

#### 5.3.2 SOC Inspection:

**[Periodical Maintenance]** Check the SOC of the battery system through the monitoring system. Check the battery string whether exist abnormal SOC or not.

#### 5.3.3 Cables Inspection:

**[Periodical Maintenance]** Visually inspect all the cables of the battery system. Check if the cables are broken, aging or getting loose.

#### 5.3.4 Balancing:

**[Periodical Maintenance]** The battery strings will become unbalanced if the system has not been fully charged for a long time. Solution: every 3 months, the system should do the balancing maintenance (charge to full). Normally this will be done automatically by the communication between system and external device.

#### 5.3.5 Output Relay Inspection:

**[Periodical Maintenance]** Under low load conditions (low current), control the output relay OFF and ON to hear if the relay has a click voice. That means this relay can work normally.

#### 5.3.6 History Inspection:

**[Periodical Maintenance]** Analyse the history record to check whether there was an accident (alarm and protection) and analyse its reason.

#### 5.3.7 Shutdown and Maintenance:

##### **[Periodical Maintenance]**

Some system function must be maintained during the EMS restart, it is recommended to maintenance the system every 6 months.

#### 5.3.8 Recycle

##### **NOTE**

Damaged batteries may leak electrolyte or produce flammable gas.

In case that a damaged battery needs recycling, it shall follow the local recycling regulation (ie. Regulation (EC) N° 1013/2006 among European Union) to process, and using the best available techniques to achieve a relevant recycling efficiency.

## 6. Remarks

### Storage recommendation

For long-term storage (more than 3 months), the battery cells should be stored in a temperature range of 5~45°C, relative humidity <65% and in no corrosive gas environment.

The battery modules should be shelved in a temperature range of 5~45°C, in a dry, clean and well ventilated environment. Before storing, the batteries should be charged to 50~55% SoC;

It is recommended to activate (discharge and charge) the battery every 3 months, and the longest discharge and charge interval shall not exceed 6 months.



Caution: If the above instructions for long term storing the battery are not followed, the cycle life will have a relative heavy reduction.

### Capacity expansion

A new battery module can be added onto an existing system at any time. Please make sure the existing system is fully charged before adding a new module. In a serial connected system, the new module has a higher SOH, but it will follow the system's worst module to perform.

## 7. Shipment

Battery modules will be pre-charged to 100%SOC or according to customer requirement before shipment. The remaining capacity of battery cell after shipment and before charge, is determined by the storage time and condition.

1. The battery modules meet the UN38.3 certificate standard.
2. In particular, special rules for the carriage of goods on the road and the current dangerous goods law, specifically ADR (European Convention on the International Carriage of Dangerous Goods by Road), as amended, must be observed.

Any further questions, please contact Axitec: [energy@axitecsolar.com](mailto:energy@axitecsolar.com)

## Annex 1: Installation and System Turn ON Progress List

Tick after completion	No.	Item	Remark
<input type="checkbox"/>	1	The environment is meeting all technical requirements. 3.3.1 Cleaning 3.3.2 Temperature 3.3.3 Fire-extinguisher System 3.3.4 Grounding System 3.3.5 Clearance	Refer to chapter 3.3
<input type="checkbox"/>	2	Selection of installation sites.	Refer to chapter 3.4.3.
<input type="checkbox"/>	3	Battery base is installed following the technical requirements.	Refer to chapter 3.4.4.
<input type="checkbox"/>	4	Battery modules installation.	Refer to chapter 3.4.5.
<input type="checkbox"/>	5	Battery system is fixed.	Refer to chapter 3.4.6.
<input type="checkbox"/>	6	Control Module (BMS) and Battery Modules are installed well.	Refer to chapter 3.4.7.
<input type="checkbox"/>	7	Connect <b>D+ and D-</b> between BMS and inverter/PCS or confluence cabinet.	Refer to chapter 3.5.2.
<input type="checkbox"/>	8	Connect the grounding cable.	Refer to chapter 3.5.1.
<input type="checkbox"/>	9	Double check if every <b>power cable, communication cable, grounding cable</b> is installed well.	Refer to chapter 3.5.2 and 3.5.1.
<input type="checkbox"/>	10	Switch the external power or inverter/PCS on, ensure that all the power equipment can work normally.	Refer to chapter 3.6.4.
<input type="checkbox"/>	11	The first installation should do full charging progress automatically. If the status LED of BMS turns to blue, it means this battery string is operating.	

**Annex 2: System Turn OFF Progress List**

Tick after completion	No.	Item	Remark
<input type="checkbox"/>	1	Soft-off the inverter through inverter's control panel.	Refer to chapter 3.5.4.
<input type="checkbox"/>	2	Turn off the switch between inverter and this battery string (AXIstorage Li SV1), or turn off the power switch of inverter, to make sure no current flows through this battery string.	Refer to chapter 3.5.4.
<input type="checkbox"/>	3	Turn off the "Power Switch" of the BMS.	Refer to chapter 3.5.4.