

The background of the cover page is a photograph of a solar farm. In the foreground, several rows of dark blue solar panels are mounted on metal frames, extending into the distance. The ground is green grass. The sky is bright blue with some light clouds and a sun flare effect in the upper left corner. A large, semi-transparent red parallelogram is overlaid on the right side of the image, containing the title text.

# Installation Manual for LONGi Solar PV Modules

| Applicable Module Type |                 |                 | Certification Status | Module Structure |
|------------------------|-----------------|-----------------|----------------------|------------------|
| Monofacial<br>Module   | LR6-60-***M     | LR6-72-***M     | IEC、UL               | single glass     |
|                        | LR6-60BK-***M   | LR6-72BK-***M   | IEC、UL               | single glass     |
|                        | LR6-60HV-***M   | LR6-72HV-***M   | IEC、UL               | single glass     |
|                        | LR6-60PB-***M   | LR6-72PB-***M   | IEC、UL               | single glass     |
|                        | LR6-60PE-***M   | LR6-72PE-***M   | IEC、UL               | single glass     |
|                        | LR6-60PH-***M   | LR6-72PH-***M   | IEC、UL               | single glass     |
|                        | LR6-60MP-***M   | LR6-72MP-***M   | IEC                  | single glass     |
|                        | LR6-60MPH-***M  | LR6-72MPH-***M  | IEC                  | single glass     |
|                        | LR6-60HPH-***M  | LR6-72HPH-***M  | IEC、UL               | single glass     |
|                        | LR6-60HPH-***MC | LR6-72HPH-***MC | IEC、UL               | single glass     |
|                        | LR6-60HPB-***M  | /               | IEC、UL               | single glass     |
|                        | LR6-60OPH-***M  | LR6-72OPH-***M  | IEC                  | single glass     |
|                        | LR6-60DG-***M   | LR6-72DG-***M   | IEC、UL               | double glass     |
|                        | LR6-60PD-***M   | LR6-72PD-***M   | IEC、UL               | double glass     |
|                        | LR6-60HPD-***M  | LR6-72HPD-***M  | IEC、UL               | double glass     |
|                        | LR6-60HIH-***M  | LR6-72HIH-***M  | IEC、UL               | single glass     |
|                        | LR6-60HIB-***M  | /               | IEC、UL               | single glass     |
|                        | LR4-60HPH-***M  | LR4-72HPH-***M  | IEC、UL               | single glass     |
|                        | LR4-60HPB-***M  | /               | IEC、UL               | single glass     |
|                        | LR4-60HIH-***M  | LR4-72HIH-***M  | IEC、UL               | single glass     |
|                        | LR4-60HIB-***M  | /               | IEC、UL               | single glass     |
|                        | LR4-66HPH-***M  | /               | IEC、UL               | single glass     |
|                        | LR4-66HP-***M   | /               | IEC、UL               | single glass     |
|                        | LR4-66HIH-***M  | /               | IEC、UL               | single glass     |
|                        | LR5-66HPH-***M  | LR5-72HPH-***M  | IEC、UL               | single glass     |
|                        | LR5-66HIH-***M  | LR5-72HIH-***M  | IEC、UL               | single glass     |
| Bifacial<br>Module     | LR6-60BP-***M   | LR6-72BP-***M   | IEC、UL               | double glass     |
|                        | LR6-60HBD-***M  | LR6-72HBD-***M  | IEC、UL               | double glass     |
|                        | LR6-60HBD-***MC | LR6-72HBD-***MC | IEC、UL               | double glass     |
|                        | /               | LR6-78HBD-***M  | IEC、UL               | double glass     |
|                        | LR6-60OPD-***M  | LR6-72OPD-***M  | IEC                  | double glass     |
|                        | LR6-60HIBD-***M | LR6-72HIBD-***M | IEC、UL               | double glass     |
|                        | LR4-60HBD-***M  | LR4-72HBD-***M  | IEC、UL               | double glass     |
|                        | LR4-60HIBD-***M | LR4-72HIBD-***M | IEC、UL               | double glass     |
|                        | LR5-66HBD-***M  | LR5-72HBD-***M  | IEC、UL               | double glass     |
|                        | LR5-66HIBD-***M | LR5-72HIBD-***M | IEC、UL               | double glass     |



## Safety Note

- This manual elaborates on installation and safety use information for PV power generating modules (hereinafter referred to as module) of LONGi Solar Technology Co., Ltd. (hereinafter referred to as LONGi). Please abide by all safety precautions in this guide and local regulations.
- Installation of modules requires professional skills and knowledge and is to be carried out by qualified personnel. Please read this manual carefully before installing and using this module. Installation personnel shall get familiar with mechanical and electrical requirements of this system. Please keep this manual properly as reference for future maintenance or upkeep or for sales and treatment of modules.
- If you have any doubts, please contact LONGi global quality and customer service department for further interpretation.

# Contents

|    |   |
|----|---|
| 3  | 1 / Introduction  |
| 3  | 2 / Laws and Regulation                                     |
| 4  | 3 / General Information                                     |
| 4  | 3.1 Modules Identification                                  |
| 6  | 3.2 Junction box style and wiring method                    |
| 8  | 3.3 Regular Safety  |
| 9  | 3.4 Electrical Performance Safety                           |
| 9  | 3.5 Operation Safety  |
| 10 | 3.6 Fire Safety   |
| 11 | 4 / Installation Conditions                                 |
| 11 | 4.1 Installation Site and Working Environment               |
| 12 | 4.2 Selection of Tilt Angles                                |
| 13 | 5 / Mechanical Installation                                 |
| 13 | 5.1 Regular Requirements                                    |
| 13 | 5.2 Monofacial assembly mechanical installation             |
| 14 | 5.2.1 Bolts Mounting  |
| 14 | 5.2.2 Clamp Mounting  |
| 15 | 5.2.3 Installation and Mechanical Load of Monofacial Module |
| 17 | 5.3 Bifacial module Mechanical Installation                 |
| 17 | 5.3.1 Bolts Mounting  |
| 18 | 5.3.2 Clamps Installation                                   |
| 19 | 5.3.3 Installation and Mechanical Load of Bifacial Module   |
| 21 | 6 / Electrical installation                                 |
| 21 | 6.1 Electrical Performance                                  |
| 22 | 6.2 Cables and Wiring                                       |
| 23 | 6.3 Connector   |
| 23 | 6.4 Bypass diode  |
| 23 | 6.5 PID Protection and Inverter Compatibility               |
| 24 | 7 / Grounding   |
| 25 | 8 / Operation and maintenance                               |
| 25 | 8.1 Cleaning  |
| 26 | 8.2 Module Appearance Inspection                            |
| 26 | 8.3 Inspection of Connectors and Cables                     |

## 1 Introduction

Electrical and mechanical installation information will be introduced in this installation manual, so please read and understand the information before installing LONGi modules. In addition, this manual also contains some safety information that you shall be familiar with. All contents in this manual are intellectual properties of LONGi which originates from long term of technical exploration and experience accumulation of LONGi.

This installation manual does not entail any explicit or implicit quality warranty and does not stipulate on compensation schemes for losses, module damages or other costs caused by or related to module installation, operation, utilization and maintenance process. LONGi will not take any responsibility if patent rights or the third party rights are infringed by use of modules. LONGi reserves the rights for modifying product manual or installation manual without noticing in advance. It is recommended to visit our website regularly at [www.longi-solar.com](http://www.longi-solar.com) for the latest version of this installation manual.

If customers fail to install modules as per requirements set forth in this manual, the limited warranty provided for customers will be invalid. In addition, suggestions in this manual are to improve safety of module installation, which are tested and proved by practices. Please provide this manual to PV system users for reference and advise on PPE(Personal Protective Equipment), operation and maintenance requirements and other suggestions.

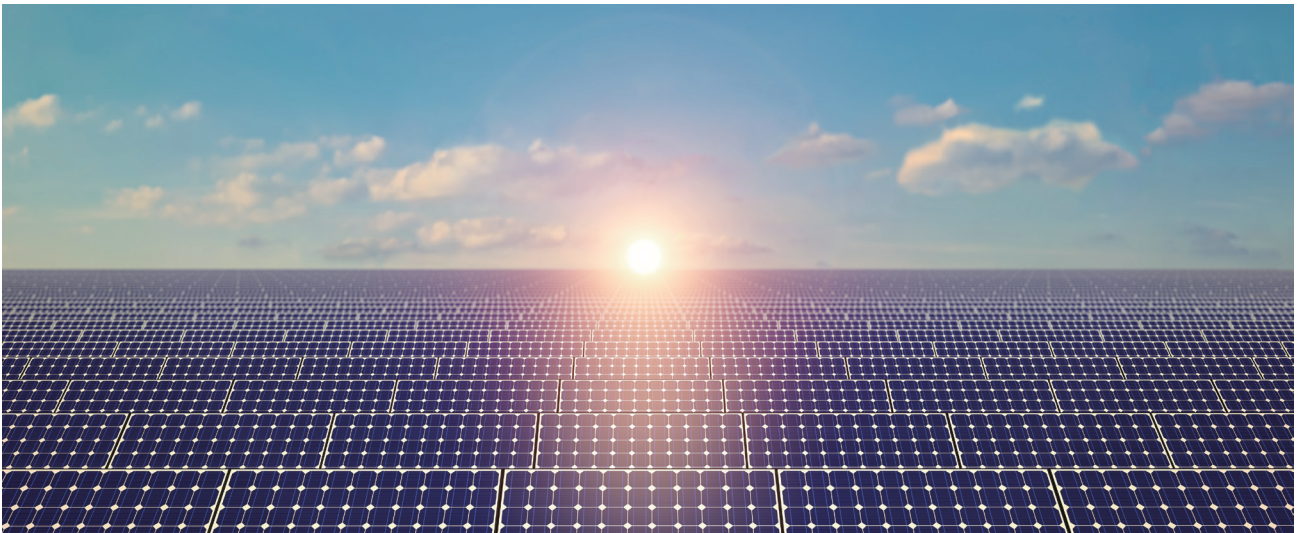

## 2 Laws and Regulation

**The mechanical and electrical installation of photovoltaic modules shall be in accordance with applicable regulations, including electrical law, construction law and electrical connection requirements. These regulations vary from sites to sites, for example, building roof installation, vehicle applications, etc. Requirements may also vary depending on the installed system voltage, DC or AC. Please contact local authorities for specific terms.**

## 3 General Information

### 3.1 Modules identification

3 labels on the modules contain information below:

1. Nameplate: product type, rated power, rated current, rated voltage, open circuit voltage, short circuit current under testing conditions, certification indicator, maximum system voltage, etc.
2. Current classification label: Rated working current.(H indicates High, M indicates Medium, L indicates Low)
3. Serial Number label: A unique serial number which is laminated inside the module permanently which can be found in the front of the module. There is another same serial number beside the module nameplate.

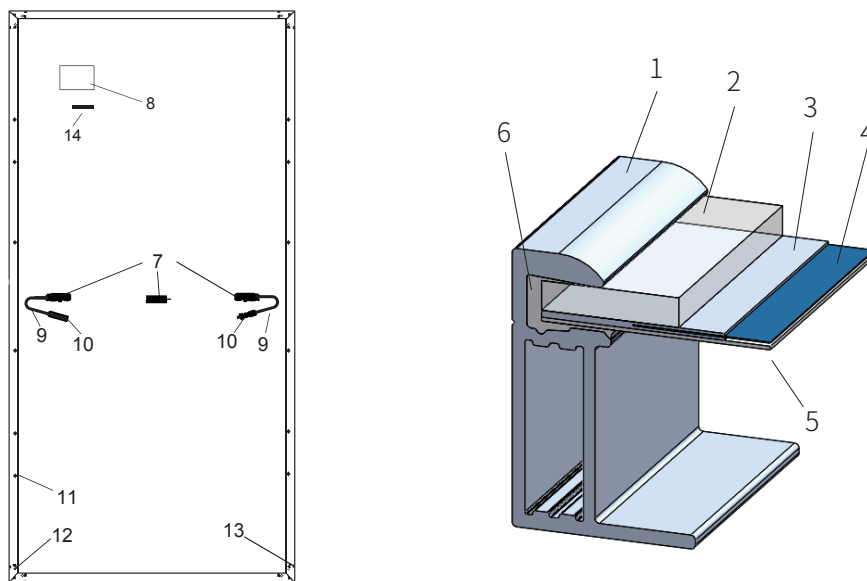

|    |            |    |            |    |               |    |                |
|----|------------|----|------------|----|---------------|----|----------------|
| 1  | Frame      | 2  | Glass      | 3  | EVA           | 4  | Solar Cell     |
| 5  | Backsheet  | 6  | Silica Gel | 7  | Junction Box  | 8  | Name Plate     |
| 9  | Cable      | 10 | Connector  | 11 | Mounting Hole | 12 | Grounding Hole |
| 13 | Drain Hole | 14 | Bar Code   |    |               |    |                |

Figure 1 Regular modules Mechanical drawing

(Please refer to section 3.2 for the location of the junction box. The specific version is subject to the corresponding specification.)



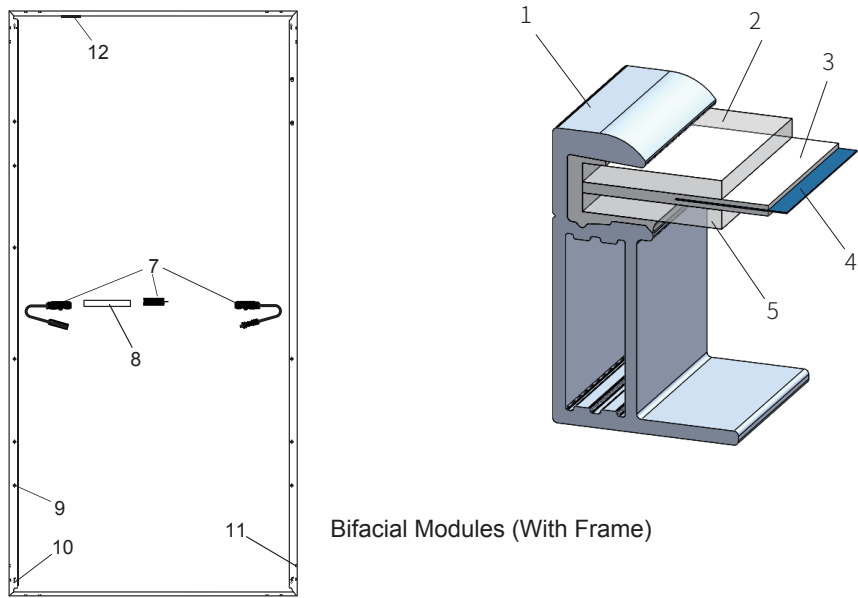

Bifacial Modules (With Frame)

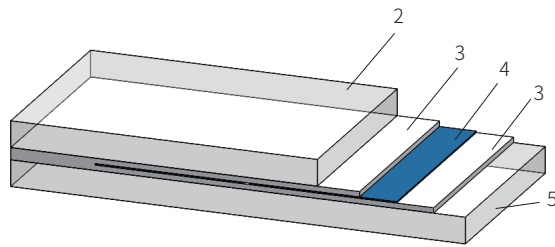

Bifacial Modules (Frameless)

|   |                |    |                 |    |              |    |            |
|---|----------------|----|-----------------|----|--------------|----|------------|
| 1 | Frame          | 2  | Front Glass     | 3  | EVA/POE      | 4  | Solar Cell |
| 5 | Back Glass     | 6  | Sealant         | 7  | Junction Box | 8  | Name Plate |
| 9 | Mounting Holes | 10 | Grounding Holes | 11 | Drain Holes  | 12 | Bar Code   |

Figure 2 Regular Modules Mechanical Drawing

(Please refer to section 3.2 for the location of the junction box. The specific version is subject to the corresponding specification.)

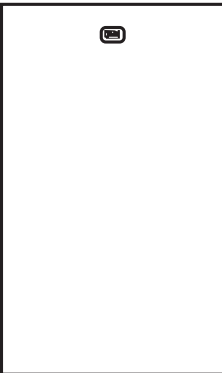
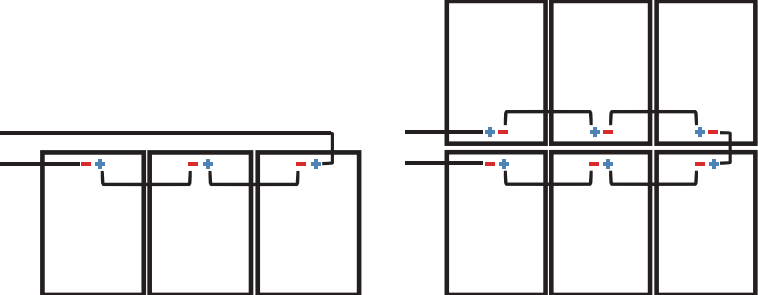
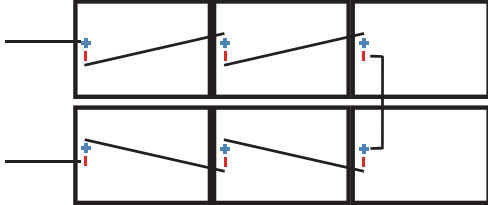
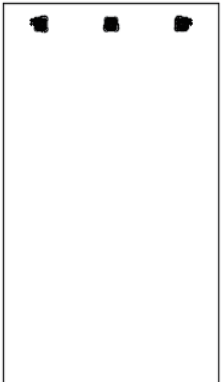
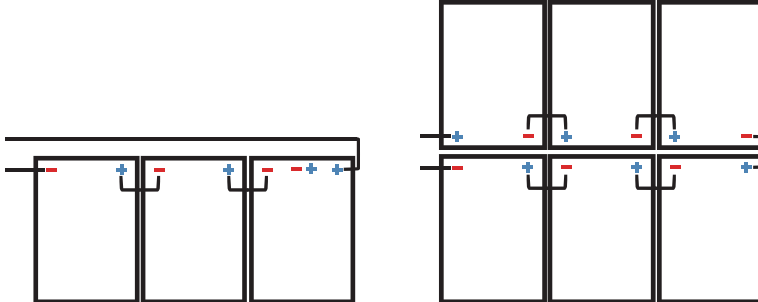
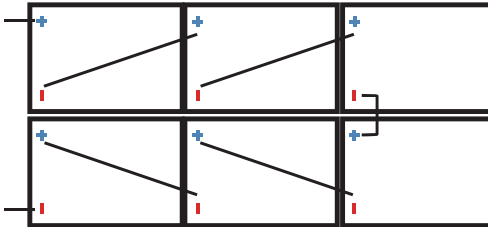

### 3.2 Junction box style and wiring method

| Junction Box Location Icon  | Recommended Wiring Method  |
|---|--|
|    | <p data-bbox="635 379 1396 437">Vertical Installation: Standard Cable Length<br/>(Note: One end of the single row needs to be extended.)</p>   |
|   | <p data-bbox="635 858 1125 886">Horizontal Installation: Standard Cable Length</p>    |
|  | <p data-bbox="635 1187 1396 1246">Vertical Installation: Standard Cable Length<br/>(Note: One end of the single row needs to be extended.)</p>   |
|   | <p data-bbox="635 1651 1444 1709">Horizontal Installation: 60 type PV module cable length <math>\geq 1.2\text{m}</math>, 72 type PV module cable length <math>\geq 1.4\text{m}</math></p>  |

## Junction Box Location Icon

## Recommended Wiring Method

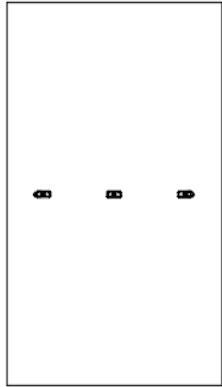

Vertical Installation: Standard Cable length:  
 (Note: An extension cord is required at the rotor head of the double row assembly and at the end of the single row.)

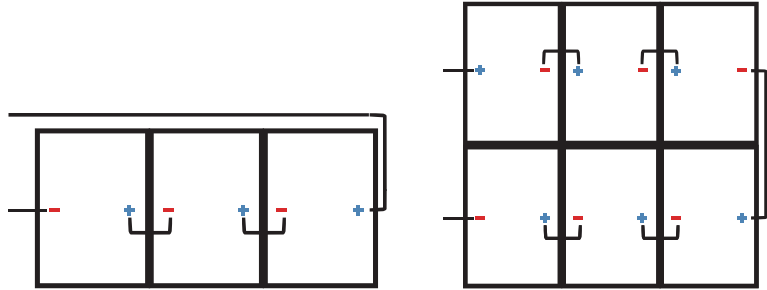

Horizontal Installation:  
 60 type PV module cable length  $\geq 1.2\text{m}$ , 72 type PV module cable length  $\geq 1.4\text{m}$ , 78 type PV module cable length  $\geq 1.5\text{m}$

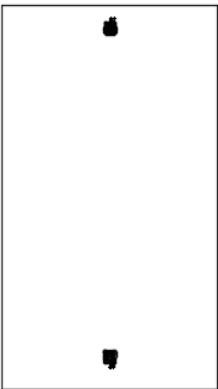
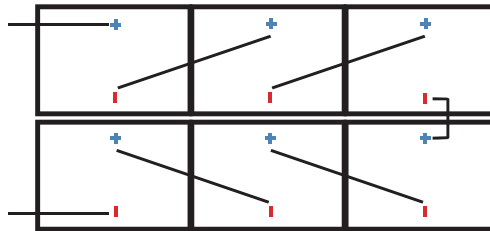

Vertical Installation:  
 Method 1: Standard cable length

Method 2: Single component cable length  $\geq 1.2\text{m}$

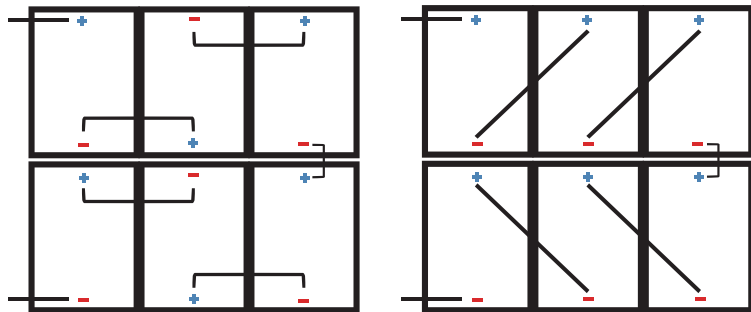

Horizontal Installation: Standard cable length

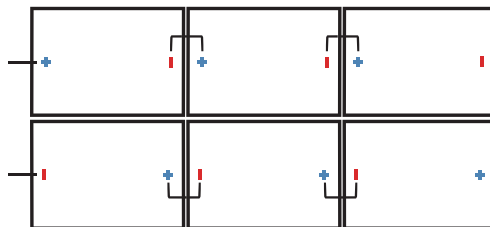



| Junction Box Location Icon  | Recommended Wiring Method   |
|---|---|
|  | <p>Vertical installation:</p> <p>Method 1: Standard cable length</p>  <p>Method 2: Single component cable length <math>\geq 1.2\text{m}</math></p>  <hr/> <p>Horizontal Installation: Standard cable length</p>  |

Figure 3 Junction Box Style and Wiring Method



The application level of LONGi Solar module is Class II, which can be used in systems operating at  $> 50\text{ V DC}$  or  $>240\text{ W}$ , where general contact access is anticipated;

When the modules are for rooftop application, it is necessary to take the overall fire rating of the finished structure as well as operation and maintenance into account. The roofing PV system shall be installed after being evaluated by construction experts or engineers and with official analysis results for the entire structure. It shall be proved capable of supporting extra system bracket pressure, including PV module weight.

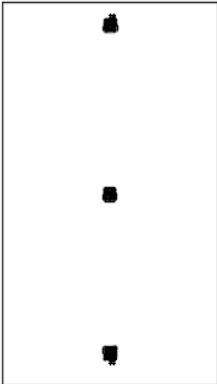
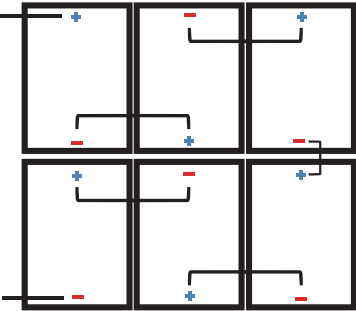
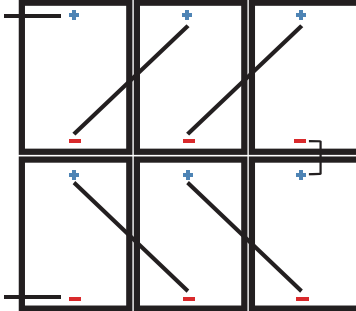
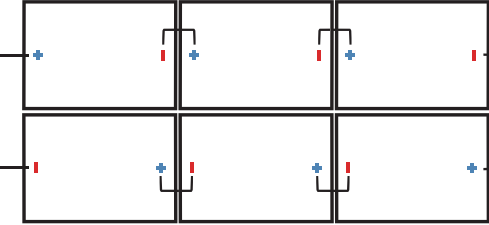
For your safety, please do not work on the roof without PPE(Personal Protective Equipment) which include but not limited

to fall protection, ladder or stair and personal protective measures.

For your safety, please do not install or handle modules in unsafe conditions including but not limited to strong wind or gust, damp or sandy roofs.



PV modules can produce DC current under illumination, any contact of the exposed metal of the modules connection wires may result in electrical shock or burn. Any contact of 30V or larger DC Voltage can be fatal.

In case of no connected load or external circuits, modules can still produce voltage. Please use insulation tools and wear rubber gloves when operating modules in the sunlight.

No switch is on the PV modules. Operating of PV modules can only be stopped when they are kept from sunlight or covered by hard board or UV-proof materials or when the angle of the modules facing sun are placed on smooth and flat surfaces.

To avoid electric arc or electric shock hazards, please do not break down electric connection in loaded conditions. Incorrect connections will also lead to electric arc or shock. Keep connectors dry and clean and make sure that they are in good operating condition. Do not insert other metals into the connectors or carry out electric connection by whatever means. Snow, water or other reflective medium in surrounding environments that intensify light re-reflection will increase output current and power. And module voltage and power will increase under low temperature condition.

If module glass or other sealing materials are damaged, please wear PPE(personal protective equipment) and then isolate modules from the circuit.

Do not operate when modules are wet unless you wear PPE(personal protective equipment). Please follow the cleaning requirements in this manual when cleaning modules.

Do not contact connectors with the following chemicals: Gasoline, White Flower oil , woodlock oil, Mold temperature oil, Engine oil (such as KV46) , Grease (such as Molykote EM-50L) , Lubricating oil, Rust-proof oil, Stamping oil, Diesel, Cooking oil, Acetone, alcohol, essential balm, Bone-setting liquid, Banana oil, release agent (such as Pelicoat S-6) , adhesive and potting materials capable of generating oxime gas (such as KE200、CX-200、chemlok) , TBP, cleaning agent etc.





- Open modules outer Package when installation.
- Do not damage the package and do not drop packaged modules on the ground.
- Do not exceed the indicated maximum layer limit on the packaging carton when piling modules up.
- Put packaging carton in the ventilated, water-proof and dry places before unpacking modules.
- Follow unpacking instructions when Opening packaging carton.
- Carrying modules with the junction box or wires are strictly forbidden.
- Do not stand or walk on modules.
- To avoid glass to be damaged, heavy objects are not allowed on modules.
- Be careful when placing modules at corners in particular.
- Do not try to dismantle the module or remove nameplate or parts of modules.
- Do not paint or apply any other adhesive on modules.
- Do not damage or scratch backsheet of modules.
- Do not drill holes on the frame of module, which may reduce frame loading capacity and lead to frame corrosion and invalidation of the limited warranty provided for customers
- Do not scratch anodic coating of aluminum alloy frame except for grounding connection. Scratch may lead to frame corrosion and reduce frame loading capacity and long-term reliability.
- Do not repair problematic modules on your own.



### 3.6 Fire Safety

Please refer to local laws and regulations before installing modules and abide by requirements on building fire protection. According to the corresponding certification standards, the fire rating of LONGi monofacial module is UL type 1 or 2, and that of bifacial module is UL type 29.

The roof should be coated by a layer of fireproof materials with suitable fire protection rating for roofing installation and make sure that the back sheet and the mounting surface are fully ventilated.

Different roof structures and installation modes will affect fireproof performance of buildings. Improper installation may lead to the risk of fire.

To guarantee roof fire rating, the distance between module frame and roof surface must be  $\geq 10\text{cm}$ . (4in)

Adopt proper module accessories such as fuse, circuit breaker and grounding connector according to local regulations.

Please do not apply modules in where exposed inflammable gases are nearby.

## 4 Installation Conditions

### 4.1 Installation Site and Working Environment

- The modules cannot be used in space
- Do not manually focus sunlight with mirrors or magnifying glass onto modules.
- LONGi modules shall be installed on proper buildings or other appropriate places (such as ground, garage, building outer wall, roof, PV tracking system) but shall not be installed on any vehicles.
- Do not install modules at places that are possible to be flooded.
- LONGi suggests that modules be installed in the working environment with the temperature of  $-20^{\circ}\text{C}$  to  $50^{\circ}\text{C}$  of which is the monthly average highest and lowest temperature of the installation sites. The extreme working environment temperature for modules is  $-40^{\circ}\text{C}$  to  $85^{\circ}\text{C}$ .
- Make sure that installed modules do not suffer wind or snow pressure that exceeds the permissible maximum load limit.
- Modules shall be installed in places free from shadows throughout the year. Make sure there are no light-blocking obstacles in the installation sites.
- Carry out lightning protection for modules installed in places with frequent lightning and thunder.
- Do not install modules in places with possible inflammable gases.
- Modules cannot be used in environments with too much hails, snows, flue gas, air pollution and soot or in places with strong corrosive substances such as salt, salt mist, saline, active chemical steam, acid rain, or other substances corroding modules, affecting modules' safety or performance.
- Please take protective measures to ensure reliable and safe installation of modules in severe environments such as heavy snow, cold and strong wind or islands close to water and salt mist or deserts.
- LONGi modules passed the IEC61701 salt spray corrosion test, but the corrosion may still occur on where the modules frame is connected to the bracket or where the grounding is connected. In case LONGi modules are installed 50m –500m away from the ocean side, stainless steel or aluminum materials are need to be used to contact the PV modules, and the connection point should be protected with anti-corrosion measures.

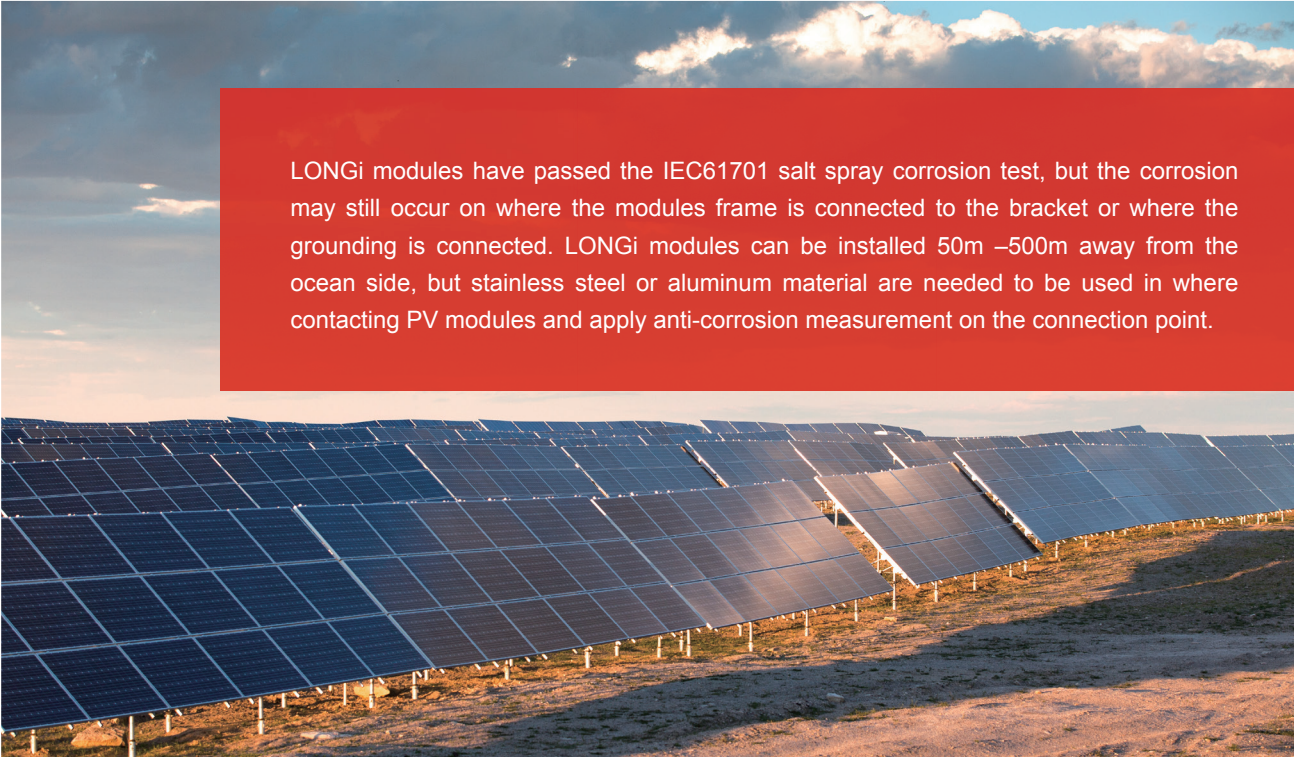

LONGi modules have passed the IEC61701 salt spray corrosion test, but the corrosion may still occur on where the modules frame is connected to the bracket or where the grounding is connected. LONGi modules can be installed 50m –500m away from the ocean side, but stainless steel or aluminum material are needed to be used in where contacting PV modules and apply anti-corrosion measurement on the connection point.

## 4.2 Selection of Tilt Angles

Tilt angle of modules: Included angle between module surface and horizontal surface; the module will obtain the maximum power output in direct facing of sunlight.

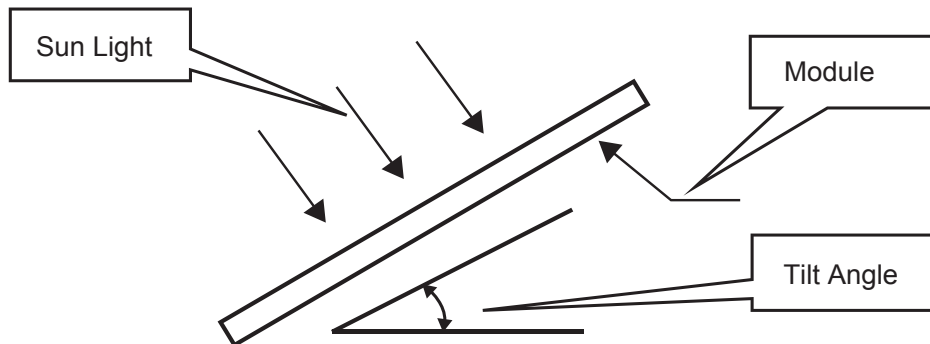

Modules are preferred to be south-facing in the north hemisphere and north-facing in the south hemisphere. Please refer to standard modules installation guideline or suggestions from experienced PV module installer, for the specific installation angle.

LONGi suggests that tilt angle of module installation be no less than  $10^\circ$ , so module surface dust can be washed away easily by rainfall and frequency of cleaning can be reduced. And it is easy for ponding to flow away and avoid water mark on the glass due to long time of water ponding which may further affect module appearance and performance.

LONGi modules connected in string should be installed with the same orientation and tilt angle. Different orientations and tilt angles may result in different received solar irradiation and output power loss. In order to achieve the maximum annual generating capacity, the optimal orientation and inclination of PV modules in the installed area should be selected to ensure that sunlight can still reach to modules even on the shortest day of the year.

If LONGi modules are used in off-grid System, the tilt angle should be calculated based on seasons and irradiation to maximize the output power. If the modules output power meets the acquired load under the period of the worst irradiation in the year, the modules should be able to meet the load of the whole year. If the LONGi modules are used in grid-connected system, the tilt angle should be calculated based on the principle to maximize the yearly output power.



## 5 Mechanical Installation

### 5.1 Regular Requirements

- Make sure that module installation mode and bracket system can meet the expected load, which is requisite assurance that the bracket installer must provide. Installation bracket system shall be tested and inspected by the third party testing institution with static mechanical analysis capacity in accordance with local national standards or international standards.
- Module bracket shall be made from durable, corrosion resistant, UV-proof materials.
- Modules shall be fixed on the bracket solidly.
- Use higher brackets in places with heavy snow accumulation so the lowest point of modules will not be shadowed by snow for a long time. In addition, make the lowest point of modules high enough so as to avoid shading of vegetation and woods or reduce damage of sands and stones.
- If modules are installed on brackets parallel to the roof or wall, the minimum gap between the module frame and the roof/wall shall be 10cm for air ventilation in case of module wire damage.
- Make sure the building is suitable for installation before installing modules on roof. Moreover, seal properly to prevent leakage.
- The module frames can appear thermal expansion and cold contraction so the frame interval between two adjoining modules shall be no less than 10mm.
- Make sure that backsheet of modules will not be in contact with bracket or building structures that can pierce into the inside of the modules, especially when the module surface is imposed by pressure.
- Maximum static load of the PV module is downforce 5400pa and uplift force 2400pa, which can vary from different mounting methods of the modules (please refer to the following installation guidance), the described load in this manual is for the test load.
- Note: on the basis of IEC61215 - 2016 installation requirements, when computing the corresponding maximum design load, need to consider the safety factor of 1.5 times.
- Modules can be installed horizontally or vertically. When installing the components, be cautious not to block the drain hole of the frame.

### 5.2 Monofacial assembly mechanical installation

Module and bracket system connection can be realized by mounting holes, clamps or embedded systems. Installation shall follow the demonstration and suggestions below. If installation mode is different, please consult LONGi and obtain approval. Otherwise, modules may be damaged and limited warranty will be invalid.



## 5.2.1 Bolts Mounting

Apply bolts to fix modules on the bracket through mounting holes on the back frame. See details in Figure 4.

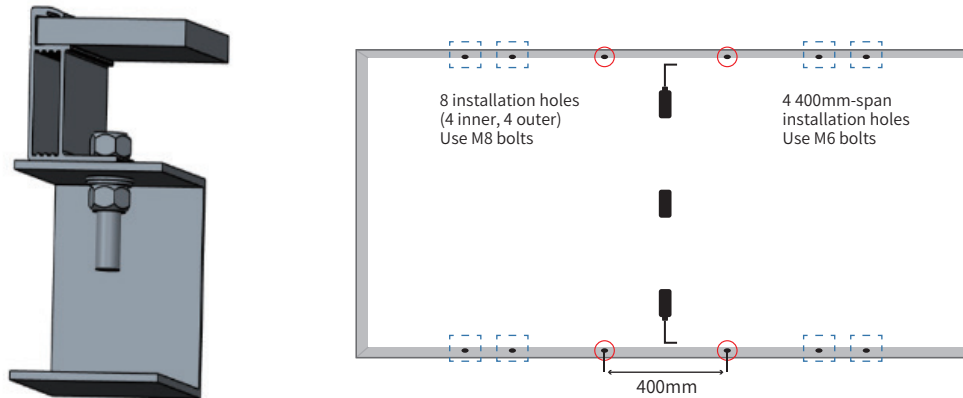

Figure 4 Bolt Installation of Monofacial Module

Recommended accessories are as below :

| Accessories   | Model                        |                              | Material     | Note   |
|---------------|------------------------------|------------------------------|--------------|--|
| Bolt          | M8 (full thread recommended) | M6 (full thread recommended) | Q235B/SUS304 | Accessories material selection should be based on application environment. |
| Washer        | 2*8                          | 2*6 (6.4*18-1.6 ISO 7093)    | Q235B/SUS304 |  |
| Spring Washer | 8                            | 6                            | Q235B/SUS304 |  |
| Nut           | M8                           | M6                           | Q235B/SUS304 |  |

- Suggestion : (1) M8 bolt tightening torque range: 12N•m-16N•m; M6 bolt tightening torque range: 8N•m-12N•m;  
 (2) When using LONGi 30mm (30H) height frame module, it is recommended to select  $L \leq 20\text{mm}$  length fasteners. (If there is a special model, consult LONGi customer service);

## 5.2.2 Clamp Mounting

The module can be mounted by a dedicated clamp, as shown in Figure 5.

Under no circumstances should the clamp touch the glass or deform the frame. The interface of the clamp to the front of the frame must be smooth and flat to prevent frame or other components from being damaged.

Make sure no shadowing effect of the fixture.

The drain hole cannot be blocked by the fixture.

For framed PV module, the clamp must maintain an overlap of 8-11 mm with the frame of the module (you can change the cross section of the clamp if the module is securely installed). For frameless PV module, the clamp must maintain an overlap of 15 mm at maximum with the module.

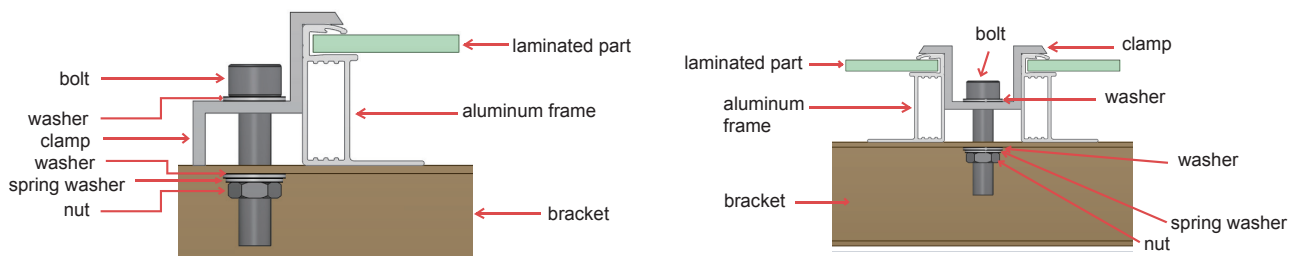

Figure 5 Clamp Installation of Monofacial Module

### 5.2.3 Installation and Mechanical Load of Monofacial Module

Monofacial modules can be installed with bolts into 4 outer installation holes, bolts into 4 inner installation holes, bolts into 400mm-span installation holes, and fixtures. Detailed installation positions and corresponding load capacities are shown in the table below.

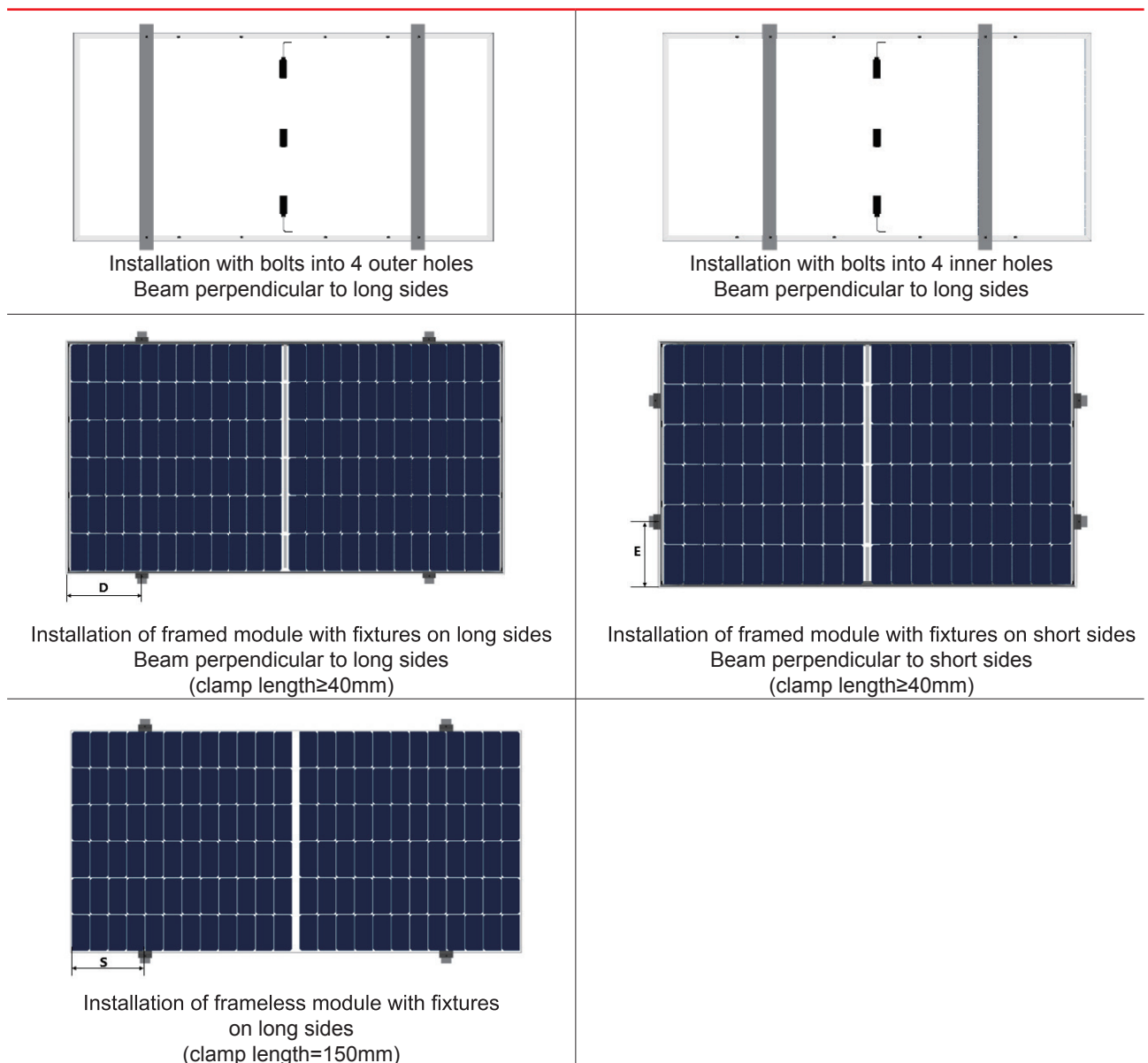

Figure 6 Monofacial Module Installation Annex



Load Capacities of Framed Monofacial Modules:

| Module Type                         | Installation Method              | Installation with bolts                          |  | Installation with fixtures                           |  |  |   |   |
|-------------------------------------|----------------------------------|--|--|--|--|--|---|---|
|                                     |                                  | 4 outer holes (beam perpendicular to long sides) | 4 inner holes (beam perpendicular to long sides) | 1/4L-50≤D≤1/4L+50 (beam perpendicular to long sides) | 300 ≤ D ≤ 400 (beam perpendicular to long sides) | 350≤D≤450 (beam perpendicular to long sides) | 150≤E≤250 (beam perpendicular to short sides) |   |
| 60/66-type Framed Monofacial Module | LR6-60-***M                      | ±2400  | +5400, -2400                                     | +5400, -2400   | /  | /  | ±2400   |   |
|                                     | LR6-60HV-***M                    | ±2400  | +5400, -2400                                     | +5400, -2400   | /  | /  | ±2400   |   |
|                                     | LR6-60BK-***M                    | ±2400  | +5400, -2400                                     | +5400, -2400   | /  | /  | ±2400   |   |
|                                     | LR6-60PE-***M                    | ±2400  | +5400, -2400                                     | +5400, -2400   | /  | /  | ±2400   |   |
|                                     | LR6-60PH-***M                    | ±2400  | +5400, -2400                                     | +5400, -2400   | /  | /  | ±2400   |   |
|                                     | LR6-60PB-***M                    | ±2400  | +5400, -2400                                     | +5400, -2400   | /  | /  | ±2400   |   |
|                                     | LR6-60MP-***M                    | ±2400  | +5400, -2400                                     | +5400, -2400   | /  | /  | ±2400   |   |
|                                     | LR6-60MPH-***M                   | ±2400  | +5400, -2400                                     | +5400, -2400   | /  | /  | ±2400   |   |
|                                     | LR6-60HPH-***M                   | ±2400  | +5400, -2400                                     | +5400, -2400   | /  | /  | ±2400   |   |
|                                     | LR6-60HPH-***MC                  | ±2400  | +5400, -2400                                     | +5400, -2400   | /  | /  | ±2400   |   |
|                                     | LR6-60HPB-***M                   | ±2400  | +5400, -2400                                     | +5400, -2400   | /  | /  | ±2400   |   |
|                                     | LR6-60HIH-***M                   | ±2400  | +5400, -2400                                     | +5400, -2400   | /  | /  | ±2400   |   |
|                                     | LR6-60HIB-***M                   | ±2400  | +5400, -2400                                     | +5400, -2400   | /  | /  | ±2400   |   |
|                                     | LR6-60DG-***M                    | ±2400  | +5400, -2400                                     | +5400, -2400   | /  | /  | ±2400   |   |
|                                     | LR6-60PD-***M                    | ±2400  | +5400, -2400                                     | +5400, -2400   | /  | /  | ±2400   |   |
|                                     | LR6-60HPD-***M                   | ±2400  | +5400, -2400                                     | +5400, -2400   | /  | /  | ±2400   |   |
|                                     | LR6-60OPH-***M                   | +5400, -2400                                     | ±2400  | /  | +5400, -2400                                     | /  | ±2400   |   |
|                                     | LR4-60HPH-***M                   | ±2400  | +5400, -2400                                     | +5400, -2400   | /  | /  | ±2400   |   |
|                                     | LR4-60HPB-***M                   | ±2400  | +5400, -2400                                     | +5400, -2400   | /  | /  | ±2400   |   |
|                                     | LR4-60HIH-***M                   | ±2400  | +5400, -2400                                     | +5400, -2400   | /  | /  | ±2400   |   |
|                                     | LR4-60HIB-***M                   | ±2400  | +5400, -2400                                     | +5400, -2400   | /  | /  | ±2400   |   |
|                                     | LR4-66HP-***M                    | +5400, -2400                                     | ±2400  | /  | /  | +5400, -2400                                 | ±2400   |   |
|                                     | LR4-66HPH-***M                   | +5400, -2400                                     | ±2400  | /  | /  | +5400, -2400                                 | ±2400   |   |
|                                     | LR4-66HIH-***M                   | +5400, -2400                                     | ±2400  | /  | /  | +5400, -2400                                 | ±2400   |   |
|                                     | LR5-66HPH-***M                   | +5400, -2400                                     | ±2400  | /  | /  | +5400, -2400                                 | /   |   |
|                                     | LR5-66HIH-***M                   | +5400, -2400                                     | ±2400  | /  | /  | +5400, -2400                                 | /   |   |
|                                     | 72-type Framed Monofacial Module | LR6-72-***M                                      | +5400, -2400                                     | ±2400  | +5400, -2400                                     | /  | /   | / |
|                                     |                                  | LR6-72HV-***M                                    | +5400, -2400                                     | ±2400  | +5400, -2400                                     | /  | /   | / |
| LR6-72BK-***M                       |                                  | +5400, -2400                                     | ±2400  | +5400, -2400   | /  | /  | /   |   |
| LR6-72PE-***M                       |                                  | +5400, -2400                                     | ±2400  | +5400, -2400   | /  | /  | /   |   |
| LR6-72PH-***M                       |                                  | +5400, -2400                                     | ±2400  | +5400, -2400   | /  | /  | /   |   |
| LR6-72PB-***M                       |                                  | +5400, -2400                                     | ±2400  | +5400, -2400   | /  | /  | /   |   |
| LR6-72MP-***M                       |                                  | +5400, -2400                                     | ±2400  | +5400, -2400   | /  | /  | /   |   |
| LR6-72MPH-***M                      |                                  | +5400, -2400                                     | ±2400  | +5400, -2400   | /  | /  | /   |   |
| LR6-72HPH-***M                      |                                  | +5400, -2400                                     | ±2400  | +5400, -2400   | /  | /  | /   |   |
| LR6-72HPH-***MC                     |                                  | +5400, -2400                                     | ±2400  | +5400, -2400   | /  | /  | /   |   |
| LR6-72HIH-***M                      |                                  | +5400, -2400                                     | ±2400  | +5400, -2400   | /  | /  | /   |   |
| LR6-72DG-***M                       |                                  | +5400, -2400                                     | ±2400  | +5400, -2400   | /  | /  | /   |   |
| LR6-72PD-***M                       |                                  | +5400, -2400                                     | ±2400  | +5400, -2400   | /  | /  | /   |   |
| LR6-72HPD-***M                      |                                  | +5400, -2400                                     | ±2400  | +5400, -2400   | /  | /  | /   |   |
| LR6-72OPH-***M                      |                                  | +5400, -2400                                     | ±2400  | /  | +5400, -2400                                     | /  | /   |   |
| LR4-72HPH-***M                      |                                  | +5400, -2400                                     | ±2400  | /  | /  | +5400, -2400                                 | /   |   |
| LR4-72HIH-***M                      |                                  | +5400, -2400                                     | ±2400  | /  | /  | +5400, -2400                                 | /   |   |
| LR5-72HPH-***M                      |                                  | +5400, -2400                                     | ±2400  | /  | /  | +5400, -2400                                 | /   |   |
| LR5-72HIH-***M                      |                                  | +5400, -2400                                     | ±2400  | /  | /  | +5400, -2400                                 | /   |   |

## Load Capacities of Frameless Monofacial Double-Glass Modules:

| Module Type | Installation Method | Installation with fixtures on long sides |           |
|-------------|---------------------|--|-----------|
|             |                     | 300≤S≤400                                | 400≤S≤500 |
| 60-type     | LR6-60PD-***M       | + 540Q-2400                              | /         |
|             | LR6-60DG-***M       | + 540Q-2400                              | /         |
|             | LR6-60HPD-***M      | + 540Q-2400                              | /         |
| 72-type     | LR6-72PD-***M       | /  | ±2400     |
|             | LR6-72DG-***M       | /  | ±2400     |
|             | LR6-72HPD-***M      | /  | ±2400     |

The compatible test load of monofacial modules and PV support brackets (tested by sandbags):

| Module Type  | Compatible Support Brackets   | Mounting Hardware  | Test Load (pa) |
|--|---|--|----------------|
| LR6-72PE-***M<br>LR6-72PH-***M<br>LR6-72HPH-***M<br>LR6-72HIH-***M<br>LR6-72OPH-***M | NEXTracker NX Horizon   | Short Rail V2.3, 4×bobtails (M6 head O.D. 16.8 mm), (400mm holes position)                 | ±2400          |
| LR4-72HPH-***M<br>LR4-72HIH-***M   | NEXTracker NX Horizon   | Short Rail V2.3, 4×bobtails (M6 head O.D. 16.8 mm), (400mm holes position)                 | ±2400          |
|  |   | Short Rail V2.4, 4×bobtails (M6 head O.D. 16.8 mm), (400mm holes position)                 | +1200<br>-2400 |
|  |   | Short Rail V2.4 + Module Bumper, 4×bobtails (M6 head O.D. 16.8 mm), (400mm holes position) | ±2400          |
|  | ATI DuraTrack™HZ Tracking System  | Hi-rise 300mm Clamp 20822  | ±1500          |
|  |   | Hi-rise 400mm Clamp 20834  | ±1600          |
|  |   | 600mm Clamp 20715  | ±2800          |
| Arctech single-axis tracker Portrait two rows SkySmart2                              | 3214*30*80*26*1.5mm rail + 900*32*38*2.0mm diagonal brace, M8 bolt+M8 plain washer(O.D.=16mm), 990mm holes position | ±2000  |                |
| Soltec SF7 Single-Axis Tracker Portrait two rows                                     | 2530mm rail, M6 bolt+M6 plain washer (O.D.=18mm), Drawing No: SF7-MR-06-091 Rev.D00, 400 + 1300mm holes position    | +1200<br>-1800   |                |
| LR5-66HPH-***M<br>LR5-66HIH-***M   | NEXTracker NX Horizon   | Short RailV2.4 + Module Bumper, 4×bobtails (M6 head O.D. 16.8 mm), (400mm holes position)  | ±2400          |
| LR5-72HPH-***M<br>LR5-72HIH-***M   | NEXTracker NX Horizon   | Short RailV2.4 + Module Bumper, 4×bobtails (M6 head O.D. 16.8 mm), (400mm holes position)  | ±2400          |

## 5.3 Bifacial module Mechanical Installation

Modules and mounting system can be connected by bolts, clamps or embedded systems. Installation shall follow the demonstration and suggestions below. If installation mode is different, please consult LONGi and obtain approval. Otherwise, modules could be damaged and quality warranty will be invalid.

### 5.3.1 Bolts Mounting

Apply bolts to fix modules on the bracket through mounting holes on the back frame. See details in Figure 7. A is the overlapping size of module frame and bracket.

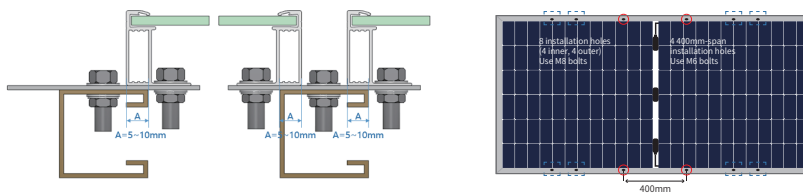

Figure 7 Bolt Installation of Bifacial Module



Recommended accessories are as below :

| Accessories   | Model                        |                              | Material     | Note   |
|---------------|------------------------------|------------------------------|--------------|--|
| Bolt          | M8 (full thread recommended) | M6 (full thread recommended) | Q235B/SUS304 | Accessories material selection should be based on application environment. |
| Washer        | 2*8                          | 2*6 (6.4*18-1.6 ISO 7093)    | Q235B/SUS304 |  |
| Spring Washer | 8                            | 6                            | Q235B/SUS304 |  |
| Nut           | M8                           | M6                           | Q235B/SUS304 |  |

- Suggestion : (1) M8 bolt tightening torque range: 12N•m-16N•m; M6 bolt tightening torque range: 8N•m-12N•m;  
 (2) When using LONGi 30mm (30H) height frame module, it is recommended to select  $L \leq 20\text{mm}$  length fasteners. (If there is a special model, consult LONGi customer service);



### 5.3.2 Clamps Installation

See details in Figure 8.

The clamp shall not be in touch with glass or deform module frame in any case. The interface of the clamp and frame front side shall be flat and smooth to prevent frame and module being damaged.

Avoid the shadow blocking effect of the clamp.

The drain hole cannot be blocked by the clamp. For framed PV module, the clamp must maintain an overlap of at least 8 mm but no more than 11 mm with the frame of the module (you can change the cross section of the fixture if the module is securely installed). For frameless PV module, the clamp must maintain an overlap of 15 mm at maximum with the module.

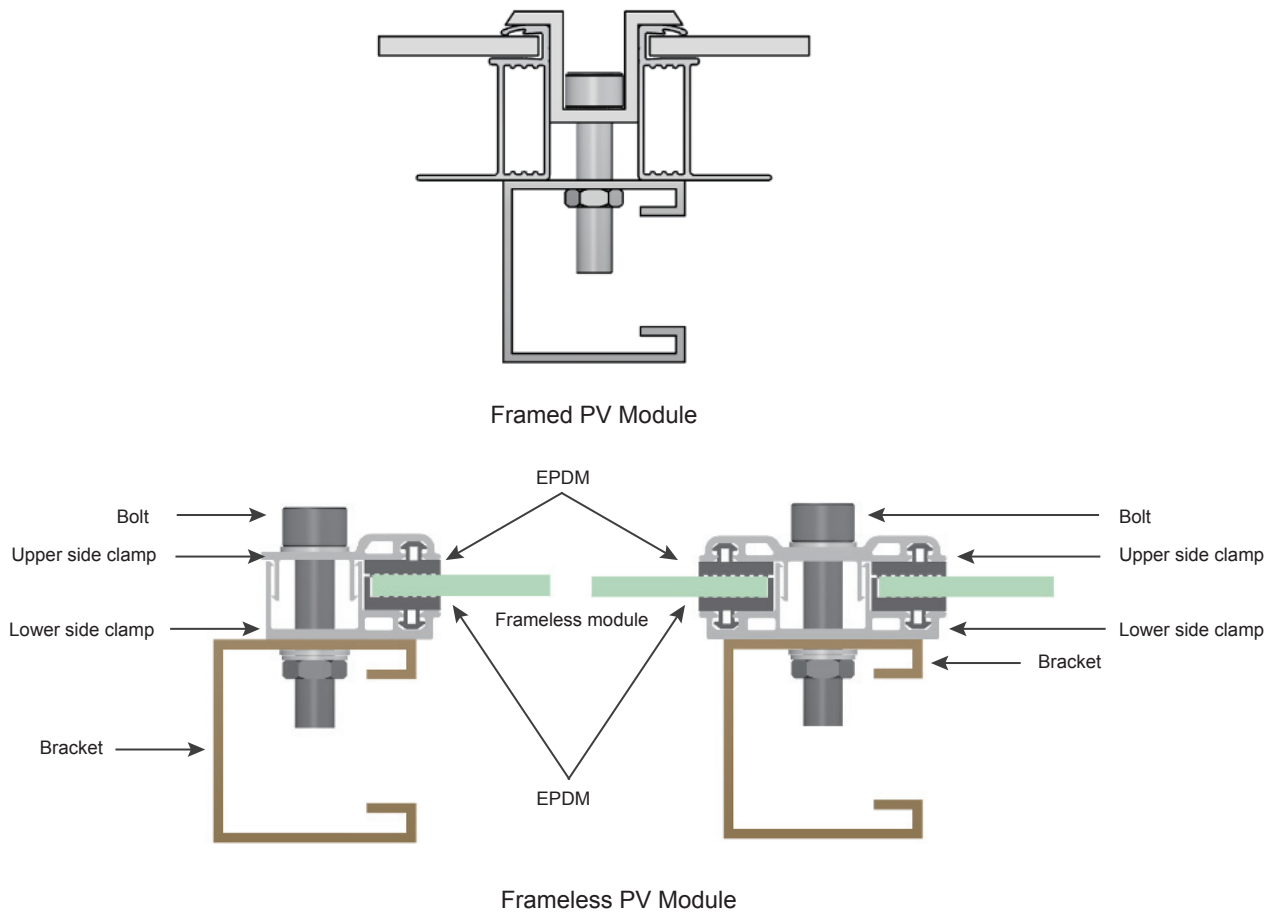
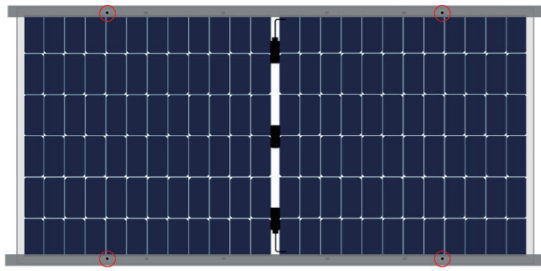

Figure 8 Clamp Installation of Bifacial Module



### 5.3.3 Installation and Mechanical Load of Bifacial Module

Bifacial modules can be installed with bolts into 4 outer installation holes, bolts into 4 inner installation holes, bolts into 400mm-span installation holes, and fixtures. Detailed installation positions and corresponding load capacities are shown in the table below.



Installation with bolts into 4 outer holes  
(Beam parallel to long sides)

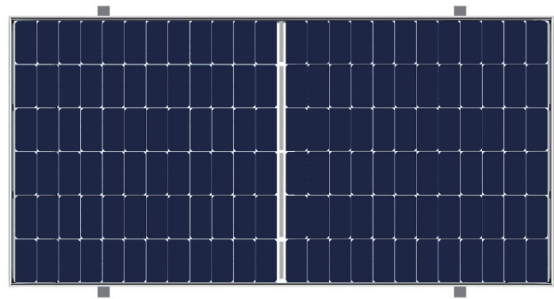

Installation with bolts into 4 outer holes  
(Beam perpendicular to long sides)

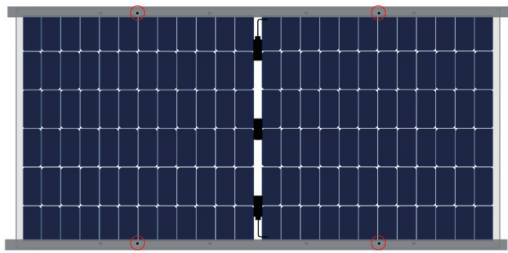

Installation with bolts into 4 inner holes  
(Beam parallel to long sides)

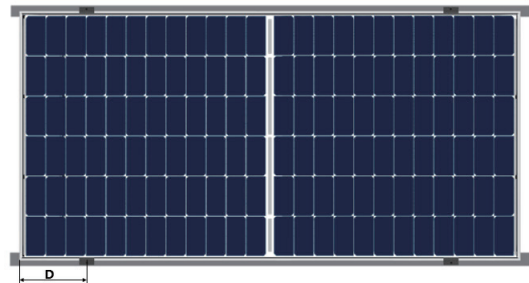

Installation of framed module with fixtures on long sides  
(beam parallel to long sides)  
(clamp length  $\geq 40\text{mm}$ )

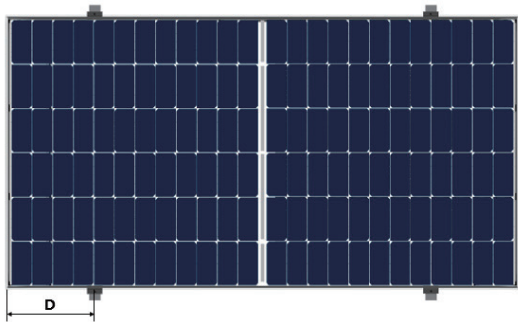

Installation of framed module with fixtures on long sides  
(beam perpendicular to long sides)  
(clamp length  $\geq 40\text{mm}$ )

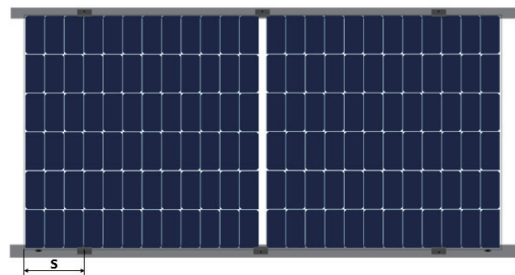

Installation of frameless module with fixtures on long sides  
(clamp length =  $150\text{mm}$ )

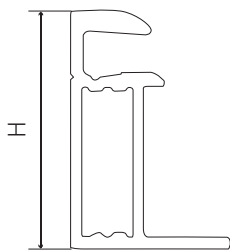

Aluminum Frame Height (H)

Figure 9 Bifacial Module Installation Annex

## Load Capacities of Framed Bifacial Double-Glass Modules:

| Module Type                                    | Installation Method       | Installation with bolts                     |  |   | Installation with fixtures                      |   |  |
|--|---------------------------|---|--|---|---|---|--|
|  |                           | 4 outer holes (beam parallel to long sides) | 4 outer holes (beam perpendicular to long sides) | 4 inner holes (beam parallel to long sides) | 1/4L-50≤D≤1/4L+50 (beam parallel to long sides) | 350≤D≤450 (beam parallel to long sides) | 350≤D≤450 (beam perpendicular to long sides) |
| 60/66-type Framed Bifacial Double-Glass Module | LR6-60BP-***M (40H/30H)   | ±2400                                       | /  | +5400,-2400                                 | +5400,-2400                                     | /                                       | /  |
|  | LR6-60BP-***M (25H)       | ±2400                                       | /  | ±2400                                       | ±2400   | /                                       | /  |
|  | LR6-60HBD-***M (40H/30H)  | ±2400                                       | /  | +5400,-2400                                 | +5400,-2400                                     | /                                       | /  |
|  | LR6-60HBD-***MC (40H/30H) | ±2400                                       | /  | +5400,-2400                                 | +5400,-2400                                     | /                                       | /  |
|  | LR6-60HIBD-***M           | ±2400                                       | /  | +5400,-2400                                 | +5400,-2400                                     | /                                       | /  |
|  | LR6-60OPD-***M            | ±2400                                       | /  | +5400,-2400                                 | +5400,-2400                                     | /                                       | /  |
|  | LR4-60HBD-***M (30H)      | ±2400                                       | /  | +5400,-2400                                 | +5400,-2400                                     | /                                       | /  |
|  | LR4-60HIBD-***M           | ±2400                                       | /  | +5400,-2400                                 | +5400,-2400                                     | /                                       | /  |
|  | LR5-66HBD-***M            | +3600,-2400                                 | +5400,-2400                                      | ±2400                                       | /   | +3600,-2400                             | +5400,-2400                                  |
| LR5-66HIBD-***M                                | +3600,-2400               | +5400,-2400                                 | ±2400  | /   | +3600,-2400                                     | +5400,-2400                             |  |
| 72-type Framed Bifacial Double-Glass Module    | LR6-72BP-***M (40H/30H)   | +5400,-2400                                 | /  | ±2400                                       | +5400,-2400                                     | /                                       | /  |
|  | LR6-72BP-***M (25H)       | ±2400                                       | /  | ±2400                                       | ±2400   | /                                       | /  |
|  | LR6-72HBD-***M (40H/30H)  | +5400,-2400                                 | /  | ±2400                                       | +5400,-2400                                     | /                                       | /  |
|  | LR6-72HBD-***MC (40H/30H) | +5400,-2400                                 | /  | ±2400                                       | +5400,-2400                                     | /                                       | /  |
|  | LR6-72HIBD-***M           | +5400,-2400                                 | /  | ±2400                                       | +5400,-2400                                     | /                                       | /  |
|  | LR6-72OPD-***M            | +5400,-2400                                 | /  | ±2400                                       | +5400,-2400                                     | /                                       | /  |
|  | LR4-72HBD-***M (35H)      | +5400,-2400                                 | /  | ±2400                                       | +5400,-2400                                     | /                                       | /  |
|  | LR4-72HIBD-***M           | +5400,-2400                                 | /  | ±2400                                       | +5400,-2400                                     | /                                       | /  |
|  | LR6-78HBD-***M (40H)      | +5400,-2400                                 | /  | ±2400                                       | +5400,-2400                                     | /                                       | /  |
|  | LR5-72HBD-***M            | +3600,-2400                                 | +5400,-2400                                      | ±2400                                       | /   | +3600,-2400                             | +5400,-2400                                  |
| LR5-72HIBD-***M                                | +3600,-2400               | +5400,-2400                                 | ±2400  | /   | +3600,-2400                                     | +5400,-2400                             |  |

## Load Capacities of Frameless Monofacial Double-Glass Modules:

| Module Type | Installation Method | Installation with fixtures on long sides |           |
|-------------|---------------------|--|-----------|
|             |                     | 300≤S≤400                                | 400≤S≤500 |
| 60-type     | LR6-60BP-***M       | ±2400                                    | /         |
|             | LR6-60HBD-***M      | ±2400                                    | /         |
| 72-type     | LR6-72BP-***M       | /  | ±2400     |
|             | LR6-72HBD-***M      | /  | ±2400     |

## The compatible test load of bifacial modules and PV support brackets (tested by sandbags):

| Module Type   | Compatible Support Brackets       | Mounting Hardware  | Test Load (pa)  |  |
|---|-----------------------------------|--|---|--|
| LR6-72BP-***M<br>LR6-72HBD-***M<br>LR6-72HIBD-***M<br>LR6-78HBD-***M                                  | NEXTracker NX Horizon             | Short Rail V2.4, 4×bobtails (M6 head O.D. 16.8 mm), (400mm holes position) | ±2400   |  |
|   | NEXTracker NX Horizon             | Short Rail V2.4, 4×bobtails (M6 head O.D. 16.8 mm), (400mm holes position) | ±2400   |  |
|   |                                   | Hi-rise 300mm Clamp 20822  | ±1500   |  |
|   |                                   | Hi-rise 400mm Clamp 20834  | ±1500   |  |
|   |                                   | 600mm Clamp + Clamp Ear 80mm 20908   | ±2400   |  |
| 600mm Clamp 20715   |                                   | ±2800  |   |  |
| LR4-72HBD-***M<br>LR4-72HIBD-***M   | ATI DuraTrack™ HZ Tracking System | 850mm Clamp + Clamp Ear 80mm 20904   | ±3000   |  |
|   |                                   | Arctech single-axis tracker Portrait two rows SkySmart2                    | 3214*30*80*26*1.5mm rail + 900*32*38*2.0mm diagonal brace, M8 bolt+M8 plain washer(O.D.=16mm), 990mm holes position | ±2400  |
|   |                                   | Soltec SF7 Single-Axis Tracker Portrait two rows                           | 2530mm rail, M6 bolt+M6 plain washer (O.D.=18mm), Drawing No: SF7-MR-06-091 Rev.D00, 400 + 1300mm holes position    | ±1800  |
|   |                                   | LR5-66HBD-***M<br>LR5-66HIBD-***M  | NEXTracker NX Horizon   | Short Rail V2.4, 4×bobtails (M6 head O.D. 16.8 mm), (400mm holes position) |
| Short Rail V2.4, 4×bobtails (M6 head O.D. 16.8 mm), (400mm holes position)                            | ±2100                             |  |   |  |
| Short Rail V2.4 + 990mm Supplement Rail, 8× bobtails (M6 head O.D. 16.8 mm), 400+990mm holes position | ±2400                             |  |   |  |
| Hi-rise 300mm Clamp 20822   | ±1200                             |  |   |  |
| Hi-rise 400mm Clamp 20834   | ±1200                             |  |   |  |
| LR5-72HBD-***M<br>LR5-72HIBD-***M   | ATI DuraTrack™ HZ Tracking System | 600mm Clamp + Clamp Ear 80mm 20908   | ±1900   |  |
|   |                                   | 850mm Clamp + Clamp Ear 80mm 20904   | ±2400   |  |
|   |                                   | 1400mm Rail 20916  | ±3600   |  |
|   |                                   | Soltec SF7 Single-Axis Tracker Portrait two rows                           | 2832mm rail, M6 bolt+M6 plain washer (O.D.=18mm), Drawing No: SF7-MR-06-064 Rev.P00, 400 + 1400mm holes position    | ±1800  |

## 6 Electrical installation

### 6.1 Electrical Performance

The reported performance measurements are subject to +/-3% uncertainty at STC (1000 W/m<sup>2</sup> Irradiance, a cell temperature of 25 °C and an AM1.5 spectrum) for voltage, current and power..

When modules are in series connection, the string voltage is sum of every individual module in one string. When modules are in parallel connection, the current is sum of the individual module as shown in below figure 10. Modules with different electric performance models can not be connected in one string.

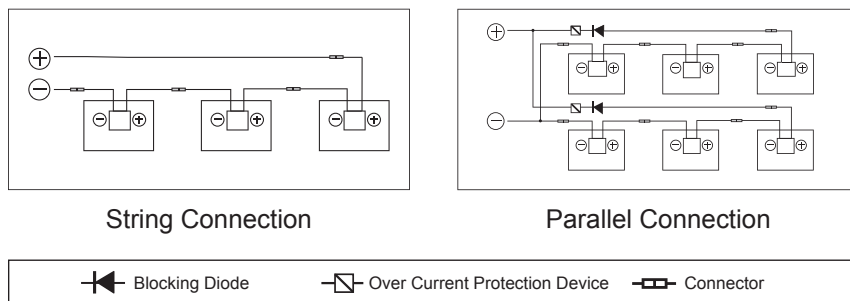

Figure 10 Series Connection and Parallel Connection Circuit Diagram

The maximum allowed quantity of modules in string connection shall be calculated according to relative regulations. The open circuit voltage value under the expected lowest temperature shall not exceed the maximum system voltage value allowed by modules and other values required by DC electric parts. (LONGi modules maximum system voltage is DC1000V/DC1500V---actually system voltage is designed based on the selected module and inverter model.)

The VOC factor can be calculated by the following formula.

$$CV_{oc} = 1 - \beta V_{oc} \times (25 - T)$$

T: The expected lowest temperature of the installation site.

$\beta$ : VOC temperature coefficient (% / °C) (Refer to modules data sheet for further detail)

If there is reverse current exceeding the maximum fuse current flowing through the module, use overcurrent protection device with the same specifications to protect the module; if parallel connection are more than 2, there must be an overcurrent protection device on each string of module. See Figure 5.



## 6.2 Cables and Wiring

In module design, adopt junction boxes with the protective level of IP67 for on-site connection to provide environmental protection for wires and connections and contacting protection for non-insulating electric parts. The junction box perform the protective level of IP67 with well connected cables and connectors. These designs facilitate parallel connection of modules. Each module has two individual wires connecting the junction box, one is negative pole and the other is positive pole. Two modules can be in series connection by inserting the positive pole at one end of wire of one module into the negative pole of the adjoining module. According to local fire protection, building and electrical regulation, apply proper cable and connector; ensure the electrical and mechanical property of the cables (the cables should be put in a catheter with anti-UV aging properties, and if exposed to air, the cable itself should have anti-UV aging capability).

The installer can only use single-wire cable, 2.5-16mm<sup>2</sup>(5-14 AWG), 90 °C , with proper insulation capability to withstand the maximum open circuit voltage (such as EN50618 approval). Need to select appropriate wire specifications to reduce voltage drop.

LONGi requires that all wiring and electrical connections comply with the appropriate 'National Electrical Code'.

When cables are fixed on the bracket, avoid mechanical damaging cables or modules. Do not press cables by force. Adopt UV resistant cable ties and clamps to fix cables on the bracket. Though cables are UV resistant and water proof, it is still necessary to prevent cables from direct sun light and water immersion.

The minimum bending radius of cables should be 43mm. (1.69in)

### 6.3 Connector

Please keep connectors clean and dry. Make sure connector caps are fastened before connection. Do not connect connectors under improper conditions of damp, dirty or other exceptional situations ). Avoid connectors from direct sun light and water immersion or falling onto ground or roof.

Incorrect connection may lead to electric arc and electric shock. Please make sure that all electric connection is reliable. Make sure all connectors are fully locked.

Only compatible connectors can be mated, i.e. from the same vendor and model, shall be used;(If you need to use different types of connectors, please consult customer service of LONGi solar );.

### 6.4 Bypass diode

LONGi solar module junction box contains bypass diode which is in parallel connection with the cell string. If hot spot occurred, the diode will come into operation to stop the main current from flowing through the hot spot cells in order to prevent module over-heated and performance loss. Notice, bypass diode is not the overcurrent protection device.

If the diode is definite or suspected to be defective, the installer or system maintenance supplier shall contact LONGi.

Please do not try to open the module junction box on your own.



### 6.5 PID Protection and Inverter Compatibility

- ① PV modules may appear Potential Induced Degradation (PID) under high humidity, high temperature and high voltage condition. Modules may appear Potential Induced Degradation (PID) under the conditions below:
  - ◇ PV modules install under hot and humid weather condition.
  - ◇ PV modules installation site is under long term humid condition such as floating PV system.
- ② To reduce the risk of PID, on the modules DC connection site, it is recommended to connect the negative to ground. The PID protection measures on system level are recommended as follow
  - ◇ For isolated PV inverter, the negative of the PV modules DC connection side can be directly grounded.
  - ◇ For non-isolated PV inverter, isolated transformer is needed to be installed before applying virtual grounding (grounding method guidance from the inverter manufactures are usually needed)



## **7** Grounding

In design of modules, the anodized corrosion resistant aluminum alloy frame is applied for rigidity support. For safety utilization and to protect modules from lightning and static-electricity damage, the module frame must be grounded. The grounding device must be in full contact with inner side of the aluminum alloy and penetrate surface oxide film of the frame.

Do not drill additional grounding holes on module frame.

The grounding conductor or wire may be copper, copper alloy, or any other material acceptable for application as an electrical conductor per respective National Electrical Codes. The grounding conductor must then make a connection to ground with a suitable ground electrode.

Holes marked with a grounding mark on the frame can only be used for grounding but not for mounting.

Frameless double glass modules have no exposed conductor, and therefore according to regulations it did not need to be grounded.



### **Grounding methods below are permissible**

#### **1 Grounding by grounding clamp**

There is a grounding hole with the diameter of  $\text{Ø}4.2$  mm at the edge of the module back frame. The central line of the grounding sign also located on the edge of the module back frame overlaps with that of the grounding hole.

Grounding between modules shall be confirmed by qualified electricians and grounding devices shall be manufactured by qualified electric manufacturer. The torque of copper core wire used for the grounding clamp is recommended to be  $2.3\text{N}\cdot\text{m}$ . 12 AWG. And copper wires cannot be pressed during installation in case of damaging.

#### **2 Grounding by unoccupied mounting holes**

Mounting holes on modules that are not occupied can be used for installing grounding components.

- ◆ Align grounding clamp to the frame mounting hole. Use grounding bolt to go through the grounding clamp and frame.
- ◆ Put the tooth side of the washer on the other side and fasten the nuts.
- ◆ Put grounding wires through the grounding clamp and grounding wire material and dimension shall meet requirements in local national and regional law and regulations.
- ◆ Fasten bolts of grounding wires and then installation is completed.

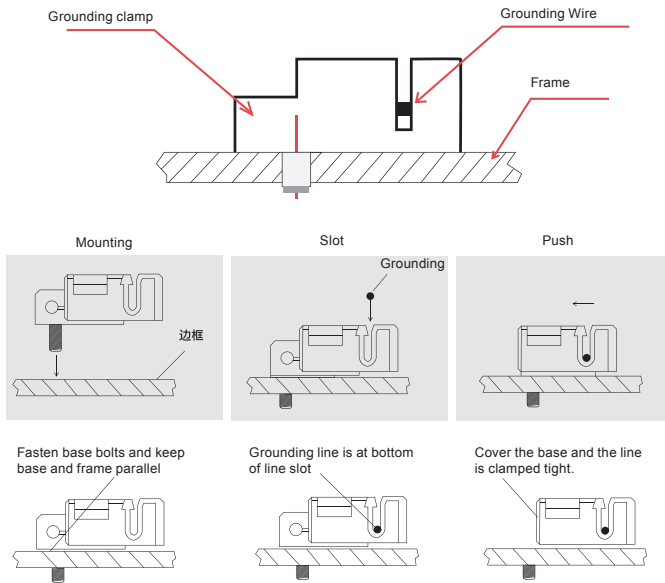

Figure 11 Clamp Grounding Method

Note: TYCO. 1954381-1 (Recommended) is used in figures above.

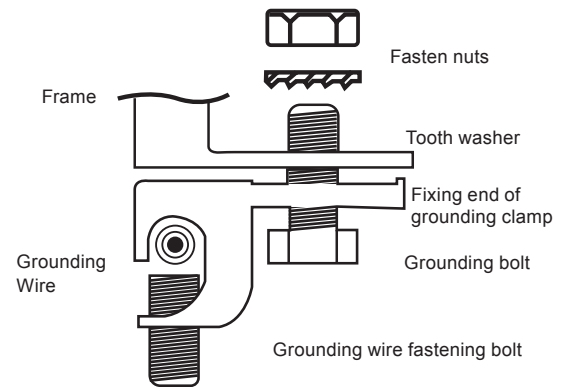

Figure 12 Bolt Grounding Method

### 3 The third party grounding devices

The third party grounding device can be used for grounding of LONGi modules but such grounding shall be proved to be reliable. Grounding device shall be operated in line with stipulations of the manufacturer.

## 8 Operation and maintenance

It is the users' responsibility to carry out regular inspection and maintenance for modules, especially during the period of limited warranty; inform the supplier within two weeks when modules are found broken.

### 8.1 Cleaning

Accumulated contaminants on module surface glass will reduce the power output and lead to local hot spot, such as dust, industrial wasted water and birds' droppings. The severity of influence is determined by transparency of wastes. Small amounts of dust will affect the intensity and evenness of received solar irradiation but are not dangerous and power will not be reduced remarkably generally.



During operation of modules, there shall be no environmental factors to shade modules fully or partially. These environment factors including other modules, module mounting system, birds dwelling, dust, soil or plants. These will significantly reduce output power. LONGi suggests that the module surface should not be shadowed in any case.

Frequency of cleaning depends on dirt accumulation speed. In normal situations, rainwater will clean the module surface and reduce the cleaning frequency. It is suggested to use sponge dipped with clean water or soft cloth to wipe the glass surface. Do not use acid and alkaline detergents to clean modules. Do not use tool with rough surface to clean in any case.

In order to avoid potential risk of electrical shock or burn, LONGi suggests cleaning the modules during early morning and evening with low irradiance and low modules temperature especially area with high average temperature.

In order to avoid potential risk of electrical shock, do not try to clean the modules with glass damage or expose wires.



## 8.2 Module Appearance Inspection

Check module cosmetic defects with naked eyes , especially:

- ◆ Module glass cracks.
- ◆ Corrosion at welding parts of the cell main grid (caused by moisture into the module due to damage of sealing materials during installation or transportation).
- ◆ Check whether there are traces of burning mark on the module back sheet.
- ◆ Check PV modules if any signs of aging including rodent damage, climate aging, connectors tightness, corrosion and grounding condition.
- ◆ Check if any sharp objects in contact with PV modules' surface
- ◆ Check if any obstacles shading the PV modules
- ◆ Check if any loose or damage screws between the modules and mounting system. If so, adjust and fix in time.

## 8.3 Inspection of Connectors and Cables

It is suggested to carry out the following preventive inspection twice a year:

- ◆ Check if any crack or gap of silicone nearby the junction box.



## 9 Release and execution

This manual document is implemented and managed by product management department. Product management department reserves the right to modify and revise in any time.



**LONGi**

**LONGi Solar Technology Co, Ltd.**

No.8369 Shangyuan Road, Xi'an Economic & Technological  
Development Zone

[www.longi-solar.com](http://www.longi-solar.com)