

ABB solar inverters

Product manual

TRIO-5.8/7.5/8.5-TL-OUTD

(5.8 to 8.5 kW)





IMPORTANT SAFETY INSTRUCTIONS

This manual contains important safety instructions that must be followed during installation and maintenance of the equipment.



Operators are required to read this manual and scrupulously follow the indications reported in it, since ABB cannot be held responsible for damages caused to people and/or things, or the equipment, if the warranty conditions are not observed.

Product Manual

TRIO-5.8/7.5/8.5 string inverters

1 - Introduction and general information



2 - Characteristics



3 - Safety and accident prevention



4 - Lifting and transport



5 - Installation



6 - Instruments



7 - Operation



8 - Maintenance



Warranty and Supply Conditions

The warranty conditions are considered to be valid if the customer adheres to the indications in this manual; any conditions deviating from those described herein must be expressly agreed in the purchase order.

The equipment complies with the pertinent legislation currently in force in the country of installation and it has issued the corresponding declaration of conformity.

Not included in the supply



ABB accepts no liability for failure to comply with the instructions for correct installation and will not be held responsible for systems upstream or downstream the equipment it has supplied. It is absolutely forbidden to modify the equipment. Any modification, manipulation, or alteration not expressly agreed with the manufacturer, concerning either hardware or software, shall result in the immediate cancellation of the warranty.

The Customer is fully liable for any modifications made to the system.

Given the countless array of system configurations and installation environments possible, it is essential to check the following: sufficient space suitable for housing the equipment; airborne noise produced depending on the environment; potential flammability hazards.

ABB will NOT be held liable for defects or malfunctions arising from: improper use of the equipment; deterioration resulting from transportation or particular environmental conditions; performing maintenance incorrectly or not at all; tampering or unsafe repairs; use or installation by unqualified persons.

ABB will NOT be held responsible for the disposal of: displays, cables, batteries, accumulators etc. The Customer shall therefore arrange for the disposal of substances potentially harmful to the environment in accordance with the legislation in force in the country of installation.

Contents

Introduction and general information	4
Warranty and Supply Conditions	4
Not included in the supply.....	4
Contents	5
Reference number index	8
Graphical representation of references	8
The document and who it is for	9
Purpose and structure of the document	9
List of annexes	9
Staff characteristics.....	9
Symbols and signs	10
Field of use, general conditions	11
Intended or allowed use.....	11
Limits in field of use.....	11
Improper or prohibited use	11
Characteristics	12
General conditions	12
Models and range of equipment	13
Identification of the equipment and the manufacturer	14
Inverter Composition	16
5.8kW Standard / -S Version	16
7.5kW and 8.5kW Standard / -S Version.....	17
Accessory components (installable on the inverter)	18
“Wifi Logger Card” accessory card	18
“ETHERNET Expansion Board” accessory board.....	19
“PMU Expansion Board” accessory board	19
Characteristics and technical data	20
Tightening torques	22
Overall dimensions	22
Bracket dimensions.....	23
Efficiency curves	24
Power derating	25
Power derating due to environmental conditions	26
Power reduction due to the input voltage	26
Characteristics of a photovoltaic generator	27
Strings and Arrays.....	27
Description of the equipment	28
Operating diagram	28
Connection of several inverters together.....	29
Notes on the sizing of the system.....	29
Functionality and components of the equipment	30
Topographic diagram of the equipment	32
Safety devices	34
Anti-Islanding	34
Ground fault of the photovoltaic panels	34
Other safety devices	34



Safety and accident prevention	35
Safety instructions and general information	35
Hazardous areas and operations	36
Environmental conditions and risks	36
Signs and Labels	36
Thermal hazard	37
Clothing and protective devices for staff	37
Residual risks	38
Table of residual risks	38
Lifting and transport	39
General conditions	39
Transport and handling	39
Lifting	39
Unpacking and checking	39
List of components supplied	40
Weight of the groups of device	41
Installation	42
General conditions	42
Environmental checks	43
Installations above 2000 metres	43
Installation position	44
Wall mounting	45
Opening the front cover	46
Operations preparatory to PV generator connection	47
Checking the correct polarity of the strings	47
Checking of leakage to ground of the photovoltaic generator	47
Choice of differential protection downstream of the inverter	47
Independent or parallel input channels configuration	49
Channel configuration examples	50
Independent channel configuration (default configuration)	51
Parallel channel configuration	51
Input connection to PV generator (DC side)	53
Connection of inputs - Standard Models	53
Connection of inputs - Models with disconnect switch (-S)	54
Installation procedure for quick fit connectors	56
Grid output connection (AC side)	58
Characteristics and sizing of the protective earthing cable	58
Load protection switch (AC disconnect switch)	58
Characteristics and sizing of the line cable	59
Connection to terminal block AC side	59
Installation of the second protective earthing cable	60
Communication and control board	61
Connections to the communication and control board	62
Remote control connection	62
Configurable Relay connection (ALARM)	63
Serial Connection Communication (RS485 PC)	64
Monitoring and control systems	65
Procedure for RS485 connection to a monitoring system	65
Closing the front cover	66



Instruments	67
General conditions	67
Display and keyboard	68
Display fields and symbols description.....	68
Description of keyboard and LED Panel.....	69
Operation	70
General conditions	70
Monitoring and data transmission	71
User interface mode.....	71
Types of data available	71
Measurement tolerance	71
Commissioning	72
Display access and settings	75
Updating the firmware from an SD card	75
Dynamic display behaviour.....	76
LED behaviour	77
Specifications on the operation of the LEDs.....	78
LED insulation fault.....	78
Description of the menus	79
General information	79
Statistics Menu.....	81
Settings Menu	83
Info Menu	92
AUTOTEST procedure in accordance with standard CEI 0-21	93
Running the tests from the display menu	93
Inverter switch-off	95
Maintenance	96
General conditions	96
Routine maintenance	97
Troubleshooting	97
Alarm Messages	97
Power limitation messages.....	104
Putting the inverter out of service	106
Registration on “Registration” website and calculation of second-level password (Service Menu)	107
Resetting the time remaining to change the grid standard	110
Replacement of the buffer battery	111
Verification of ground leakage	112
Behaviour of a system without leakage	112
Behaviour of a system with leakage	113
Measuring the insulation resistance of photovoltaic generator	114
Storage and dismantling	115
Storage of the equipment or prolonged stop	115
Dismantling, decommissioning and disposal.....	115
Further information	116
Contact us	117



Reference number index

- | | | |
|-------------------------------------|--------------------------|------------------------------|
| 01, display | 08, DC disconnect switch | 15, AC cable gland |
| 02, LED panel | 09, bracket anchor hole | 16, service cable glands |
| 03, keyboard | 10, inverter | 17, anti-condensation valve |
| 04, front cover | 11, handles | 18, DC cable gland |
| 05, AC output board | 12, heat sink | 19, input connectors (MPPT1) |
| 06, communication and control board | 13, bracket | 20, input connectors (MPPT2) |
| 07, DC input board | 14, locking screw | |



Graphical representation of references

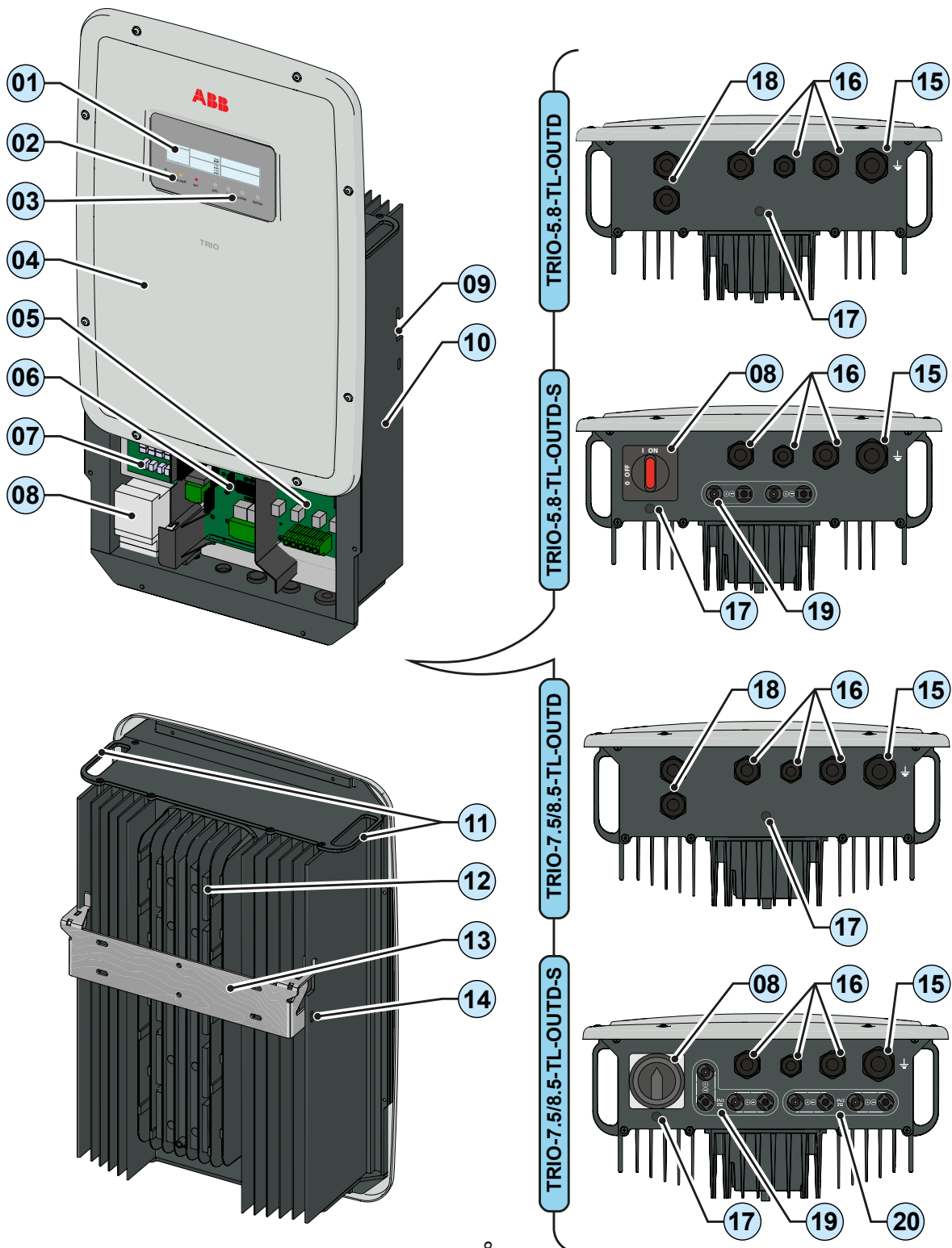

The document and who it is for

Purpose and structure of the document

This operating and maintenance manual is a useful guide that will enable you to work safely and carry out the operations necessary for keeping the equipment in good working order.



If the equipment is used in a manner not specified in the installer manual, the protection provided by the equipment may be impaired.



The language in which the document was originally written is ITALIAN; therefore, in the event of inconsistencies or doubts please ask the manufacturer for the original document.

List of annexes

In addition to this operating and maintenance manual, (if applicable or on request) the following enclosed documentation is supplied:

- EC declaration of conformity
- quick installation guide



WARNING: Part of the information given in this document is taken from the original documents of the suppliers. This document contains only the information considered necessary for the use and routine maintenance of the equipment.

Staff characteristics



The customer must make sure that the operator has the necessary skill and training to do his/her job. Personnel in charge of using and maintaining the equipment must be expert, aware and skilled for the described tasks and must reliably demonstrate their capacity to correctly interpret what is described in the manual.



For safety reasons, only a qualified electrician who has received training and/or demonstrated skills and knowledge on the structure and operation of the unit may install the inverter.



The installation must be performed by qualified installers and/or licensed electricians in accordance with the existing regulations in the country of installation.



The employment of a person who is NOT qualified, is drunk, or on narcotics, is strictly forbidden.



The customer has civil liability for the qualification and mental or physical state of the professional figures who interact with the equipment. They must always use the personal protective equipment required by the laws of the country of destination and whatever is provided by their employer.

Symbols ad signs

In the manual and/or in some cases on the equipment, the danger or hazard zones are indicated with signs, labels, symbols or icons.

Table: Symbols

i		This points out that it is mandatory to consult the manual or original document, which must be available for future use and must not be damaged in any way.
		Generic hazard - Important safety information. This points out operations or situations in which staff must be very careful.
		Hazardous voltage - This points out operations or situations in which staff must be very careful due to hazardous voltage.
		Hot parts - This points out a hazard due to the presence of heated areas or in any case areas that have hot parts (danger of burns).
		This points out that the examined area must not be entered or that the described operation must not be carried out.
		This points out that it is mandatory to carry out the described operations using the clothing and/or personal protective equipment provided by the employer.
		This indicates the degree of protection of the equipment according to IEC standard 70-1 (EN 60529 June 1997).
		Point of connection for grounding protection.
		This indicates the allowed temperature range
		This indicates the risk of electric shock. Time need to discharge stored energy: 5/10 minutes
		Respectively direct current and alternating current
		Isolating transformer present or not present
		Positive pole and negative pole of the input voltage (DC)
		This indicates the centre of gravity of the equipment.

Field of use, general conditions

ABB shall not be liable for any damages whatsoever that may result from incorrect or careless operations.



*You may not use the equipment for a use that does not conform to that provided for in the field of use. The equipment **MUST NOT** be used by inexperienced staff, or even experienced staff if carrying out operations on the equipment that fail to comply with the indications in this manual and enclosed documentation.*



Intended or allowed use

This equipment is a inverter designed for:
transforming a continuous electrical current (DC)
supplied by a photovoltaic generator (FV)
in an alternating electrical current (AC)
suitable for feeding into the public distribution grid.

Limits in field of use

The inverter can be used only with photovoltaic modules which have ground isolated input poles, unless they are accessories installed that enable earthing of the inputs. In this case you must install an insulating transformer on the AC side of the system.

Only a photovoltaic generator can be connected in the input of the inverter (do not connect batteries or other sources of power supply).

The inverter can be connected to the electricity grid only in countries for which it has been certified/approved.

The inverter cannot be connected to the DC side in parallel to other inverters to convert energy from a photovoltaic generator with a power greater than the nominal power of the single inverter.

The inverter may only be used in compliance with all its technical characteristics.

Improper or prohibited use



IT IS STRICTLY FORBIDDEN TO:

- *Install the equipment in environments subject to particular conditions of flammability or in adverse or disallowed environmental conditions, (temperature and humidity).*
- *Use the equipment with safety devices which are faulty or disabled.*
- *Use the equipment or parts of the equipment by linking it to other machines or equipment, unless expressly provided for.*
- *Modify operating parameters that are not accessible to the operator and/or parts of the equipment to vary its performance or change its isolation.*
- *Clean with corrosive products that could eat into parts of the equipment or generate electrostatic charges.*
- *Use or install the appliance or parts of it without having read and understood the contents of the user and maintenance manual.*
- *Heat or dry rags and clothing on the parts in temperature. In addition to being hazardous, doing so would compromise component ventilation and cooling.*



General conditions

A description of the characteristics of the equipment is given so as to identify its main components and specify the technical terminology used in the manual.

Technical terminology and the fast retrieval system for information, are supported by:

- Contents
- Reference number index

The Characteristics chapter contains information about the models, details of the equipment, characteristics and technical data, overall dimensions and identification of the equipment itself.



The customer/Installer takes full responsibility if, when reading this manual, the chronological order of its presentation established by the manufacturer is not observed. All information is provided considering occasional inclusion of that provided in previous chapters.



In certain cases, there may be a need to separately document software functionality or attach supplementary documentation to this manual intended for more qualified professionals.

Models and range of equipment

The specific models of three-phase inverters covered by this manual are divided into three groups according to their maximum output power: 5.8 kW, 7.5kW or 8.5 kW.

For inverters of equal output power the variant between the various models is the presence or lack thereof of the DC disconnect switch 



The choice of the inverter model must be made by a qualified technician who knows about the installation conditions, the devices that will be installed outside the inverter and possible integration with an existing system.



• TRIO-5.8-TL-OUTD MODELS

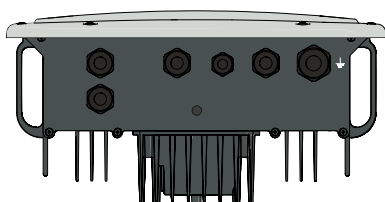

TRIO-5.8-TL-OUTD-400:

- Number of input channels: 1
- DC disconnect switch : No
- Input connectors: screw terminal block

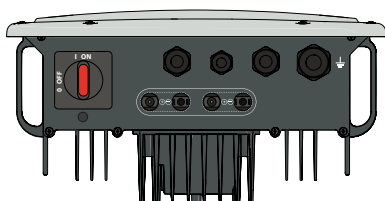

TRIO-5.8-TL-OUTD-S-400:

- Number of input channels: 1
- DC disconnect switch : Yes
- Input connectors: quick fit connectors (2 pairs)

• TRIO-7.5-TL-OUTD MODELS

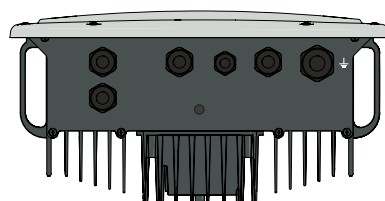

TRIO-7.5-TL-OUTD-400:

- Number of input channels: 2
- DC disconnect switch : No
- Input connectors: screw terminal block

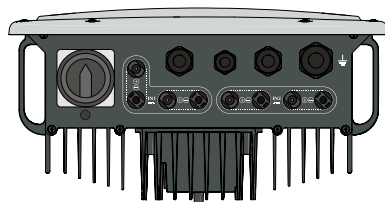

TRIO-7.5-TL-OUTD-S-400:

- Number of input channels: 2
- DC disconnect switch : Yes
- Input connectors: quick fit connectors (2 pairs for each channel)

• TRIO-8.5-TL-OUTD MODELS

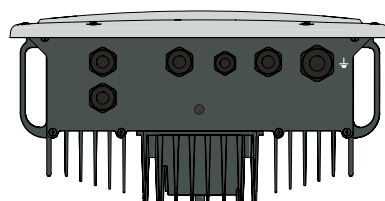

TRIO-8.5-TL-OUTD-400:

- Number of input channels: 2
- DC disconnect switch : No
- Input connectors: screw terminal block

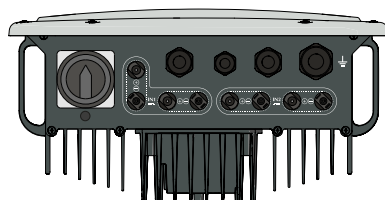

TRIO-8.5-TL-OUTD-S-400

- Number of input channels: 2
- DC disconnect switch : Yes
- Input connectors: quick fit connectors (2 pairs for each channel)

Identification of the equipment and the manufacturer

The technical data shown in this manual do not in any case replace those shown on the labels attached to the equipment.



The labels attached to the equipment must NOT be removed, damaged, dirtied, hidden, etc.

The approval label contains the following information:

1. Manufacturer
2. Model
3. Rating data
4. Certification marks



N.B. The labels must NOT be hidden with objects and extraneous parts (rags, boxes, equipment, etc.); they must be cleaned regularly and kept visible at all times.



1 **ABB** **4**

www.abb.com/solar **2** MODEL: **TRIO-5.8-TL-OUTD-S-400**

V_{dc} max	1000 V	V_{acr}	400 V 3Ø
V_{dc} MPP	200 - 950 V	f_r	50 Hz
V_{dc}, Full Power	320 - 800 V	P_{acr} (cos φ = 1)	5800 W @ 50 °C amb.
I_{dc} max	18.9 A	P_{acr} (cos φ = ±0.9)	5800 W @ 50 °C amb.
I_{sc} max	24 A	I_{sc} max	10 A

3

1 **ABB** **4**

www.abb.com/solar **2** MODEL: **TRIO-7.5-TL-OUTD-S-400**

V_{dc} max	1000 V	V_{acr}	400 V 3Ø
V_{dc} MPP	200 - 950 V	f_r	50 Hz
V_{dc}, Full Power	320 - 800 V	P_{acr} (cos φ = 1)	7500 W @ 50 °C amb.
I_{dc} max	2 x 15 A	P_{acr} (cos φ = ±0.9)	6750 W @ 50 °C amb.
I_{sc} max	2 x 20 A	I_{sc} max	12.5 A

3

1 **ABB** **4**





www.abb.com/solar **2** MODEL: **TRIO-8.5-TL-OUTD-S-400**

V_{dc} max	1000 V	V_{acr}	400 V 3Ø
V_{dc} MPP	200 - 950 V	f_r	50 Hz
V_{dc}, Full Power	320 - 800 V	P_{acr} (cos φ = 1)	8500 W (*)
I_{dc} max	2 x 15 A	P_{acr} (cos φ = ±0.9)	7650 W (*)
I_{sc} max	2 x 20 A	I_{sc} max	14.5 A

3

(*) Up to 50 °C with V_{dc} < 400 V

In addition to the label showing the specifications of the inverter, there are two part identification labels for the inverter and wiring box. These labels list the following information:

ABB TRIO-X-TL-OUTD-Y-400     	P/N: P/P/P/P/P/P/P/P/P/P SN: YYWWSSSSSS WK: WWYY WO: XXXXXXXX SO: SXXXXXXXX Q1	<ul style="list-style-type: none"> • Inverter model - X.X = Inverter power rating: - Y = Integrated disconnect switch • Inverter Part Number • Inverter Serial Number composed of: - YY = Year of manufacture - WW = Week of manufacture - SSSSSS = sequential number • Week/Year of manufacture
--	---	---



The officially required information is located on the approval label. The identification label is an accessory label which shows the information necessary for the identification and characterisation of the inverter by ABB.



N.B. The labels must NOT be hidden with objects and extraneous parts (rags, boxes, equipment, etc.); they must be cleaned regularly and kept visible at all times.

Inverter Composition

For each power size of the inverter ⑩ (5.8 / 7.5 / 8.5kW) 2 versions are available with different set-ups.

5.8kW Standard / -S Version

TRIO-5.8-TL-OUTD: Standard inverter version

TRIO-5.8-TL-OUTD-S: -S inverter version, as standard version but with DC disconnect switch ⑧

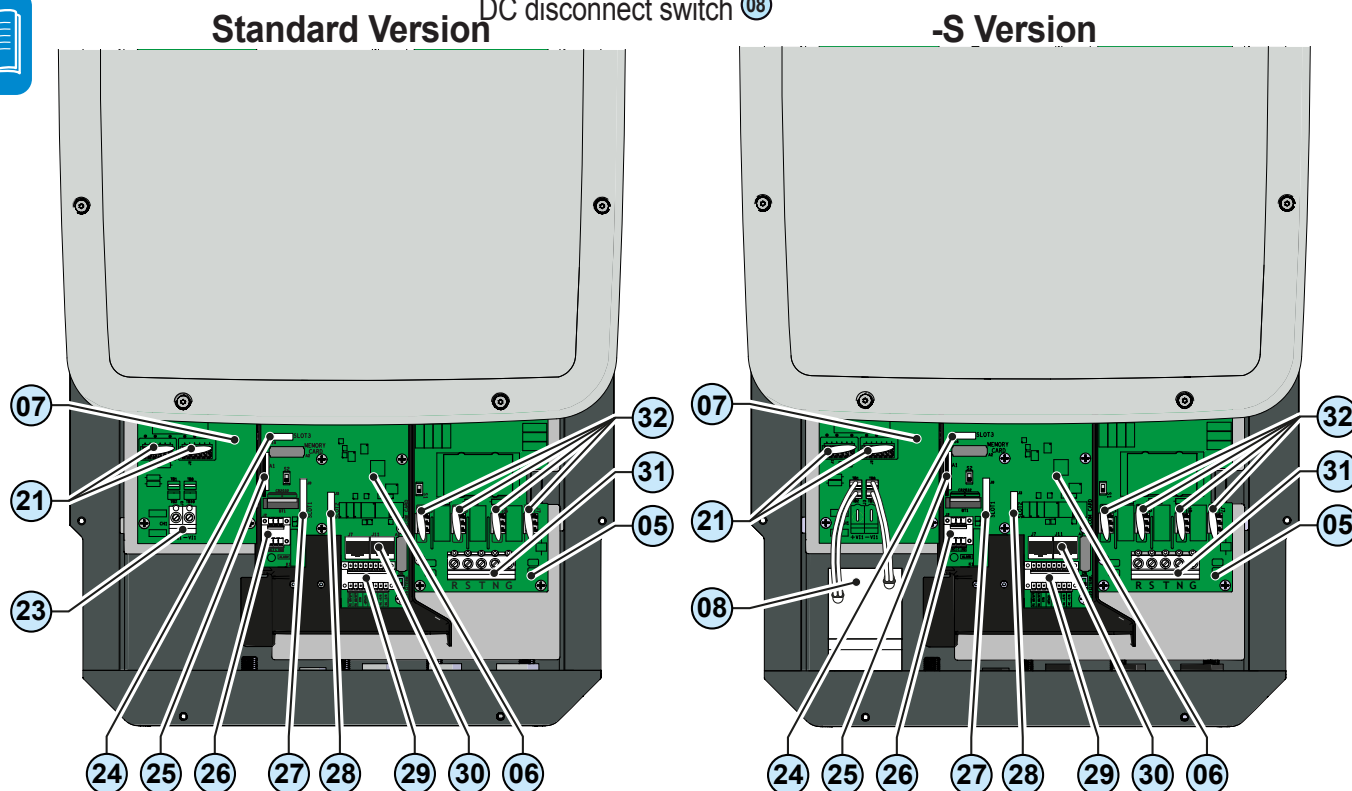

Table: TRIO-5.8kW main inverter components

Ref. Inverter	Ref. manual.	Description
-	⑤	AC output board
-	⑥	communication and control board
-	⑦	DC input board
-	⑧	DC disconnect switch
J1-J2	⑪	input varistors
J3	⑬	DC input terminal block
J14	⑭	SLOT 3 - Connector for WIFI modules installation (NOT ACTIVE)
A1	⑮	SD CARD housing
J2	⑯	Connection to the multi-function relay
J9	⑰	SLOT 1 - Connector for Radio module or Ethernet card installation
J3	⑱	SLOT 2 - Connector for PMU card installation
J4	⑲	Connection of the RS485 (PC) line, remote ON/OFF and Tachometer signal (WIND version)
J7-J11	⑳	RS485 (PC) line connection on RJ45 connector
J1	㉑	AC output terminal block
J7-J8-J9-J10	㉒	AC output varistors

7.5kW and 8.5kW Standard / -S Version

TRIO-7.5-TL-OUTD / TRIO-8.5-TL-OUTD: Standard inverter version

TRIO-7.5-TL-OUTD-S / TRIO-8.5-TL-OUTD-S: -S inverter version, as standard version but with DC disconnect switch ⁰⁸

Standard Version

-S Version

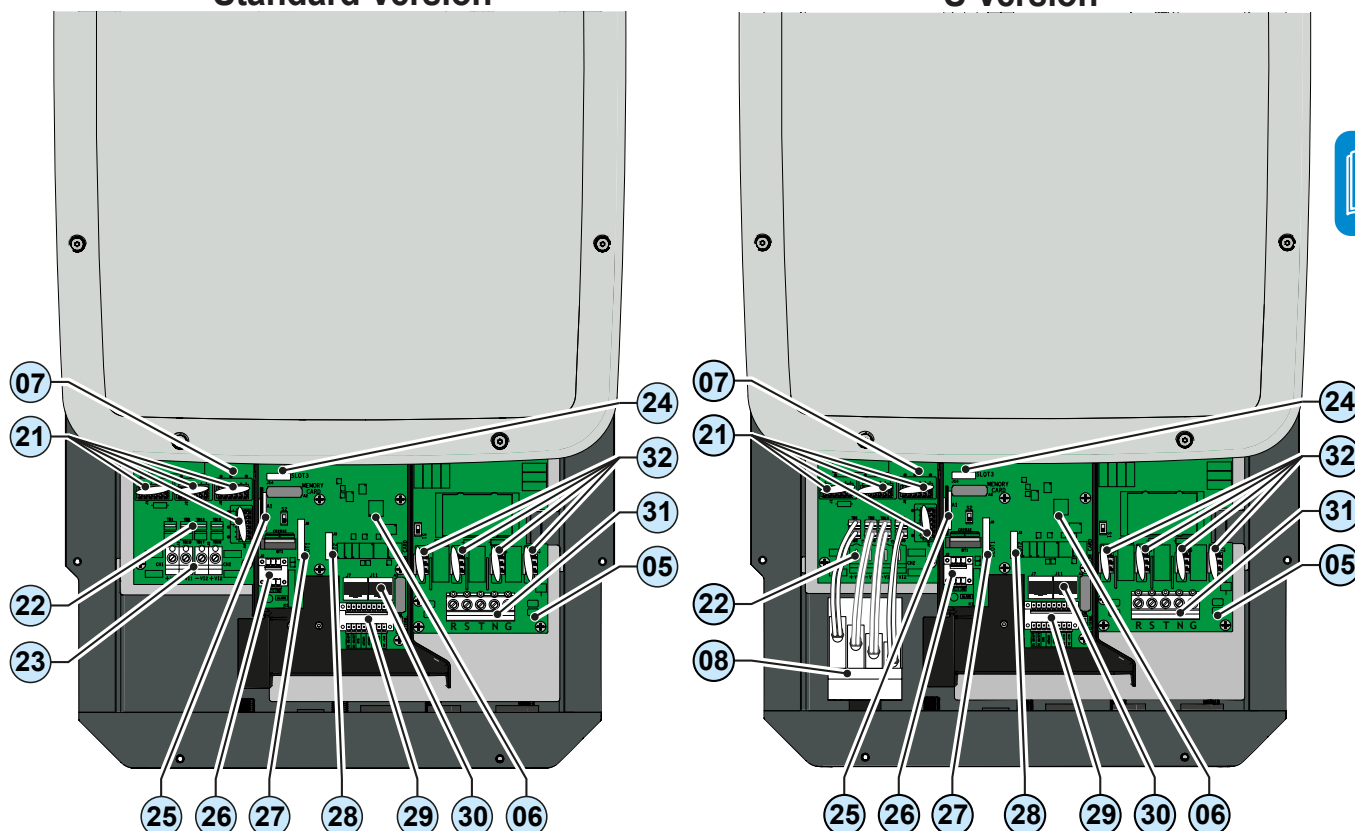

Table: TRIO-7.5 / 8.5kW main inverter components

Ref. Inverter	Ref. manual.	Description
-	05	AC output board
-	06	communication and control board
-	07	DC input board
-	08	DC disconnect switch
J1-J2-J8-J10	21	input varistors
TB1-TB8 TB15-TB19	22	Terminals for installation of jumpers for parallel input channels
J3-J5	23	DC input terminal block
J14	24	SLOT 3 - Connector for WIFI modules installation (NOT ACTIVE)
A1	25	SD CARD housing
J2	26	Connection to the multi-function relay
J9	27	SLOT 1 - Connector for radio module or Ethernet card installation
J3	28	SLOT 2 - Connector for PMU card installation
J4	29	Connection of the RS485 (PC) line, remote ON/OFF and Tachometer signal (WIND version)
J7-J11	30	Connection of the RS485 (PC) line on RJ45 connector
J1	31	AC output terminal block
J7-J8-J9-J10	32	AC output varistors

Accessory components (installable on the inverter)

For all inverter models accessory components are available that add specific functions to the inverter.



The accessories can be bought separately and installed directly by a qualified technician or by the installer.

The main characteristics of the accessory components are listed in the following paragraphs.



For information on the installation, compatibility and use, refer to the relevant accessory component documentation.

“Wifi Logger Card” accessory card

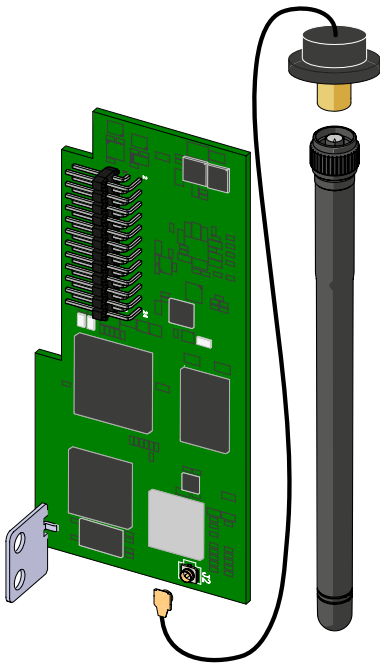

The Wifi Logger Card is a useful accessory for adding a wireless communication line (WiFi) for connecting the inverter with a WLAN local network permitting data transmission to the Aurora Vision Plant Viewer/ Aurora Vision® web portal for remote monitoring of the inverter/system via an internet or mobile browser App (Aurora Vision Plant Viewer^{for Mobile})

The code to use when ordering the accessory is: **VSN300 Wifi Logger Card**

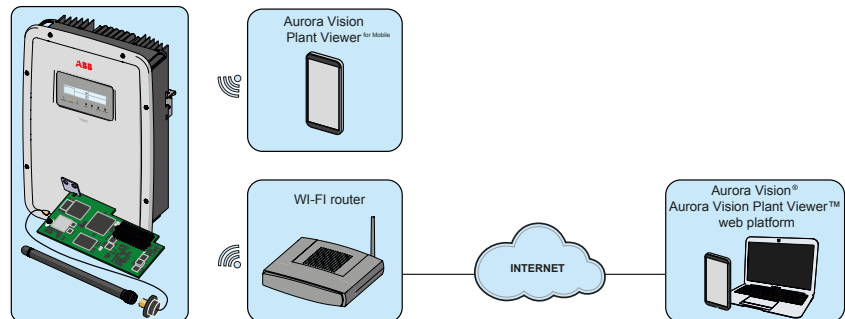

The accessory is made up of three components:

- Scheda WiFi
- Antenna
- Cable for connection between WiFi card and antenna

The Wifi Logger Card is installed in the inverter on the connector referred to as SLOT 1 27 on communication and control card 06.

The Wifi Logger Card is in turn connected with a wire ending in an adapter to be installed in place of one of the service cable glands 16 (on the outside of the inverter) with a connector on which to install the antenna.



Installation of the Wifi Logger Card makes it impossible to use the “ETHERNET expansion board” accessory as both use the same connector on the inverter

“ETHERNET Expansion Board” accessory board

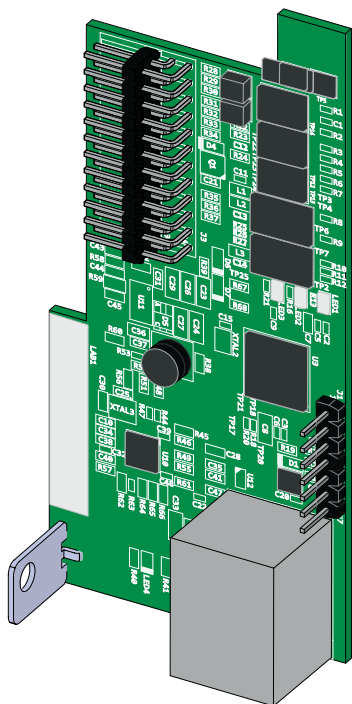

The Ethernet board is an accessory that allows you the possibility of connecting to the LAN for inverter monitoring; this may be done locally, with direct connection to the PC, by accessing the internal web server; or remotely, with internet connection to the through a router, to the portal "Aurora Vision Plant Viewer/Aurora Vision®".

The code to use when ordering the accessory is: **ETHERNET Expansion Board**

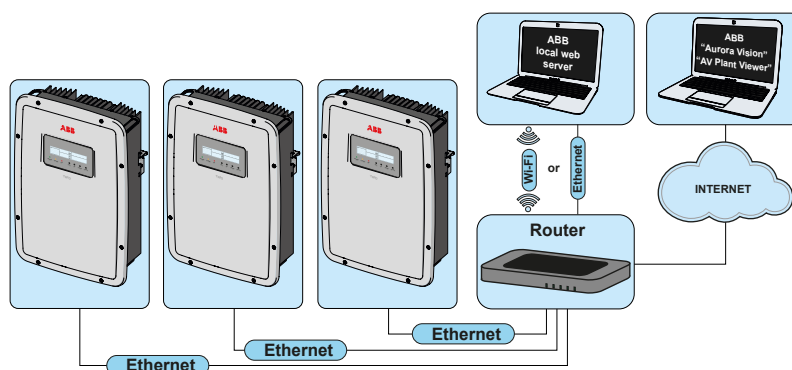

Install the Ethernet board to the interior of the inverter (to the connector named SLOT 1 ②7) which can be found on the communication and control board ①6).



Installing the "ETHERNET Expansion Board" makes it impossible to use the "VSN300 Wifi Logger Card" accessory because both use the same wiring connector on the inverter.

“PMU Expansion Board” accessory board

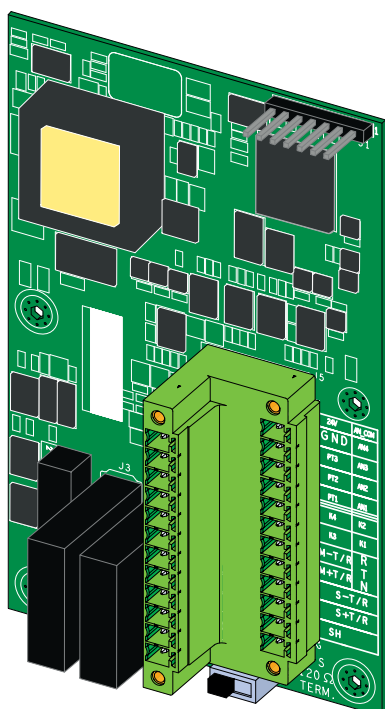

The PMU board is an accessory which allows you to add additional functionality to the inverter:

- PMU - Ability to remotely control reactive power and active power limitation by the grid or system manager.
- Analogue inputs - Allows you to connect up to 4 analogue sensors (AN1, AN2, AN3, AN4) and a PT100 or PT1000 sensor.
Inputs AN3 and AN4 can be used to control the PMU functions. In this case the number of environmental sensors which can be connected is 2 (AN1 and AN2)
- Analogue sensors power supply (16Vdc)
- RS485 serial line communication which can be used with a ModBus RTU communication protocol.

The code to use when ordering the accessory is: **PMU expansion board**

Install the PMU board to the interior of the inverter (to the connector named SLOT 2 ②8) which can be found on the communication and control board ①6).

Characteristics and technical data

Table: Technical Data TRIO-5.8-TL-OUTD TRIO-7.5-TL-OUTD TRIO-8.5-TL-OUTD

Input			
Absolute Maximum Input Voltage ($V_{max,abs}$)		1000 V	
Rated Input Voltage (V_{dcr})		620 V	
Input start-up voltage (V_{start})		350 V (adj. 200...500 V)	
Input operating interval ($V_{dcrmin}...V_{dcrmax}$)		0.7 x V_{start} ...950 V	
Input Nominal Power (P_{dcr})	5950 Wp	7650 Wp	8700 W
Number of Independent MPPT	1	2	2
Maximum input power for Each MPPT ($P_{MPPT-max}$)	6050 W		
	Derating from MAX to Zero [800V ≤ V_{MPPT} ≤ 950V]	4800 W	4800 W
DC Voltage MPPT Interval ($V_{MPPTmin}...V_{MPPTmax}$) to P_{acr}	320...800 V	-	-
Input voltage interval ($V_{MPPTmin} ... V_{MPPTmax}$) to P_{acr} (config. MPPT parallel)	-	320...800 V	320...800 V
Power limiting vs. Input voltage (parallel MPPT configuration)	-	Derating from MAX to Zero [800V ≤ V_{MPPT} ≤ 950V] 4800 W	Derating from MAX to Zero [800V ≤ V_{MPPT} ≤ 950V] 4800 W
DC Power limiting for each MPPT with Independent MPPT Configuration to P_{acr} , maximum unbalance example	-	[320V ≤ V_{MPPT} ≤ 800V] other channel: P_{dcr} -4800W [215V ≤ V_{MPPT} ≤ 800V]	[320V ≤ V_{MPPT} ≤ 800V] other channel: P_{dcr} -4800W [290V ≤ V_{MPPT} ≤ 800V]
Maximum DC Input Current (I_{dcrmax}) / for each MPPT ($I_{MPPTmax}$)	18.9 A	30 A / 15 A	30 A / 15 A
Maximum Return current (AC side vs DC side)		Negligible	
Number of DC Connection Pairs in Input for each MPPT		2 (Version -S)	
DC Input Connector type (components indicated or equivalents)		Connector PV Tool Free WM / MC4 (Screw terminal block in Standard version)	
Type of photovoltaic panels that can be connected at input according to IEC 61730		Class A	
Input protection			
Reverse Polarity Protection		Yes, from current limited source	
Input Overvoltage protection for each MPPT - Varistors		2 for each MPPT	
Maximum short-circuit current for each MPPT	24.0 A	20.0 A	20.0 A
Insulation Check		Complying with the local standard	
Input-ground capacity that can be borne without leakage protection		2.0uF	
Characteristics of DC Disconnect Switch for each MPPT (Version with DC disconnect switch)	16A / 1000V	25A / 800V	
Output			
AC Connection to the grid		Three-phase, 3 or 4 wires + PE	
Nominal AC output voltage (V_{acr})		400 V	
Output voltage range ($V_{acmin}...V_{acmin}$)		320...480 V ⁽¹⁾	
Nominal AC Output Power ($P_{acr} @ \cos\phi=1$)	5800 W	7500 W	8500 W
Maximum apparent Output power (S_{max})	5800 VA	7500 VA	8500 VA
Maximum output current (I_{acmax})	10.0 A	12.5 A	14.5 A
Contribution to short-circuit current	12.0 A	14.5 A	16.5 A
Inrush current		Negligible	
Maximum fault current		<20Arms(100ms)	



Table: Technical Data TRIO-5.8-TL-OUTD TRIO-7.5-TL-OUTD TRIO-8.5-TL-OUTD			
Rated Output Frequency (fr)	50 Hz / 60 Hz		
Output Frequency Range (f _{min} ...f _{max})	47...53 Hz / 57...63 Hz ⁽²⁾		
Nominal Power Factor (Cosφ _{iacr})	> 0.995, adj. ± 0.9 with Pacr =5.22 kW, adj. ± 0.8 with max 5.8kVA	> 0.995, adj. ± 0.9 with Pacr =6.75 kW, adj. ± 0.8 with max 7.5kVA	> 0.995, adj. ± 0.9 with Pacr =7.65 kW, adj. ± 0.8 with max 8.5kVA
Total Current Harmonic Distortion	< 2%		
AC Connections Type	Screw terminal block max cross-section 10 mm ²		
Output protection			
Anti-islanding Protection	Complying with the local standard		
Maximum AC Overcurrent protection	10.5 A	12.0 A	15.0 A
Output overvoltage protection - Varistors	4, plus gas arrester		
Operating performance			
Maximum Efficiency (η _{max})	98.0%		
Weighted Efficiency (EURO/CEC)	97.4% / -	97.5% / -	97.5% / -
Power Supply Threshold	32 W	36 W	36 W
Stand-by Consumption	< 15 W		
Night-time consumption	<5W ⁽³⁾		
Night-time Consumption (Reactive Power)	55 VAR		
Inverter Switching Frequency	15.8 kHz		
Communication			
Wired Local Monitoring (opt.)	Ethernet board with webserver (opt.), PVI-USB-RS232_485 (opt.)		
Remote Monitoring (opt.)	Ethernet board (opt.), VSN300 Wifi Logger Card (Opt.), PVI-AEC-EVO (Opt.), VSN 700 Data Logger (Opt.)		
Wireless Local Monitoring (opt.)	VSN300 Wifi Logger Card (opt.)		
User Interface	Graphic Display		
Environmental			
Ambient temperature	-25...+60°C /-13...140°F with derating above 50°C/122°F		
Storage temperature	-40...80°C (-40...+176°F)		
Relative Humidity	0...100% condensing		
Noise Emission	< 45 db(A) @ 1 m		
Maximum operating altitude	2000 m / 6560 ft		
External environment pollution rating	3		
Environmental class	Outdoor		
Physical			
Environmental Protection Rating	IP 65		
Cooling System	Natural		
Overvoltage rating as per IEC 62109-1	II (DC input) III (AC output)		
Dimensions (H x W x D)	641mm x 429mm x 220mm / 25.2" x 16.9" x 8.7" 855mm x 429mm x 237mm / 33.7" x 16.9" x 9.3" with cover open		
Weight	25.0 kg / 55.1 lb	28.0 kg / 61.7 lb	28.0 kg / 61.7 lb
Assembly System	Wall bracket		
Safety			
Safety class	I		
Insulation level	Without transformer (TL)		
Marking	CE		
Safety and EMC Standards	EN62109-1, EN62109-2, AS/NZS3100, AS/NZS 60950, EN61000-6-2, EN61000-6-3, EN61000-3-2, EN61000-3-3		
Grid Standard	CEI 0-21, CEI 0-16, VDE 0126-1-1, VDE-AR-N 4105, G83/1, C10/11, EN 50438 (not for all national variants), RD1699, RD 1565, ABNT NBR 16149		

1. The output voltage range may vary according to the grid standard of the country of installation
 2. The output frequency range may vary according to the grid standard of the country of installation
 3. <2W in Stand-by mode
- Note. Features not specifically mentioned in this data sheet are not included in the product

Tightening torques

To maintain the IP65 protection of the system and for optimal installation, the following tightening torques must be used:

AC cable gland ⑮ M32	8.0 Nm
Service cable glands ⑯ M25	7.5 Nm
Service cable glands ⑯ M20	7.0 Nm
DC cable glands ⑱ M25 (only standard versions)	7.5 Nm
Front cover ④	2.4 Nm
Input terminal block ⑳ - 16 mm ² Max (standard versions)	1.5 Nm
AC output terminal block ㉑ - 10 mm ² Max	1.5 Nm
Signal terminal block ㉒ - 1.5 mm ² Max	0.25 Nm
MC4 or Weidmuller quick fit connectors	2.5 Nm

Overall dimensions

The overall dimensions are expressed in millimetres and inches and include the wall installation bracket

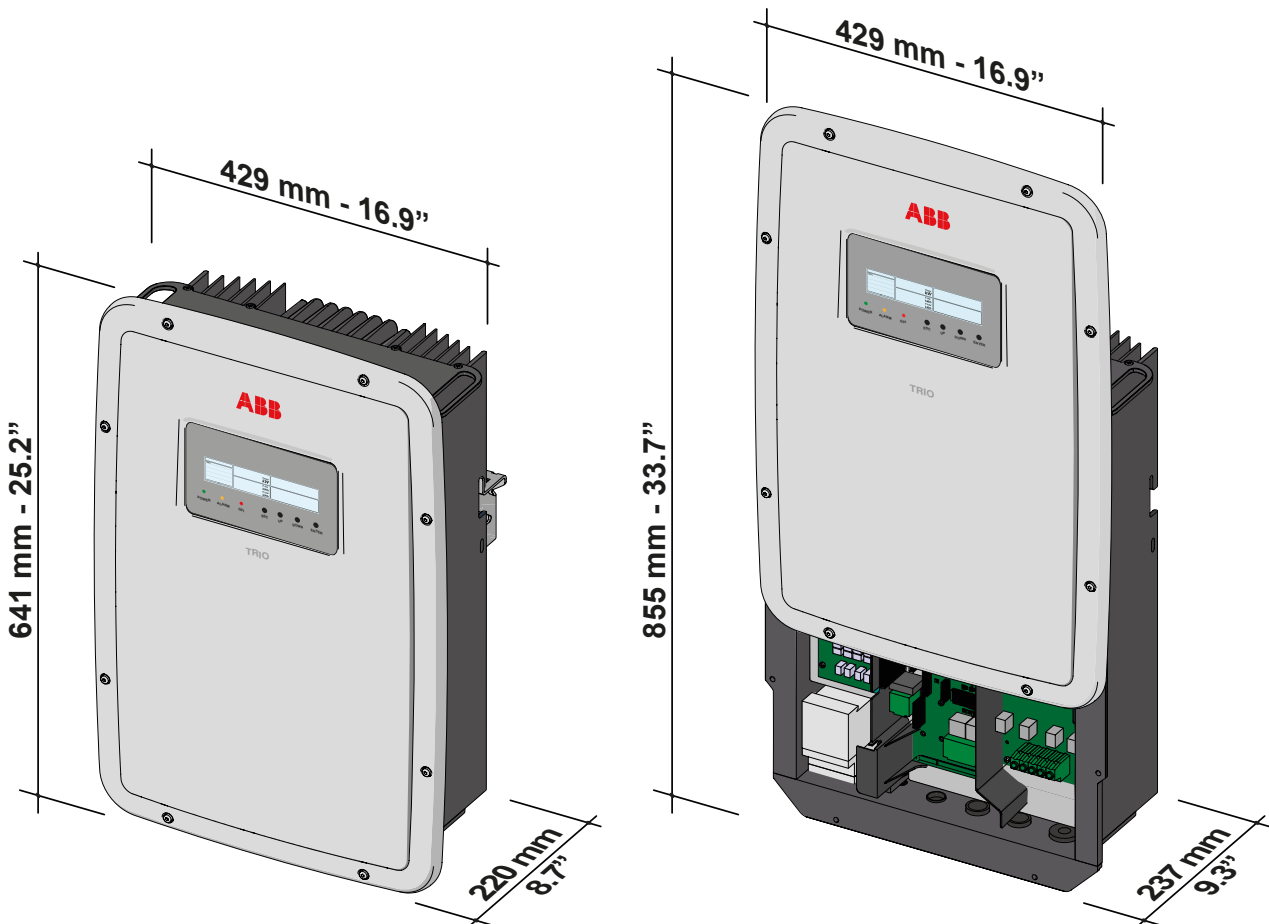

Bracket dimensions

The wall mounting bracket dimensions are expressed in mm and inches

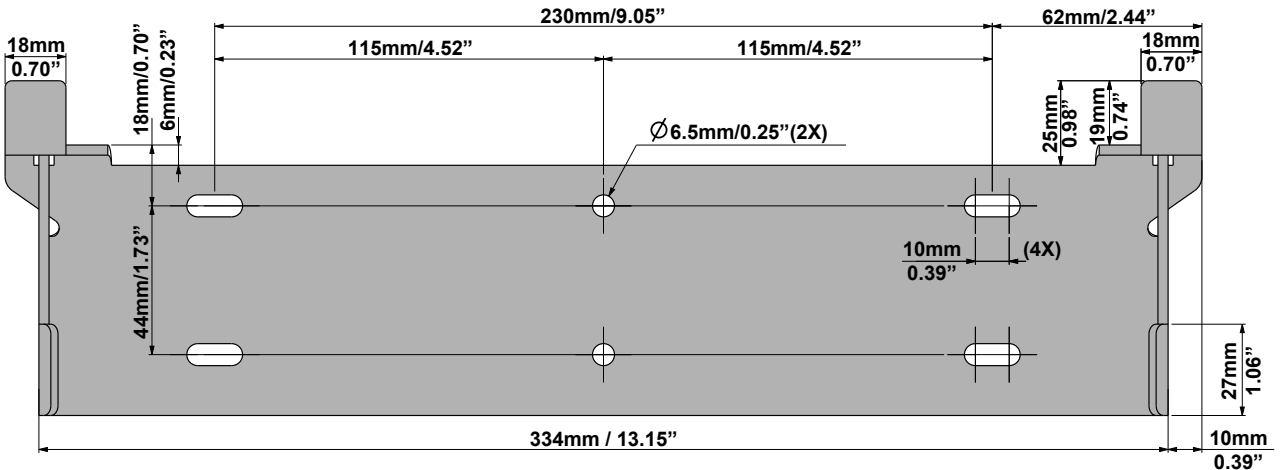
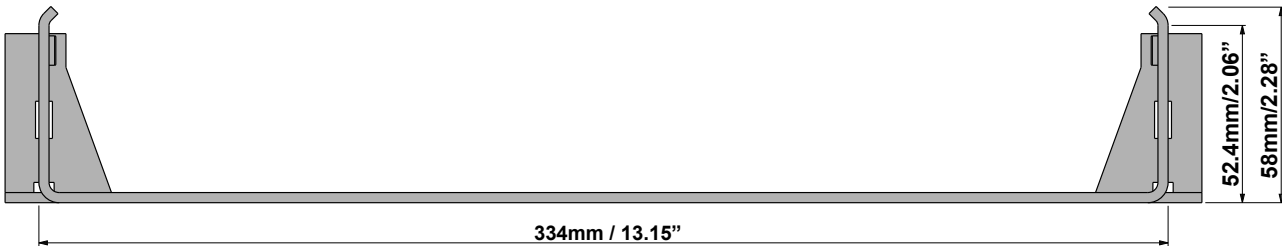
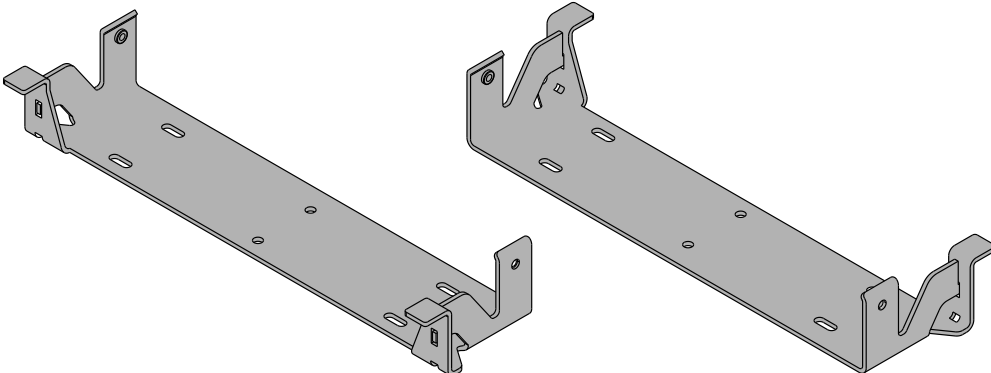

Efficiency curves

The equipment was designed in consideration of current energy conservation standards, to avoid waste and unnecessary leakage.

Graphs of the efficiency curves of all models of inverter described in this manual are shown below.

The efficiency curves are linked to technical parameters that are continually being developed and improved and should therefore be considered approximate.



TRIO-5.8-TL-OUTD TRIO-5.8-TL-OUTD-S

Pout% (320Vdc)	Eff. (320Vdc)
20	94.7
30	95.8
50	96.5
75	96.6
100	96.5
Pout% (620Vdc)	Eff. (620Vdc)
20	97.0
30	97.5
50	98.0
75	98.0
100	97.7
Pout% (800Vdc)	Eff. (800Vdc)
20	96.0
30	96.9
50	97.5
75	97.7
100	97.6

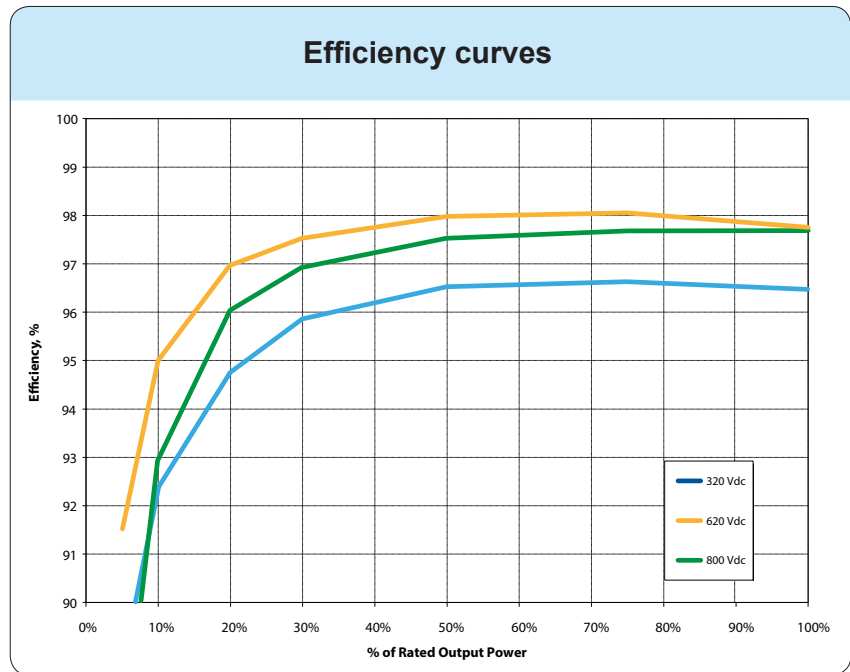

TRIO-7.5-TL-OUTD TRIO-7.5-TL-OUTD-S

Pout% (320Vdc)	Eff. (320Vdc)
20	94.7
30	95.7
50	96.5
75	96.7
100	96.6
Pout% (620Vdc)	Eff. (620Vdc)
20	96.9
30	97.5
50	98.0
75	98.0
100	97.5
Pout% (800Vdc)	Eff. (800Vdc)
20	95.2
30	96.4
50	97.2
75	97.5
100	97.5

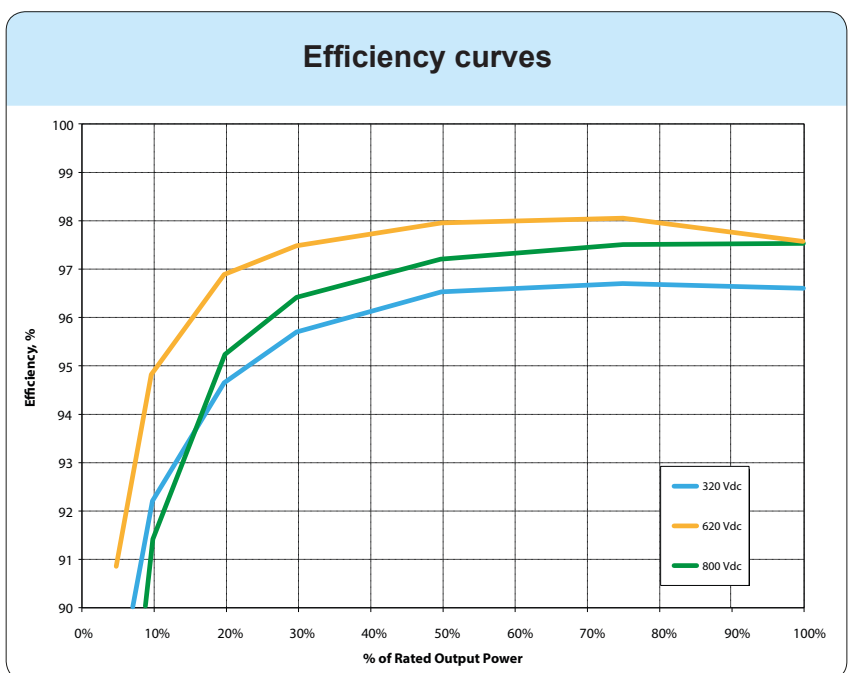

TRIO-8.5-TL-OUTD
TRIO-8.5-TL-OUTD-S

Pout% (320Vdc)	Eff. (320Vdc)
20	95.1
30	95.9
50	96.6
75	96.7
100	96.5
Pout% (620Vdc)	Eff. (620Vdc)
20	97.1
30	97.7
50	98.0
75	98.0
100	97.7
Pout% (800Vdc)	Eff. (800Vdc)
20	95.7
30	96.7
50	97.3
75	97.5
100	97.5

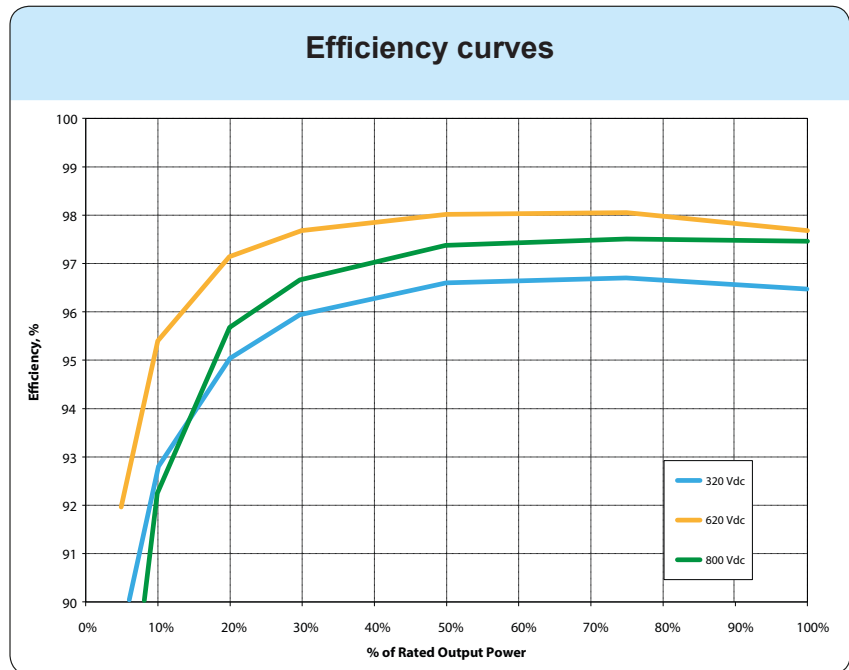

Power derating

In order to allow inverter operation in safe thermal and electrical conditions, the unit automatically reduces the value of the power fed into the grid.

Power limiting may occur due to:

- Adverse environmental conditions (thermal derating)
- Percentage of output power (value set by the user)
- Grid voltage over frequency (mode set by user)
- Grid over voltage $U > 10\text{min Der.}$ (enabling carried out by user)
- Anti-islanding
- Grid under voltage
- Input voltage values too high.
- Input current values too high.

Power derating due to environmental conditions

The power reduction value and the inverter temperature at which it occurs depend on the ambient temperature and on many operating parameters. Example: input voltage, grid voltage and power available from the photovoltaic field.

The inverter can therefore reduce the power during certain periods of the day according to the value of these parameters.

In any case, the inverter guarantees the maximum output power even at high temperatures, provided the sun is not shining directly on it.



TRIO-5.8-TL-OUTD
 TRIO-5.8-TL-OUTD-S
 TRIO-7.5-TL-OUTD
 TRIO-7.5-TL-OUTD-S
 TRIO-8.5-TL-OUTD
 TRIO-8.5-TL-OUTD-S

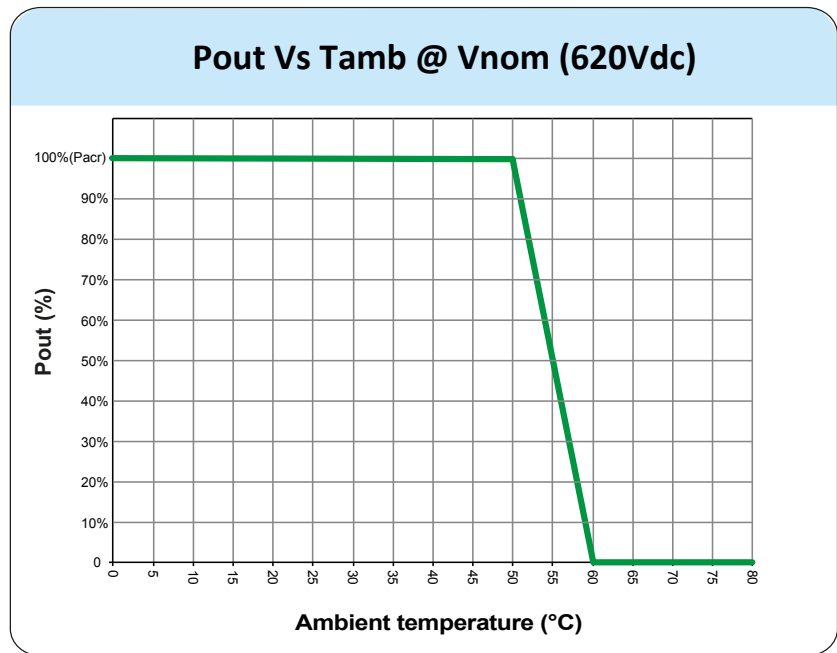

Power reduction due to the input voltage

The graphs show the automatic reduction of supplied power when input voltage values are too high or too low.

TRIO-5.8-TL-OUTD
 TRIO-5.8-TL-OUTD-S
 TRIO-7.5-TL-OUTD
 TRIO-7.5-TL-OUTD-S
 TRIO-8.5-TL-OUTD
 TRIO-8.5-TL-OUTD-S

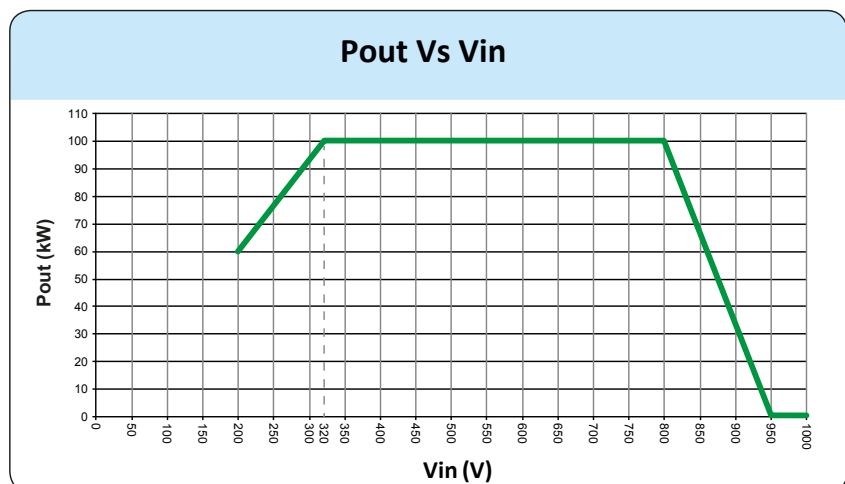

Characteristics of a photovoltaic generator

A PV generator consists of an assembly of photovoltaic panels that transform solar radiation into DC electrical energy and can be made up of:

Strings: X number of PV panels connected in series

Array: group of X strings connected in parallel

Strings and Arrays

In order to considerably reduce the cost of installing a photovoltaic system, mainly associated with the problem of wiring on the DC side of the inverter and subsequent distribution on the AC side, the string technology has been developed. A photovoltaic panel consists of many photovoltaic cells mounted on the same support.

- A string consists of a certain number of panels connected in series.
- An array consists of two or more strings connected in parallel.

Large photovoltaic systems can be made up of several arrays, connected to one or more inverters.

By maximizing the number of panels inserted into each string, it is possible to reduce the cost and complexity of the connection system of the photovoltaic system.

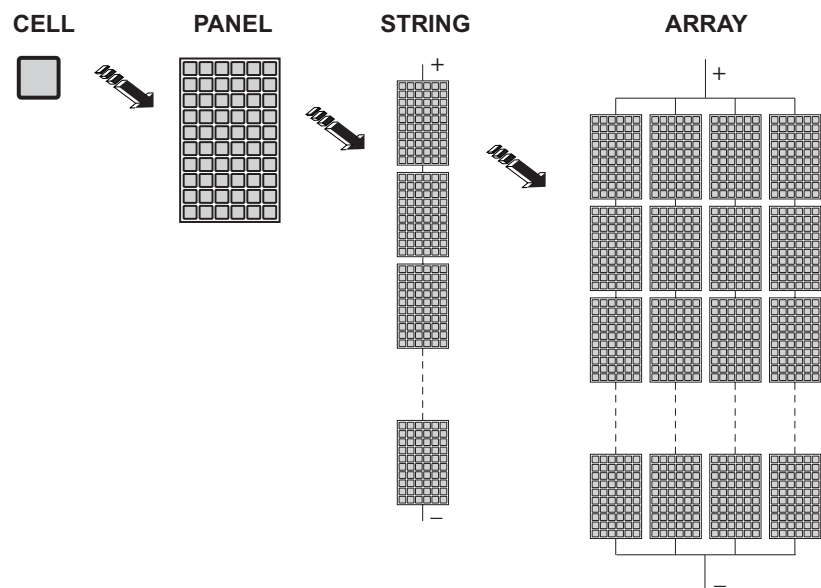

The current of each array must fall within the limits of the inverter.



To work, the inverter must be connected to the national electricity grid since its operation can be equated to a current generator that supplies power in parallel with the grid voltage. That is why inverters cannot support the grid voltage (islanding).

Description of the equipment

This equipment is an inverter that converts direct electric current from a photovoltaic generator into alternating electric current and feeds it into the national grid.

Photovoltaic panels transform energy from the sun into direct current (DC) electrical energy (through a photovoltaic field, also called photovoltaic (PV) generator; in order to use it it is necessary to transform the type of alternating current into "AC". This conversion, known as DC to AC inversion, is made efficiently without using rotating parts and only through static electronic devices.

In order to allow inverter operation in safe thermal and electrical conditions, in the event of adverse environmental conditions or unsuitable input voltage values, the unit automatically reduces the value of the power fed into the grid.

This way the solar energy system compensates for the energy drawn from the utilities connected to the grid to which it is linked.

The solar energy system therefore powers all connected electrical devices, from lighting to household appliances, etc.

When the photovoltaic system is not supplying sufficient power, the power needed to ensure normal operation of the connected electrical devices is drawn from the national grid. If, on the other hand, excess power is produced, this is fed directly into the grid, so becoming available to other consumers.

In accordance with local and national regulations, the power produced can be sold to the grid or credited towards future consumption, so bringing about a saving of money.

Operating diagram

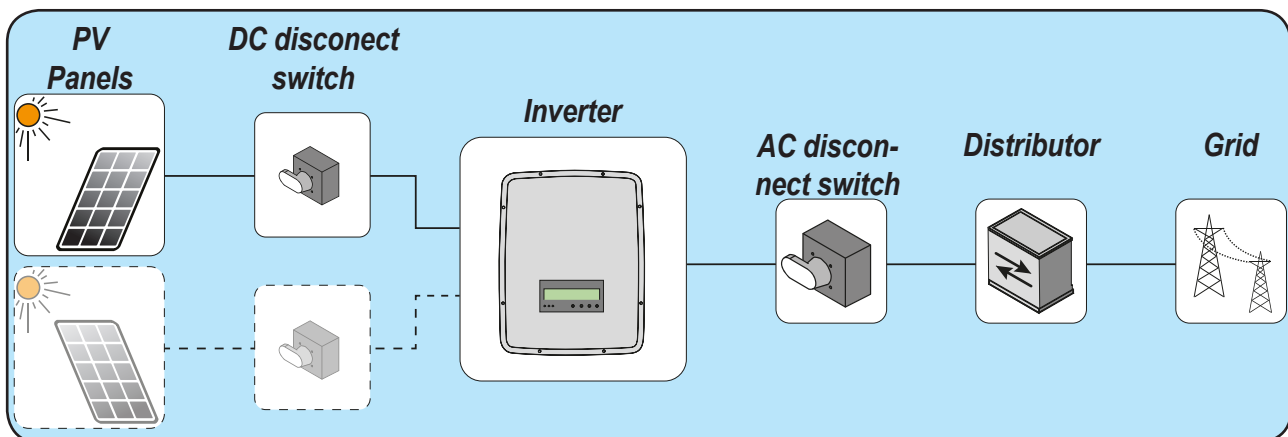

Connection of several inverters together

If the photovoltaic system exceeds the capacity of a single inverter, it is possible to make a multiple connection of inverters to the system, with each one connected to a suitable section of the photovoltaic field, on the DC side, and connected to the grid on the AC side.

Each inverter will work independently of the others and will supply the grid with the maximum power available from its section of photovoltaic panels.



Notes on the sizing of the system

Decisions about how to structure a photovoltaic system depend on a certain number of factors and considerations to make, such as for example, the type of panels, the availability of space, the future location of the system, energy production goals over the long term, etc.

A configuration program that can help to correctly size the photovoltaic system is available on the web site of ABB

Functionality and components of the equipment

Configurable relay

The inverter is equipped with a configurable switching relay, which can be used in different operating configurations that can be set in the dedicated menu. A typical example of application is the activation of the relay in the event of an alarm.

Remote switch-on/switch-off

This command can be used to turn off/turn on the inverter via an external (remote) command.

This functionality must be enabled in the menu and when active, switching on the inverter, besides being dictated by the presence of normal parameters which allow the inverter to be connected to the grid, also depends on the external control for switching on/off.

Reactive power feed into the grid

The inverter is capable of producing reactive power, and then feeding it into the grid through this connection, by setting the phase factor. Managing the input can be controlled directly by the grid company via a dedicated RS485 serial interface or set by the display or through the configuration software, Aurora Manager LITE.

Power feeding modes vary according to the country of installation and the grid companies. For detailed information on the parameters and characteristics of this function, contact **ABB** directly.

Limiting the active power fed into the grid

The inverter, if enabled and set using the display or the Aurora Manager configuration software, can limit the amount of active power fed into the grid by the inverter to the desired value (expressed as a percentage).

Data transmission and control

The inverter or a network of several inverters, can also be monitored remotely via an advanced communication system based on a RS-485 serial interface. The range of optional ABB devices that can be connected to this communication line allow you to monitor the device locally or remotely through an internet connection.

Stand by Mode

This functionality allows the inverter to remain on and grid connected even with an input voltage of less than the minimum required for operation. It is particularly useful in conditions of low irradiation and with passing shadowed areas that would cause continuous connections and disconnections to the grid. Instead, with this functionality, the inverter starts to deliver power as soon as the input voltage exceeds the minimum for re-activation without having to repeat the grid connection sequence.

The time in which the inverter remains in this state can be set by accessing the Settings menu and activating the time for Input Undervoltage Protection (TprotUV). If within the set time the conditions to export grid power do not reoccur, the inverter disconnects from the grid and goes into SLEEP Mode.



SLEEP Mode

This mode, if enabled in the display menu, allows you to keep the inverter logic part in operation, even in the absence of voltage from the PV generator, and is particularly useful in case of installation of the accessory cards aboard the inverter because you can keep running and you can take advantage of features like, for example, monitoring of the system (Ethernet card) or reactive power management (PMU) overnight.

SD Card

The inverter is equipped with a slot for insertion of an SD Card memory. The maximum size of the SD Card is 4 GB. Its main functionality is allowing the inverter firmware to be updated in few and simple steps. The most up-to-date inverter firmware version is available from the website <https://registration.abbsolarinverters.com>



Topographic diagram of the equipment

The diagram summarises the internal structure of the inverter.

The main blocks are the DC-DC input converters (called "boosters") and the output inverter. The DC-DC converter and the output inverter both work at a high switching frequency, and so are small and relatively light. Each of the input converters is dedicated to a separate array, with independent maximum power point tracking (MPPT) control, with the exception of the TRIO-5.8-TL-OUTD model which features a single input channel.

This means that the two arrays may be installed with various positions or orientations. Each array is controlled by an MPPT control circuit.

The two trackers can be configured (where required) in parallel to handle power levels and/or current higher than those that a single tracker can handle.

This inverter version is of the type without transformer, that is without galvanic insulation between the input and the output. This allows ultimately an increase in conversion efficiency. The inverter is already equipped with all the protections necessary for safe operation and compliance with the norms, even without the insulating transformer.

The inverter is controlled by two independent DSPs (Digital Signal Processors) and a central microprocessor.

The connection to the power grid is thus kept under control by two independent computers, in full compliance with the electric field norms both for power supply to the systems as well as security.

The operating system carries out the task of communicating with its components in order to carry out data analysis.

In doing all this, we guarantee optimal operation of the whole complex and a high performance in all sunlight conditions and always ensuring full compliance with the relevant directives, standards and regulations.



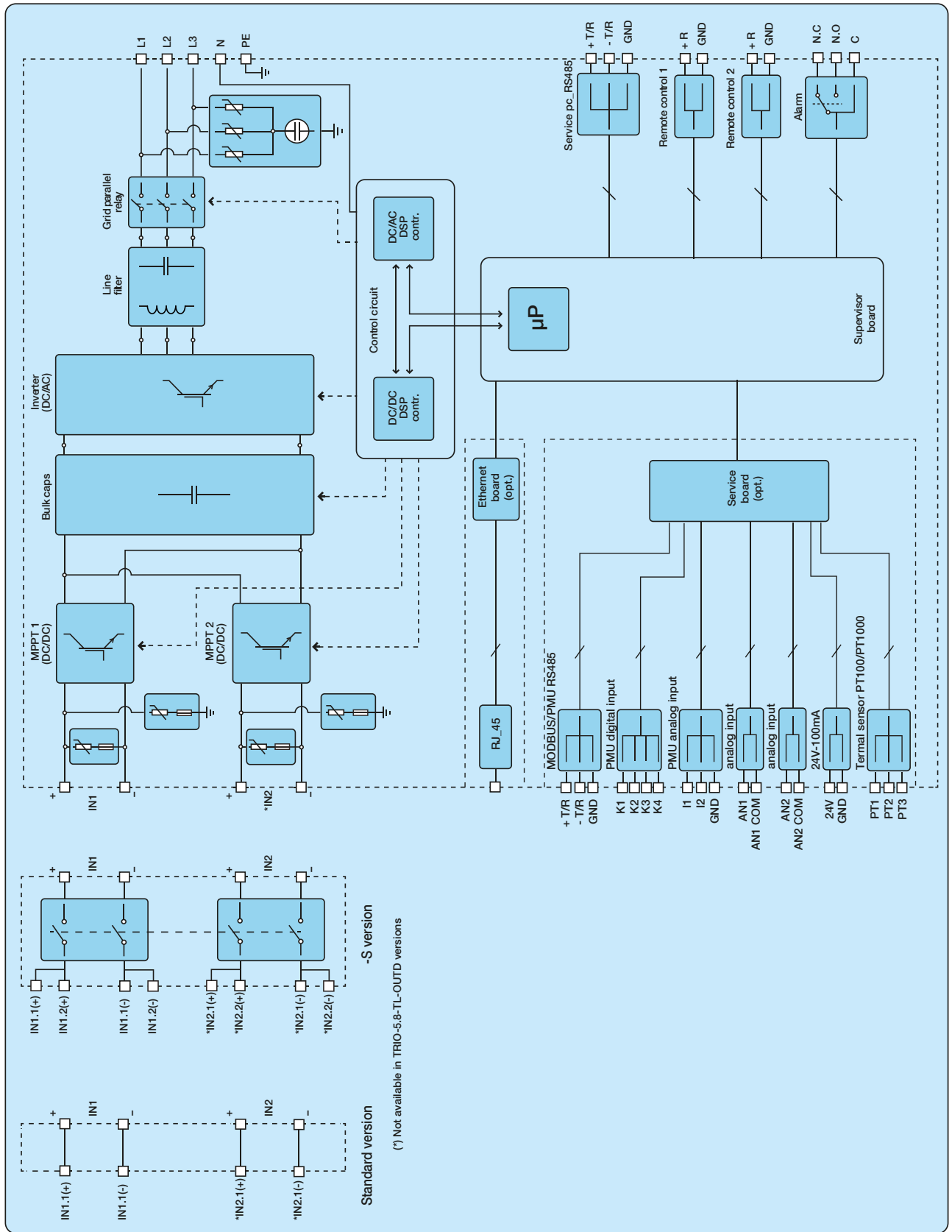

(*) Not available in TRIO-5.8-TL-OUTD versions



Safety devices

Anti-Islanding

In the event of a local grid outage by the electricity company, or when the equipment is switched off for maintenance operations, the inverter must be physically disconnected to ensure the protection of the people working on the grid, in accordance with the relevant national laws and regulations. To prevent possible islanding, the inverter is equipped with an automatic safety disconnection system called "Anti-Islanding".

Anti-islanding protection mechanisms are different depending on the grid standards, even if they all have the same purpose.

Ground fault of the photovoltaic panels

This inverter must be used with panels connected in "floating" mode, i.e. with no earth connections on the positive and negative terminals. An advanced ground fault protection circuit continuously monitors the ground connection and disconnects the inverter when a ground fault indicating the fault condition by means of the red "GFI" LED on the LED panel on the front side.

Other safety devices

The inverter is equipped with additional protective devices to ensure safe operation in any circumstance. These protections include:

- Constant monitoring of the grid voltage to ensure that voltage and frequency values remain within operating limits;
- Internal temperature control to automatically limit the power if necessary to prevent overheating of the unit (derating).

The numerous control systems determine a redundant structure to ensure absolutely safe operations.

Safety instructions and general information

The equipment has been manufactured in accordance with the strictest accident-prevention regulations and supplied with safety devices suitable for the protection of components and operators.



For obvious reasons, it is not possible to anticipate the great number of installations and environments in which the equipment will be installed; it is therefore necessary for the customer to appropriately inform the manufacturer about particular installation conditions.

ABB accepts no liability for failure to comply with the instructions for correct installation are cannot be held responsible for the systems upstream or downstream of the equipment it has supplied.



It is essential to provide operators with correct information. They must therefore read and comply with the technical information given in the manual and in the attached documentation.

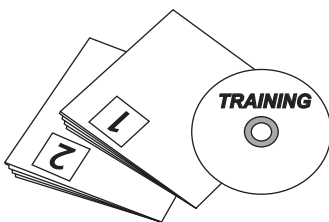

The instructions given in the manual do not replace the safety devices and technical data for installation and operation stuck on the product, and they certainly do not replace the safety regulations in force in the country of installation and common sense rules.

The manufacturer is willing to train staff, at its premises or on site, in accordance with conditions to be set out in the contract.



Do not use the equipment if you find any operating anomalies.

Avoid temporary repairs. All repairs should be carried out using only genuine spare parts, which must be installed in accordance with their intended use.

Liabilities arising from commercial components are delegated to the respective manufacturers.

Hazardous areas and operations

Environmental conditions and risks

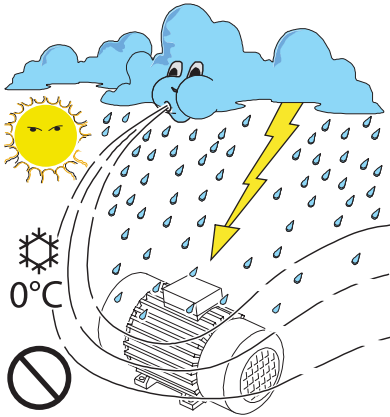

The equipment can be installed outdoors, but only in environmental conditions that do not prevent its regular operation. These conditions are reported on the technical data and on installation chapter.

ABB CANNOT be held responsible for disposal of the equipment: displays, cables, batteries, accumulators, etc., and therefore the customer must dispose of these substances, which are potentially harmful to the environment, in accordance with the regulations in force in the country of installation.

The same precautions should be adopted for dismantling the equipment.



The equipment is not equipped to operate in environments that have particular flammability or explosive conditions.

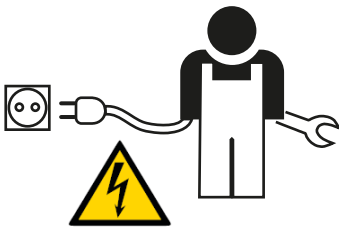

The customer and/or installer must appropriately train operators or anyone who may come near the equipment, and highlight, if necessary with notices or other means, the hazardous areas or operations at risk if required: magnetic fields, hazardous voltages, high temperatures, possibility of discharges, generic hazard, etc.

Signs and Labels



The labels attached to the equipment must absolutely **NOT** be removed, damaged, dirtied, hidden, etc.

The labels must be cleaned regularly and kept visible at all times, that is, they must **NOT** be hidden with objects and extraneous parts (rags, boxes, equipment, etc.)

The technical data shown in this manual do not in any case replace those shown on the labels attached to the equipment.

Thermal hazard

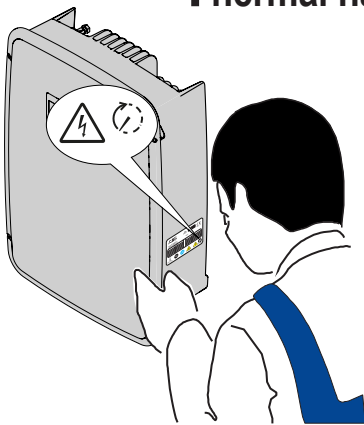

WARNING: removal of guards or covers is allowed only after the voltage has been removed; ; this is to let components cool down and allow any electrostatic charges and parasitic voltages to be discharged.

When the equipment has just been switched, it may have hot parts, as a result of overheating of the surfaces at temperature (e.g.: transformers, accumulators, coils, etc.) so be careful where you touch.

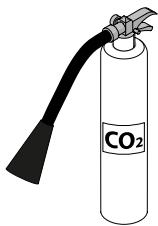

In the event of fire, use CO₂ extinguishers and use auto extraction systems to fight fire in closed environments.



Clothing and protective devices for staff

ABB has eliminated sharp edges and corners, but in some cases it is not possible to do anything, and we therefore advise wearing the clothing and personal protective devices provided by the employer.



Staff must not wear clothes or accessories that can start fires or generate electrostatic charges or, in gener, clothing that can impede personal safety.



All operations on the equipment should be performed with suitably insulated clothes and instruments.

E.g.: Insulated gloves (class 0, category RC)

Maintenance operations must be carried out with the equipment disconnected from the grid and from the photovoltaic generator.

Staff must NOT go near the equipment with bare feet or wet hands.

The maintenance technician must in any case make sure no one else can switch on or operate the equipment during the maintenance operations, and must report any anomaly or damage due to wear or ageing so that the correct safety conditions can be restored.

The installer or maintenance technician must always pay attention to the work environment, so that it is well lit and has sufficient spaces to ensure they have an escape route.



In the installation, consider or make sure the **noise emitted based on the environment** is not such that it exceeds thresholds allowed by law (less than 80 dBA).

Residual risks



Despite the warnings and safety systems, there are still some residual risks that cannot be eliminated.

These risks are listed in the following table with some suggestions to prevent them.

Table of residual risks

RISK ANALYSIS AND DESCRIPTION	SUGGESTED REMEDY
Noise pollution due to installation in unsuitable environments or where staff work permanently.	Reassess the environment or the place of installation.
Suitable local ventilation that does not cause overheating of the equipment and is sufficient not to create discomfort to people in the room.	Restore suitable ambient conditions and air the room.
External weather conditions, such as water seepage, low temperatures, high humidity, etc.	Maintain ambient conditions suitable for the system.
Overheating of surfaces at temperature (transformers, accumulators, coils, etc.) can cause burns. Also be careful not to block the cooling slits or systems of the equipment.	Use suitable protective equipment or wait for the parts to cool down before switching on the equipment.
Inadequate cleaning: compromises cooling and does not allow the safety labels to be read.	Clean the equipment, labels and work environment adequately.
Accumulation of electrostatic energy can generate hazardous discharges.	Ensure the devices have discharged their energy before working on them.
Inadequate training of staff.	Ask for a supplementary course.
During installation, temporarily mounting the equipment or its components may be risky.	Be careful about and disallow access to the installation area.
Accidental disconnections of the quick-fit connectors with the equipment in operation, or wrong connections, may generate electric arcs	Be careful about and disallow access to the installation area.

General conditions

Some recommendation apply only to large size product or multiple small size packings.

Transport and handling



Transport of the equipment, especially by road, must be carried out with by suitable ways and means for protecting the components (in particular, the electronic components) from violent shocks, humidity, vibration, etc. **During handling, do not make any sudden or fast movements that can create dangerous swinging.**

Lifting



ABB usually stores and protects individual components by suitable means to make their transport and subsequent handling easier, but as a rule it is necessary to turn to the experience of specialized staff in change of loading and unloading the components.

Where indicated and/or where there is a provision, eyebolts or handles, which can be used as anchorage points, are inserted and/or can be inserted.

The ropes and means used for lifting must be suitable for bearing the weight of the equipment.

Do not lift several units or or parts of the equipment at the same time, unless otherwise indicated.

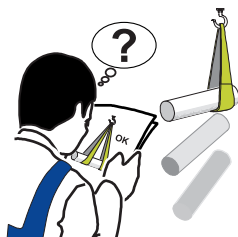
Unpacking and checking

We remind you that the packaging elements (cardboard, cellophane, staples, adhesive tape, straps, etc.) may cause cuts and/or injuries if not handled with care. They should be removed by suitable means and not left in the hands of irresponsible people (e.g., children).







The components of the packaging must be disposed on in accordance with the regulations in force in the country of installation.

When you open the package, check that the equipment is undamaged and make sure all the components are present.

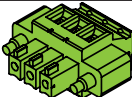
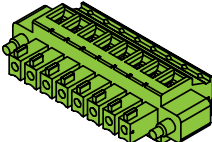
If you find any defects or damage, stop unpacking and consult the carrier, and also promptly inform the Service ABB.

List of components supplied

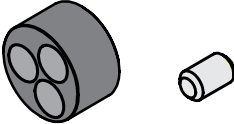
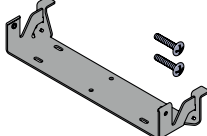
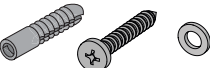
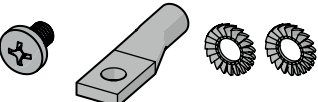
Supplied with the inverter are all the components required to correctly install and connect the inverter

Components available for all models		Qty
	Connector for connecting the configurable relay	2
	Connector for connecting the communication and control signals	2
	Male key TORX TX25	1
	Two-hole gasket for M25 signal cable glands and cap	2 + 2
	Two-hole gasket for M20 signal cable glands and cap	1 + 1
	Three-holed gasket for M25 DC cable glands + caps (use only for models without DC disconnect switch)	2 + 4
	Bracket for wall fastening + locking screws	1 + 2
	Plugs and screws for wall mounting	4 + 4
	Screw + cable lug + washers for installation of the second protective earthing cable	1 + 1 + 2
	Technical documentation	1

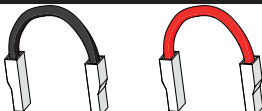
Additional components for 7.5/8.5kW models		Qty
	Jumpers for configuration of the parallel input channels	1 + 1

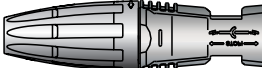
Additional components models with disconnect switch(-S)		Qty
	Quick fit connectors (female)	2(5.8 kW) 4(7.5/8.5 kW)
	Quick fit connectors (male)	2(5.8 kW) 4(7.5/8.5 kW)

Weight of the groups of device

Table: Weights	Weight (Kg/lb)	Lifting points (no.#)
INVERTER	TRIO-5.8: 25 kg / 55.1lb	4
	TRIO-7.5: 28 kg / 61.7lb	
	TRIO-8.5: 28 kg / 61.7lb	

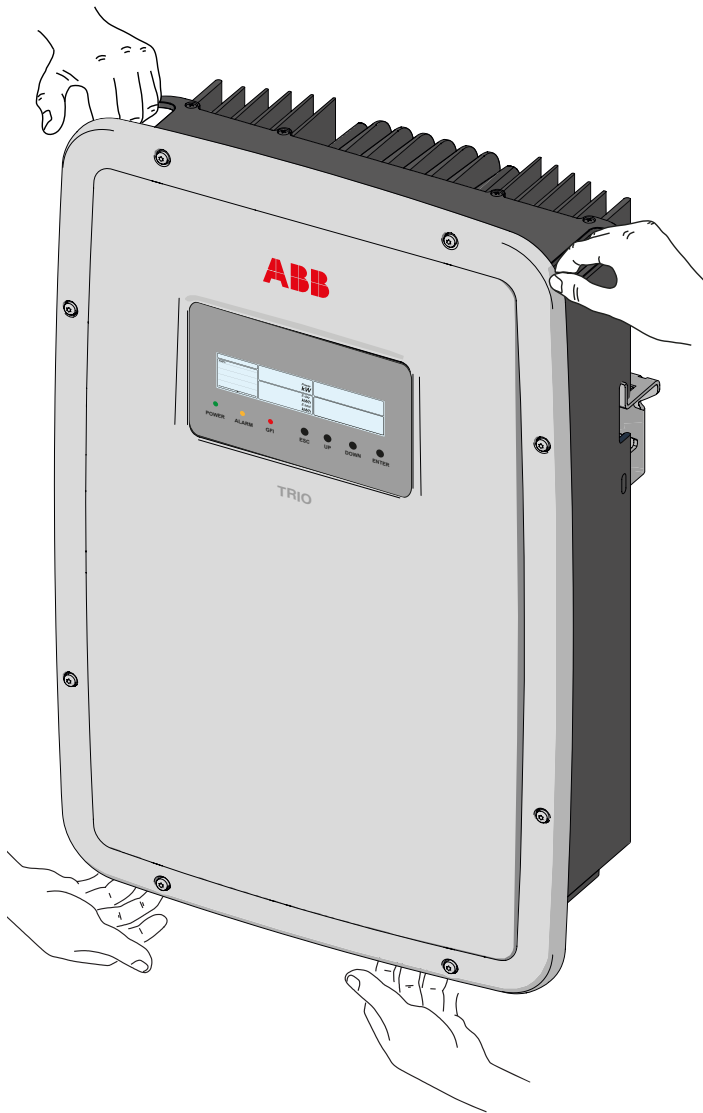

MAX 3

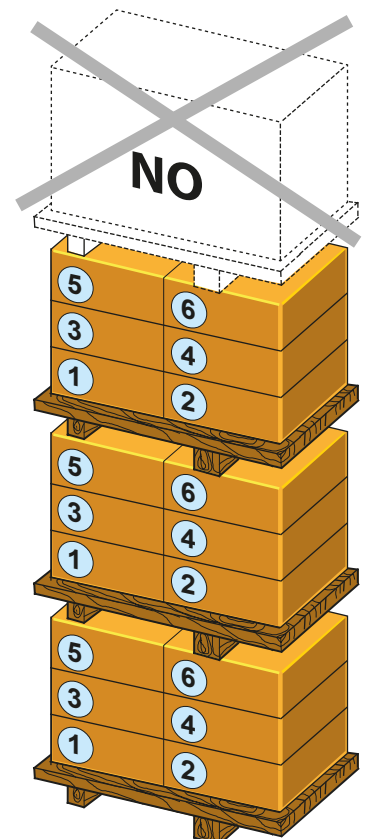
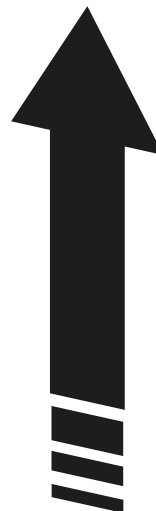

General conditions

Installation of the equipment is carried out based on the system and the place in which the equipment is installed; therefore, its performance depends on the correctness of the connections.

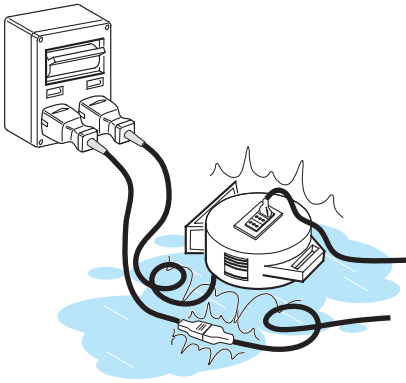

Staff authorised to carry out the installation must be specialised and experienced in this job; they must also have received suitable training on equipment of this type.

The operation must be carried out by specialised staff; it is in any case advisable to comply with what is written in this manual and adhere to the diagrams and attached documentation.



For Safety reason only a qualified electrician, who has received training and / or has demonstrated skills and knowledge in construction and in operation of this unit, can install this inverter.



The installation is done by qualified installers and/or licensed electrician according to the applicable local code regulations



The connection of an inverter energy system to an electrical installation connected to the electricity distribution network shall be approved by the appropriate electrical distributor.



The installation must be carried out with the equipment disconnected from the grid and from the photovoltaic generator.



When the photovoltaic panels are exposed to light, these supplies a direct current voltage to the inverter.

Environmental checks

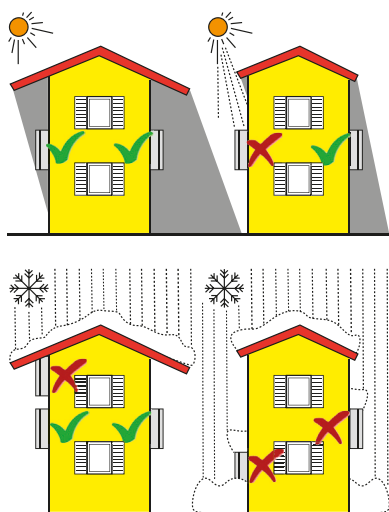

- Consult the technical data to check the environmental parameters to be observed (degree of protection, temperature, humidity, altitude, etc.)
- The installation to direct sunlight must be avoided because it may cause:
 - phenomena of power limitation by the inverter (with consequent reduction of energy production)
 - premature aging of electronic/electromechanical components
 - premature aging of mechanical components (gaskets) and user interface (display)
- Do not install in small closed rooms where air cannot circulate freely.
- To avoid overheating, always make sure the flow of air around the inverter is not blocked.
- Do not install in places where gases or flammable substances may be present.
- Do not install in rooms where people live or where the prolonged presence of people or animals is expected, because of the noise (about 45dB(A) at 1 m) that the inverter makes during operation.
- Avoid electromagnetic interference that can compromise the correct operation of electronic equipment, with consequent situations of danger.



The final installation of the inverter should not prevent access to any outside disconnection means.

Refer to the warranty conditions to evaluate the possible exclusions from warranty related to improper installation.

Installations above 2000 metres

On account of the rarefaction of the air (at high altitudes), particular conditions may occur that should be considered when choosing the place of installation:



- Less efficient cooling and therefore a greater likelihood of the device going into derating because of high internal temperatures.
- Reduction in the dielectric resistance of the air that, in the presence of high operating voltages (DC input), can create electric arcs (discharges) that can reach the point of damaging the inverter.

As the altitude increases, the failure rate of some electronic components increases exponentially because of cosmic radiation.



All installations at altitudes of over 2000 metres must be assessed case by case considering the aforesaid criticalities.

Installation position

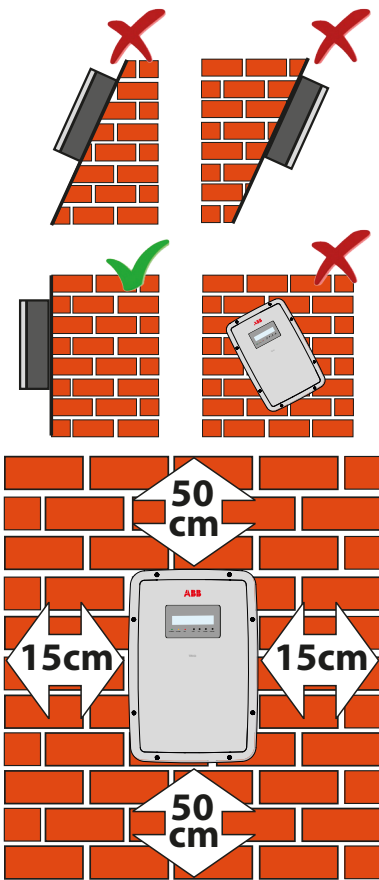

When choosing the place of installation, comply with the following conditions:

- Install on a wall or strong structure suitable for bearing the weight.
- Install in safe, easy to reach places.
- If possible, install at eye-level so that the display and status LEDs can be seen easily.
- Install at a height that considers the heaviness of the equipment. If this condition is not complied with, it can create problems in the event of servicing unless suitable means are provided to carry out the operation.
- Install vertically with a maximum inclination of $\pm 5^\circ$. If this condition is not complied with, the inverter could go into temperature derating because of the worsening of heat dissipation.

- To carry out maintenance of the hardware and software of the equipment, remove the covers on the front. Check that there are the correct safety distances for the installation that will allow the normal control and maintenance operations to be carried out.
- Comply with the indicated minimum distances.

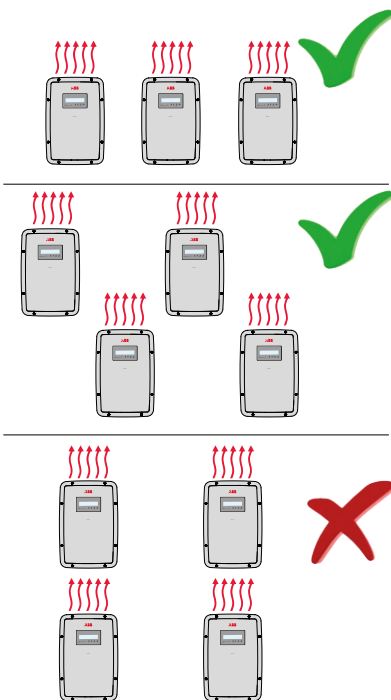

- For a multiple installation, position the inverters side by side.

- If the space available does not allow this arrangement, position the inverters in a staggered arrangement as shown in the figure so that heat dissipation is not affected by other inverters.

Wall mounting

During installation do not place the inverter ⑩ with the front cover ④ facing towards the ground.

- Position the bracket ⑬ so that it is perfectly level on the wall and use it as a boring template.
- Make the 4 holes necessary, using a drill with a 10 mm. diameter bit. The depth of the holes must be around 70 mm.
- Secure the bracket to the wall with the no. 4 10 mm wall plugs supplied with it.
- Attach the inverter by inserting the two tabs on the bracket ⑬ into the 2 holes on the inverter (figure A1 and A2).
- Secure the inverter to the bracket by screwing the lock screws ⑭ on both sides of the inverter (figure A3).
- Unscrew the 8 screws and open the front cover ④, as described in the following paragraph, to make all necessary connections. **The cover is equipped with fixed hinges and must not be removed. To open the cover, follow the instructions in the next paragraph**
- Once the connections have been made proceed to closing the cover by tightening the 8 screws on the front, adhering to the sequence and tightening torque (see specific paragraph on "Closing the front cover").

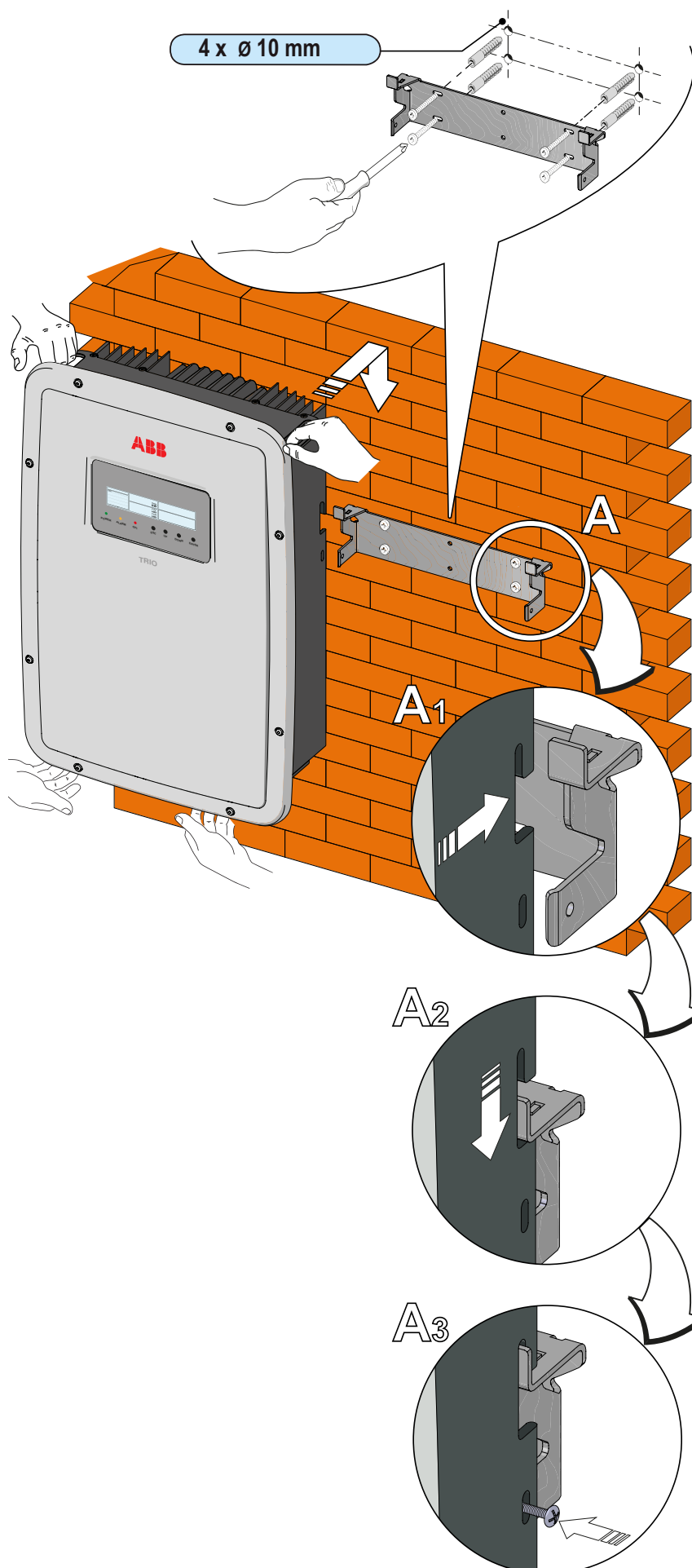

Opening the front cover

The front cover can be easily opened by sliding it over the two rails on both inner sides of the inverter. The sequence to follow is shown below:

- **Unscrew** the 8 screws that secure the front cover ④ (step 1)
- **Open** the cover by pulling it toward you and then pushing it upwards on both sides (steps 2 and 3).

At this stage, avoid misplacing the cover.

- **Secure** the cover open by pushing it forwards and then downwards (steps 4 and 5)

At this point the front cover, which is open and locked, allows access to connection areas placed inside the inverter.

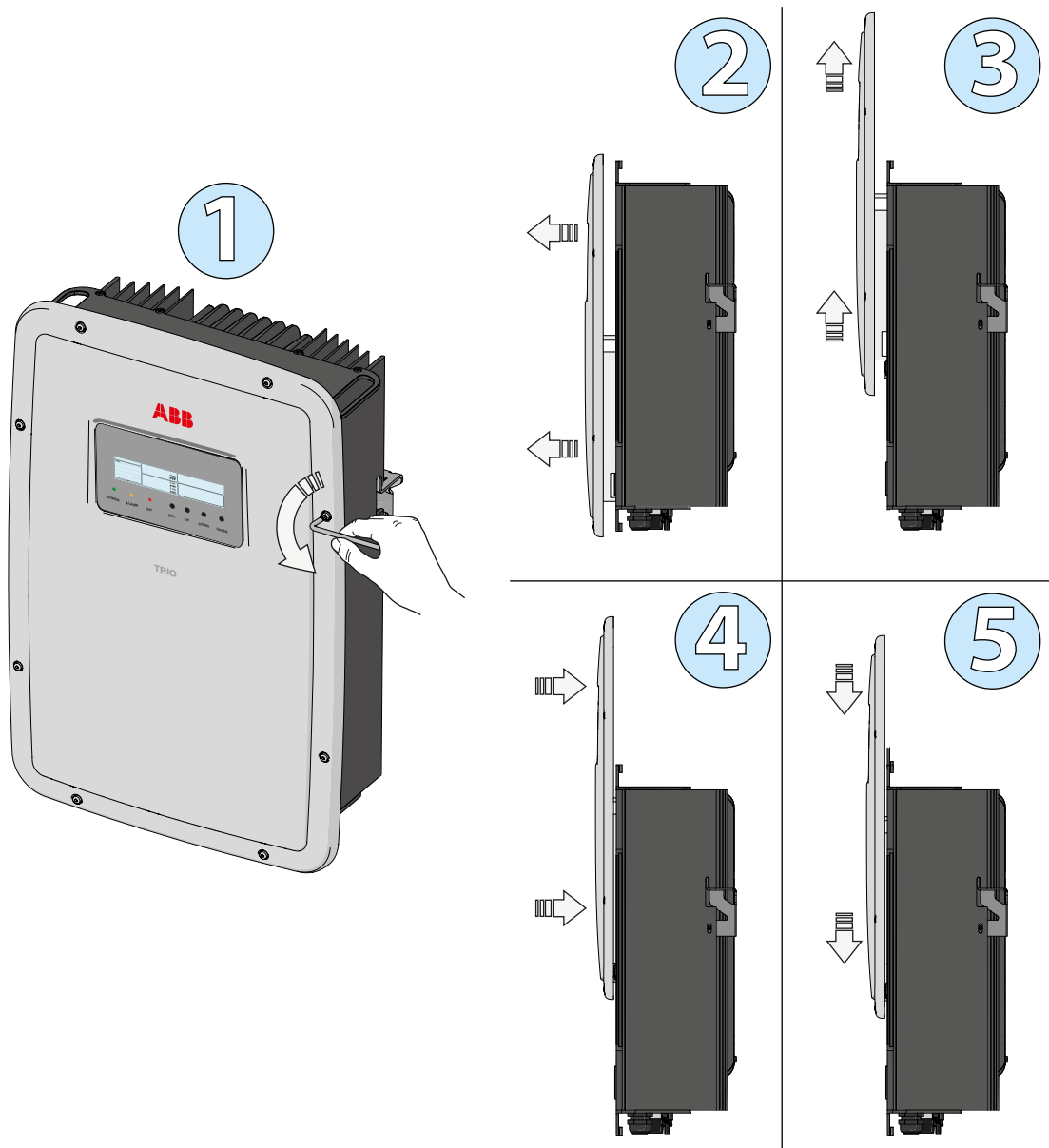

Operations preparatory to PV generator connection

Checking the correct polarity of the strings

Using a voltmeter, check that the voltage of each string observes the correct polarity and falls within the input voltage limits accepted by the inverter (see technical data).



Inversion polarity can cause serious damage

If the voltage without load of the string is near the maximum value accepted by the inverter, it must be borne in mind that with low ambient temperatures the string voltage tends to increase (in a different way according to the photovoltaic module used). In this case, it is necessary to carry out a check of the sizing of the system and/or a check on the connections of the modules of the system (e.g.: number of modules in series higher than the design number).

Checking of leakage to ground of the photovoltaic generator



Measure the voltage present between positive and negative pole of each string with respect to ground.

If a voltage is measured between an input pole and ground, it may be that there is a low insulation resistance of the photovoltaic generator and the installer will have to carry out a check to solve the problem.



Do not connect the strings if a leakage to ground has been found because the inverter might not connect to the grid.

Choice of differential protection downstream of the inverter

All ABB string inverters marketed in Europe are equipped with a device for protection against ground faults in accordance with the safety standard set in Germany by Standard VDE V 0126-1-1:2006-02 (please refer to section 4.7 of the Standard).

In particular, ABB inverters are equipped with a redundancy on the reading of the ground leakage current sensitive to all components of both direct and alternating current. Measurement of the ground leakage current is carried out at the same time and independently by 2 different processors: it is sufficient for one of the two to detect an anomaly to trip the protection, with consequent separation from the grid and stopping of the conversion process.

There is an absolute threshold of 300 mA of total leakage current AC+DC with protection tripping time at a max. of 300 msec.

In addition, there are another three tripping levels with thresholds respectively at 30 mA/sec, 60 mA/sec and 150 mA/sec to cover the “rapid” changes in fault current induced by accidental contact with leaking live

parts. The max. tripping times are progressively shortened as the speed of change in the fault current increases and, starting from the 300 msec/max for the 30 mA/sec change, they are shortened respectively to 150 msec and 40 msec for 60 mA and 150 mA changes.

It should in any case be noted that the integrated device only protects the system against ground faults that occur upstream of the AC terminals of the inverter (namely towards the DC side of the photovoltaic system and consequently towards the photovoltaic modules). The leakage currents that can occur in the AC section between the draw/feed in point and the inverter are not detected and require an external protection device.

For protection of the AC line, on the basis of the aforesaid with regard to the differential protection integrated in ABB inverters, **it is not necessary to install a type B ground fault interrupter.**



In accordance with article 712.413.1.1.1.2 of Section 712 of IEC Standard 64-8/7, we hereby declare that, because of their construction, ABB inverters do not inject ground fault direct currents.



The use of an AC type circuit breaker with differential thermal magnetic protection with tripping current of 300 mA is advisable so as to prevent false tripping, due to the normal capacitive leakage current of photovoltaic modules.

In the case of systems consisting of multiple inverters connected to a single switch with differential protection, it is recommended to install a device that allows the adjustment of the trip value and timing of intervention.

Independent or parallel input channels configuration

The 7.5 and 8.5 kW power inverter versions are equipped with two input channels (thus benefiting from two trackers for MPPT maximum power point tracking) which work independently of one another, which can be paralleled by leveraging a single MPPT.

Strings of photovoltaic modules having the same type and number of panels in series must be connected to each single channel; they must also have the same installation conditions (in terms of orientation to the SOUTH and inclination from the horizontal plane).

When connecting the two input channels in parallel, you must comply with the above requirements in order to benefit from the ability to leverage the full power of the inverter output on a single channel.

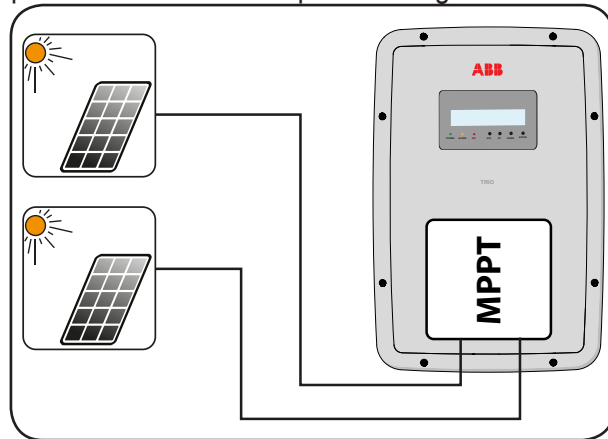

The dual MPPT structure however allows management of two photovoltaic generators which are independent of each other (one for each input channel), and which may differ between themselves with regard to installation conditions, type and number of photovoltaic modules connected in series. A necessary condition for the two MPPT to be used independently is that the photovoltaic generator connected to each of the inputs has a lower power than the power limit of the single input channel and a maximum current lower than the current limit of the single input channel.

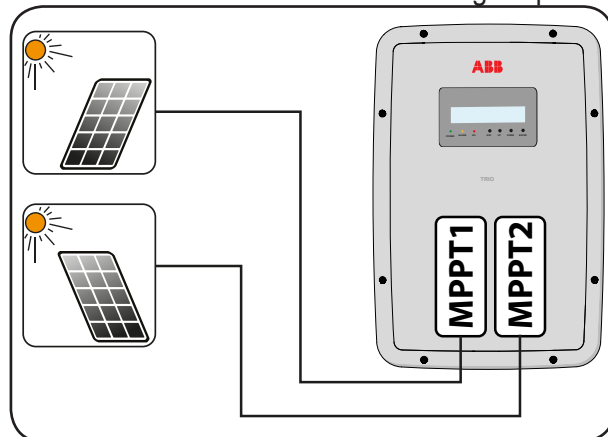

All input parameters that must be met for correct inverter operation are shown in the "technical data" table.

Channel configuration examples

PV generator characteristics	MPPT configuration	Notes
<p>The photovoltaic generator consists of strings having a different number of modules in series from each other.</p> <p>The photovoltaic generator consists of strings that have different installation conditions from each other.</p>	<p>MPPT configuration has to be INDEPENDENT</p>	<p>A NECESSARY condition so that the two MPPTs can be used in independent mode is for the photovoltaic generator connected to each of the inputs to have a power lower than the power limit of the single input channel AND a maximum current lower than the current limit of the single input channel.</p>
<p>The photovoltaic generator consists of strings having the same number of modules in series as each other.</p> <p>The photovoltaic generator consists of strings that have the same installation conditions, that is to say, all the strings have the same inclination from the horizontal and the same orientation to the SOUTH.</p> <p>The photovoltaic generator connected to each of the inputs has a power lower than the power limit of the input channel AND a current lower than the current limit of the input channel.</p>	<p>Possibility of choosing between the configuration with MPPT as INDEPENDENT or PARALLEL</p>	<p>A NECESSARY condition so that the two MPPTs can be used in independent mode is for the photovoltaic generator connected to each of the inputs to have a power lower than the power limit of the input channel AND a maximum current lower than the current limit of the input channel.</p> <p>An ADVISABLE (*) condition so that the two MPPTs can be connected in parallel is for the photovoltaic generator connected to the two inputs to consist of strings made by the same number of modules in series and for all the modules to have the same installation conditions.</p>
<p>(*) <i>This condition is advisable from the point of view of the energy production of the system, not from the point of view of inverter operation.</i></p>		
<p>The photovoltaic generator consists of strings having the same number of modules in series as each other.</p> <p>The photovoltaic generator consists of strings that have the same installation conditions, that is to say, all the strings have the same inclination from the horizontal and the same orientation to the SOUTH.</p> <p>The photovoltaic generator connected to each of the inputs has a power higher than the power limit of the input channel OR a current higher than the current limit of the input channel.</p>	<p>MPPT configuration has to be PARALLEL</p>	<p>A SUFFICIENT (*) condition so that the two MPPTs must be used in parallel mode is for the photovoltaic generator connected to each of the inputs to have a power higher than the power limit of the single input channel OR a maximum current higher than the current limit of the single input channel.</p> <p>An ADVISABLE (**) condition so that the two MPPTs can be connected in parallel is for the photovoltaic generator connected to the two inputs to consist of strings made by the same number of modules in series and for all the modules to have the same installation conditions.</p>
<p>(*) <i>This condition is sufficient from the point of view of the energy production of the system, not from the point of view of inverter operation.</i></p> <p>(**) <i>This condition is advisable from the point of view of the energy production of the system, not from the point of view of inverter operation.</i></p>		



Independent channel configuration (default configuration)

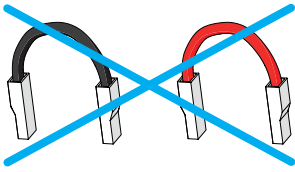

This configuration is factory set and enables independent use of the two input channels (MPPT). This means that the jumpers (supplied) between the positive and negative poles of the two DC input channels do not need to be installed, and that the mode selected in the "SETTINGS>Input Mode" menu must be "INDEPENDENT".

Models without DC disconnect switch

Models with DC disconnect switch

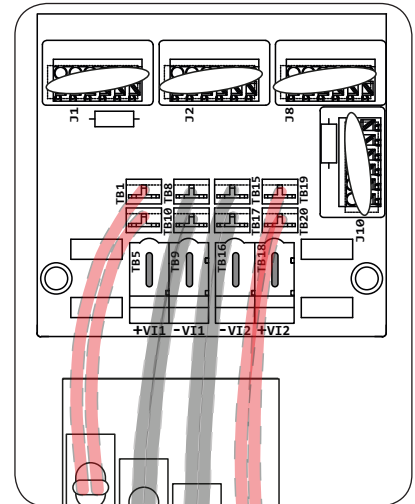
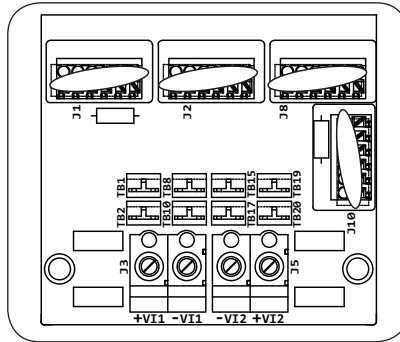

Parallel channel configuration

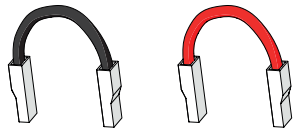

This configuration requires the use of the two input channels (MPPT) connected in parallel. This means that the jumpers (supplied) between the positive and negative poles of the two DC input channels must be installed, and that the mode selected in the "SETTINGS>Input Mode" menu must be "PARALLEL".

Jumper installation (supplied with the inverter) is carried out in two different positions, according to the presence or otherwise of the DC disconnect switch 08 inside the inverter.

TRIO-7.5-TL-OUTD e TRIO-8.5-TL-OUTD - Models without DC disconnect switch

Install the jumpers for the positive poles between terminal **TB1** and **TB19** and that of the negative poles between **TB8** and **TB15**

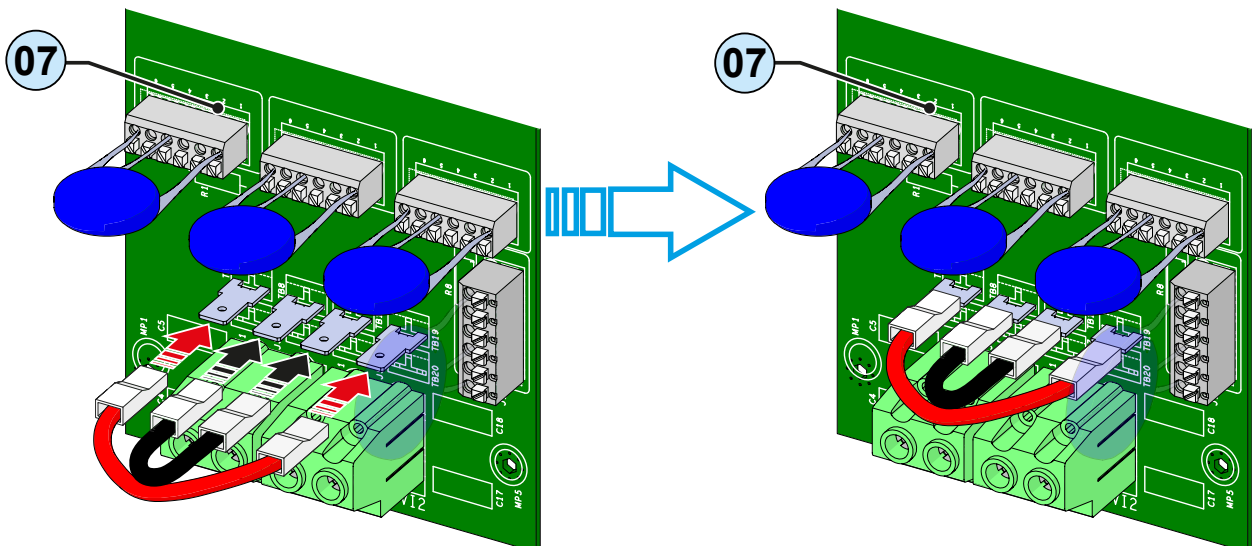

TRIO-7.5-TL-OUTD e TRIO-8.5-TL-OUTD - Models with DC disconnect switch

Install the jumpers for the positive poles between terminal **TB5** and **TB18** and that of the negative poles between **TB9** and **TB16**

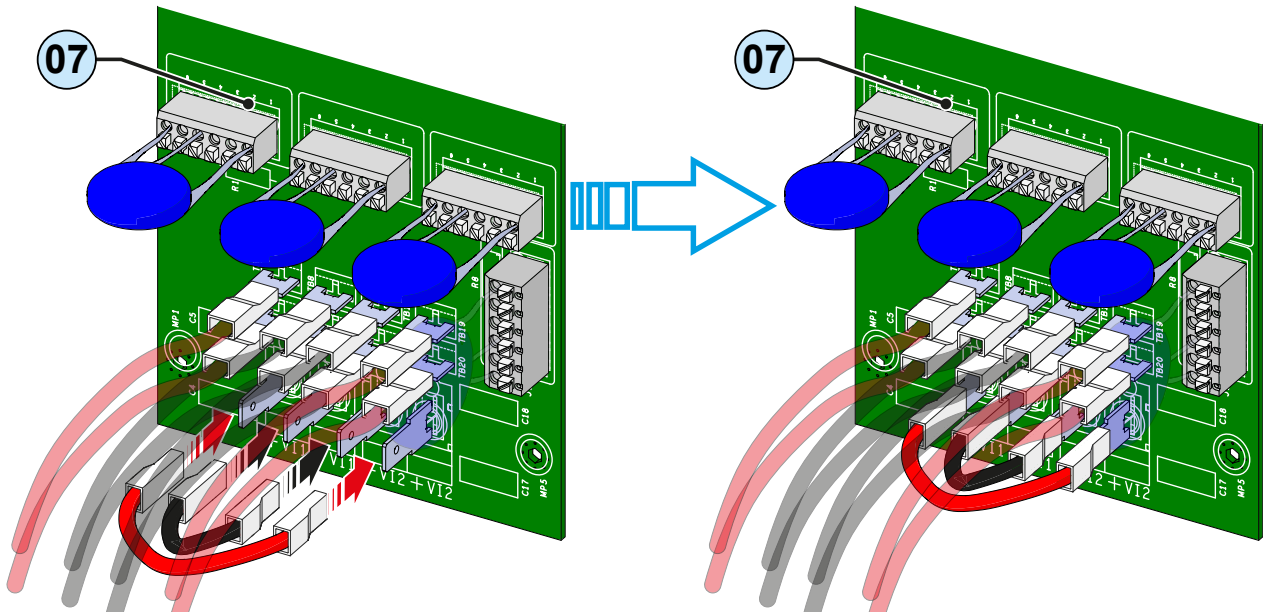

The terminals for connection of the jumpers are positioned below the connection cables of the DC disconnect switch 08



Input connection to PV generator (DC side)

Once preliminary checks have been carried out and no problems found with the photovoltaic system, and the channel configuration has been selected (parallel or independent) you may connect the inputs to the inverter.

The DC side connections are different according to power size and to the presence or otherwise of the DC disconnect switch inside the inverter.

The -S versions accept a direct single strings connection with connectors which are located on the outside of the inverter.



When the photovoltaic panels are exposed to sunlight they provide continuous DC voltage to the inverter.

To avoid risks of electrical shock, all wiring operations must be carried out with the DC disconnect switch (internal or external to the inverter) off.

Connection of inputs - Standard Models

The input connection on the inverter without DC disconnect switch can be done in 2 different ways depending on the number of available input channels.

	TRIO-5.8	TRIO-7.5	TRIO-8.5
No. of input channels	1	2	2
DC cable gland	2 x M25		

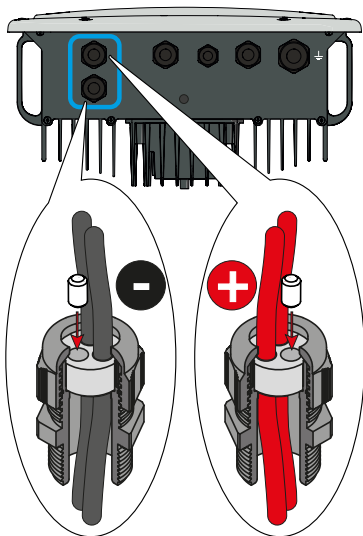

For all inverter models, connection is carried out using the DC output terminal block (23) passing the cables internally through the DC cable gland (18).

The maximum cable diameter accommodated by the DC cable glands is between 10 to 17 mm, while each terminal clamp on the terminal block accepts a cable with a maximum cross-section of 16 mm².

In case you need to connect more than one cable (up to a maximum of 3) to the DC terminal block, the special 3 holed gasket supplied may be installed on the cable gland. This accommodates 3 cables of diameters from 4mm to 7 mm.

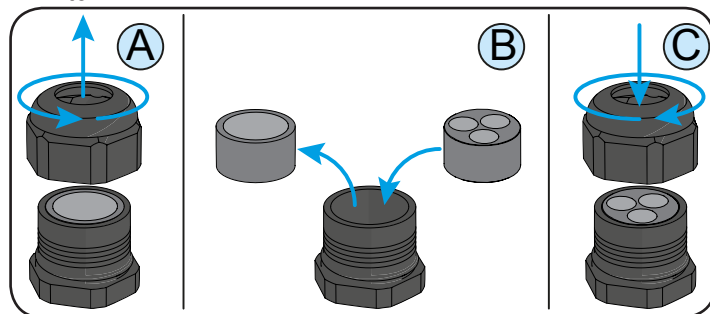

Unused holes in the gasket must be fitted with the appropriate plug that ensures maintenance of the degree of IP65 insulation.

DC cables installation:

- Unscrew the cable clamp and remove the cover
- Enter the appropriate section cable through the DC cable gland and through the 3 holed gasket, where required.
- Connect the cables on to the DC input terminal block.
- Once connection to the terminal block has been completed, retighten the cable gland firmly and check seal.

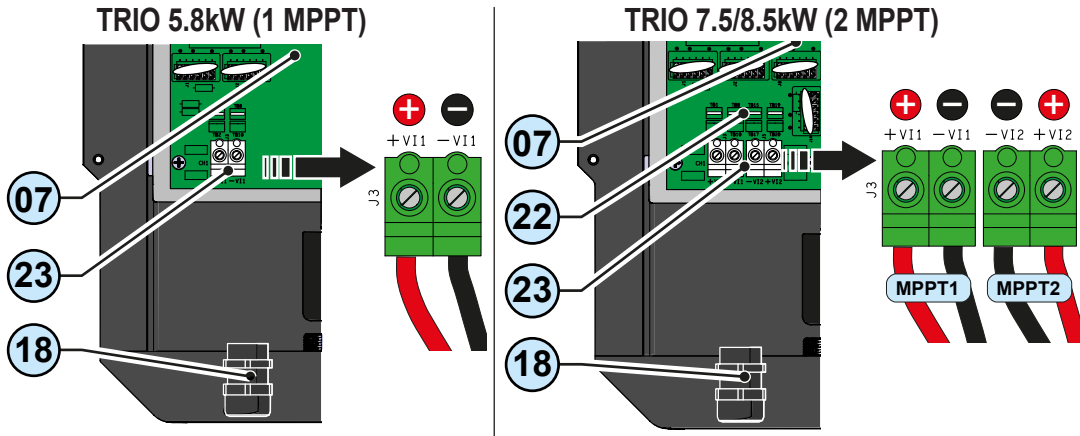

According to the system configuration, check the correct setting of the channels to independent or in parallel mode. An incorrect setting of the input channels can lead to loss of energy production.

Connection of inputs - Models with disconnect switch (-S)

To connect the strings in versions with DC disconnect switch, you will need the quick fit connectors (Weidmüller or Multi-Contact) located on the lower part of the mechanics.

The number of quick fit connectors varies in accordance with the number of input channels. In general, there are two pairs of connectors for each input channel, to which two strings may be connected.

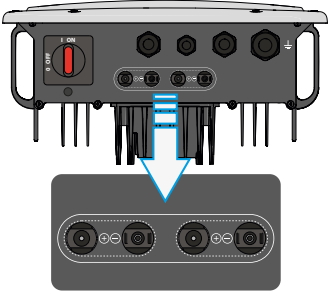
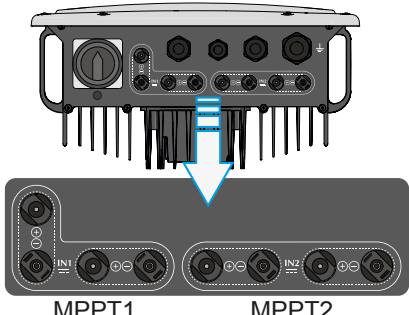
TRIO-5.8	TRIO-7.5	TRIO-8.5
No. of input channels: 1	No. of input channels: 2	
No. of quick fit connectors: 4 (2 couple)	No. of quick fit connectors: 4 + 4 (2 couple per MPPT)	
		
	MPPT1	MPPT2



According to the system configuration, check the correct setting of the channels to independent or in parallel mode. An incorrect setting of the input channels can lead to loss of energy production.



Polarity inversion can cause serious damage. Check polarity before connecting each string!

Connect all the strings required by the system, always checking the seal of the connectors.

The figure below shows a connection example of the string inputs on a TRIO-7.5/8.5 inverter (with dual input channel). Each input channel is connected to a string, while the protective covers are installed to unused connectors



If any string inputs are not required, you must ensure that covers are installed to the connectors, and install any which are missing.



This is necessary both for the inverter seal, and to avoid damage to the free connector which may be used at a later time.

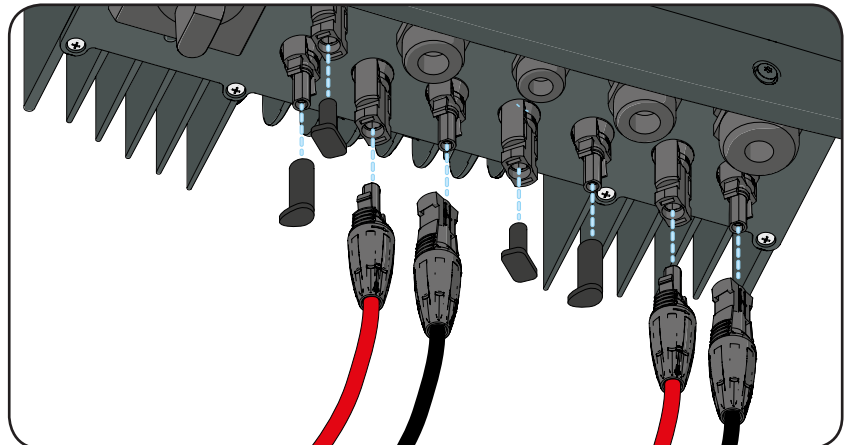

Installation procedure for quick fit connectors

On inverter models with which quick fit connectors are supplied, they may be supplied in two different types:



CAUTION: To avoid damage to the equipment, when attaching cables, pay particular attention to polarity.

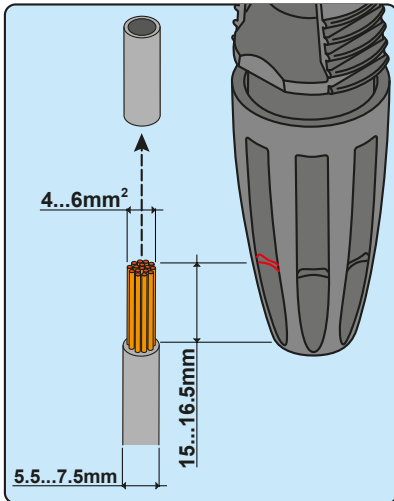

Weidmüller

Installation of Weidmüller connectors does not require any special tooling.

- Strip the cable to which you want to apply the connector (after verifying that it complies with the connector limits)

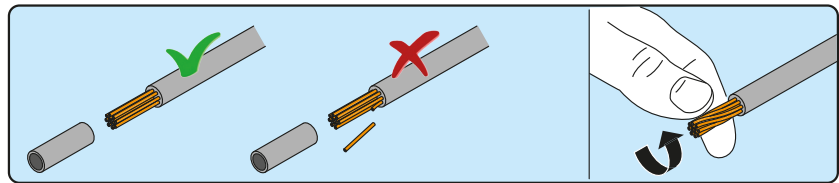

- Insert the wire into the connector until you hear a locking "click"

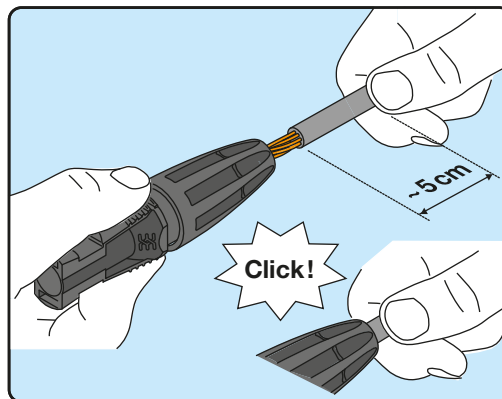

- Tighten the knurled ring nut for optimal clamping

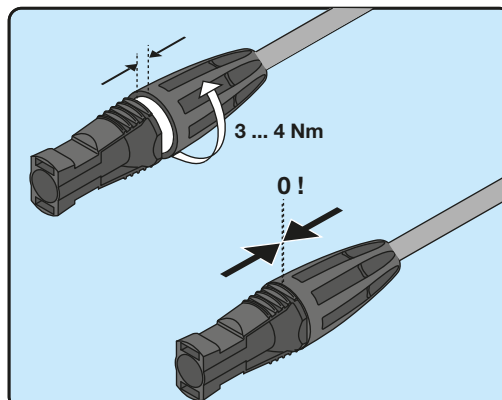

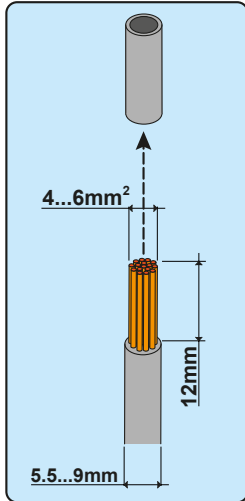

MULTICONTACT (or equivalents)

Installation of Multicontact connectors requires crimping to be carried out with suitable equipment.

- Strip the cable to which you want to apply the connector (after verifying that it complies with the connector limits)

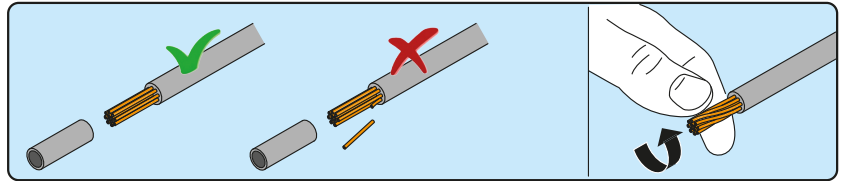

- Apply the terminal to the conductor using suitable crimping pliers

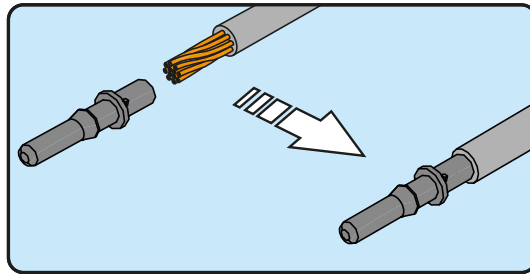

- Insert the cable with the terminal into the interior of the connector, until you hear the click indicating that the terminal is locked inside the connector.

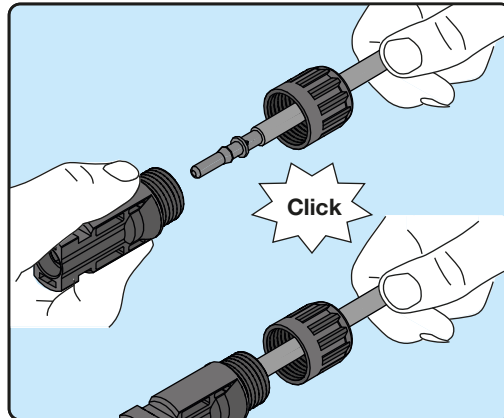

- Firmly tighten the cable gland to finish the operation

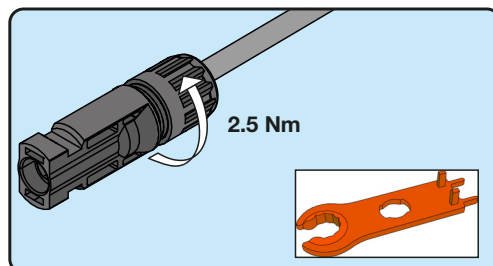

Grid output connection (AC side)

For the connection of the inverter to the grid, you can choose between a star connection (3 phases + neutral) and a delta connection (3 phases). **In any case, connection of the inverter to ground is mandatory.**

The cable you use can be 5-pole (star configuration) or 4-pole (delta configuration) and must pass through the AC cable gland to make the connections to the AC output terminal block.

Characteristics and sizing of the protective earthing cable

ABB inverters must be earthed via the terminal with the protective earth symbol (⊕), using a cable with an appropriate conductor cross-section for the maximum ground fault current that the generating system might experience.



Any failure of the inverter when it is not connected to earth through the appropriate terminal is not covered by the warranty.

In compliance with standard IEC 62109 it is necessary:

- To install a copper earthing cable on the AC output terminal block (31) with a minimum section of 10 mm².

- Alternatively it is possible to install a second earthing cable (with the same section as the one installed on the AC output terminal block (31) on the connection point located on the underside of the inverter and marked with the symbol ⊕.

Installation of a second protective earthing cable is also required by regulations in force in certain countries of installation.



If necessary, carefully read the instructions provided in the paragraph "Installation of the second protective earthing cable".

Load protection switch (AC disconnect switch)

It is recommended that the inverter AC connection line be fitted with a device to protect against maximum current and leakage to ground, with the following characteristics:

	TRIO-5.8-TL-OUTD	TRIO-7.5-TL-OUTD	TRIO-8.5-TL-OUTD
Type	Automatic circuit breaker with differential thermal-magnetic protection		
Voltage/current rating	400V / 16A		
Magnetic protection characteristic	B/C		
Differential protection type	A/AC		
Differential sensitivity	300mA		
Number of poles	3/4		

Characteristics and sizing of the line cable

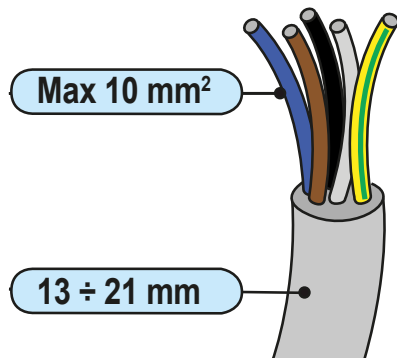

The cross-section of the AC line conductor must be sized in order to prevent unwanted disconnections of the inverter from the grid due to high impedance of the line that connects the inverter to the power supply; If the impedance is too high it causes an increase in the AC voltage that, on reaching the limit set by the standards in the country of installation, causes the inverter to switch off.

The table shows the maximum line conductor length in relation to the section of the conductor itself:

Line conductor cross section (²mm)	Line conductor maximum length (mt)		
	TRIO-5.8-TL-OUTD	TRIO-7.5-TL-OUTD	TRIO-8.5-TL-OUTD
4	55m	40m	35m
6	80m	60m	55m
10	135m	105m	90m

The values are calculated in nominal power conditions, considering:

- loss of power along the line no greater than 1%
- use of copper cable, with HEPR rubber insulation and positioned in open air



Connection to terminal block AC side

To avoid risks of electrical shock, all wiring operations must be carried out with the disconnect switch downstream of the inverter (grid side) off.

Be careful not to invert any phase with neutral!

High leakage current. Grounding is essential before connection to the power supply network.

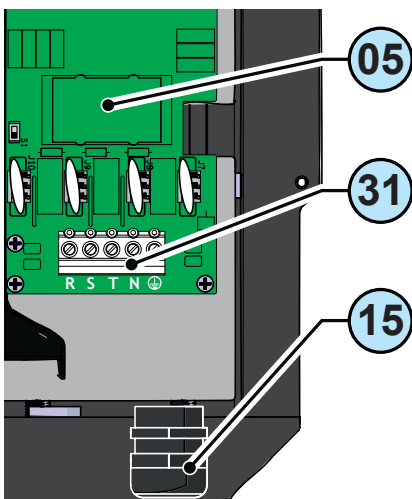

For all inverter models, connection is carried out using the AC output terminal block ³¹ passing the cables internally through the AC cable gland ¹⁵.

The maximum acceptable cable diameter is between 13 to 21 mm, while each terminal clamp on the terminal block accepts a cable with a maximum cross-section of 10 mm².

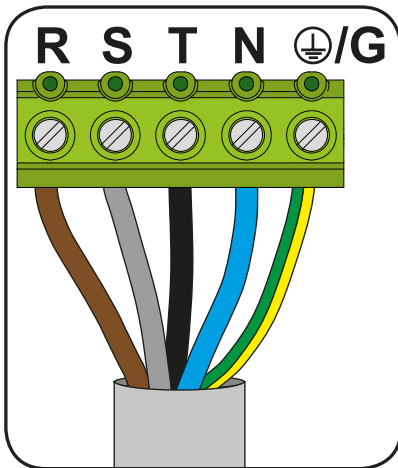

AC cable installation:

- Unscrew the cable gland and remove the cover
- Enter the appropriate section cable through the AC cable gland
- Connect the conductors Neutral, R, S, T and Protective Earth (⊕ / G) to the terminals on the AC output terminal block.

Connection of the inverter to the grid may be three wire (triangle configuration) or four wire (star configuration).

- Once connection to the terminal block has been completed, retighten the cable gland firmly and check seal.

Installation of the second protective earthing cable

Should it be necessary to install a second protective earthing cable, follow the procedure described below:

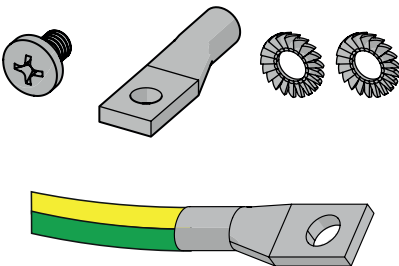

- From among the components supplied, find the M6 screw, the two knurled washers and the cable lug

- Fit the cable lug on the protective earthing cable.
The cable lug accepts cables with a cross-section of from 4 to 6 mm²

- Fasten the cable lug using the screw and the two washers, following the sequence illustrated below and tightening to a torque of 4.1 Nm.
The connection point is located on the underside of the inverter.

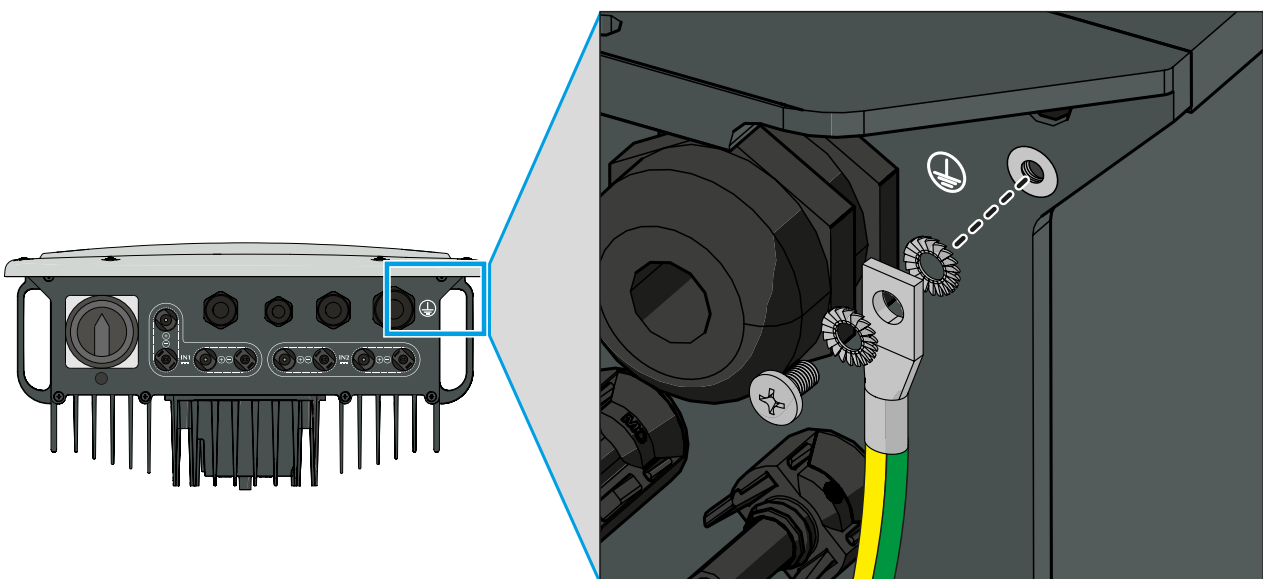

Communication and control board

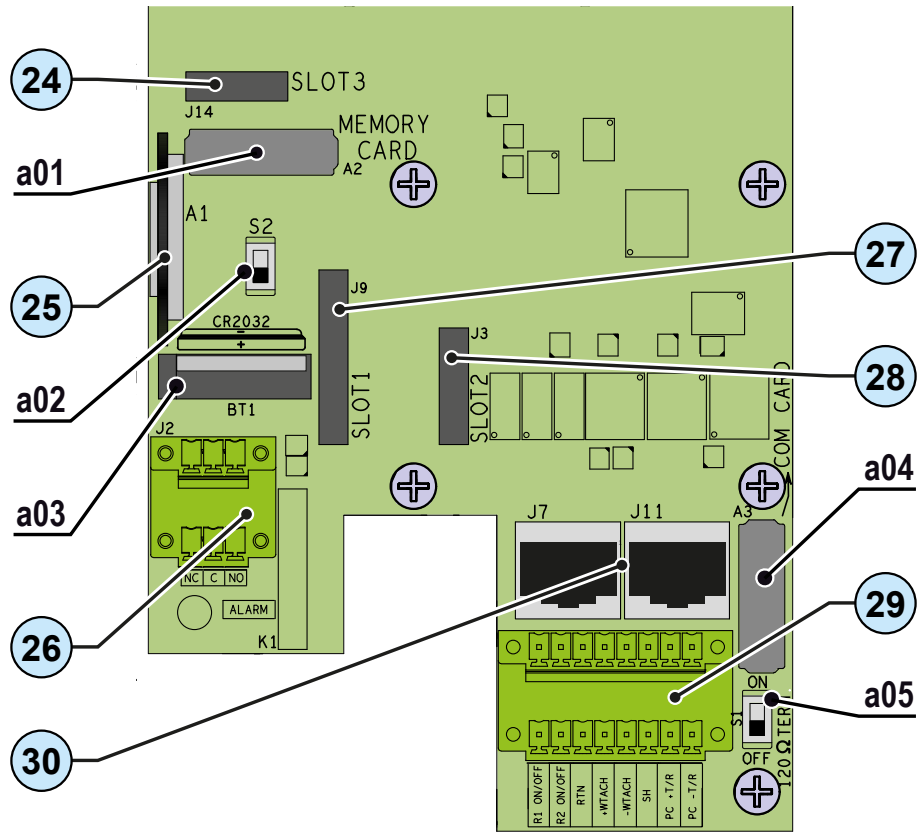

communication and control board

Ref. inverter	Ref. manual	Description
J14	24	SLOT 3 - Connector for WIFI modules installation (NOT ACTIVE)
A1	25	SD CARD housing
J2	26	Connection to the multi-function relay
J9	27	SLOT 1 - Connector for radio module or Ethernet card installation
J3	28	SLOT 2 - Connector for PMU card installation
J4	29	Connection of the RS485 (PC) line and of the remote ON/OFF and of the Tachometer signal (WIND version)
J7 and J11	30	Connection of the RS485 (PC) line on RJ45 connector
A2	a01	Inverter data memory card housing
S2	a02	Switch to set the inverter to normal or service mode
BT1	a03	Battery housing
A3	a04	RS485 (PC) communication card housing
S2	a05	RS485 line (PC) termination resistance selector switch

Connections to the communication and control board

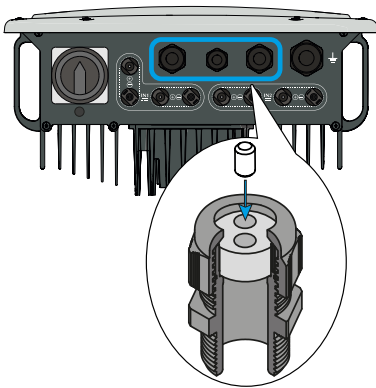

Each cable which must be connected to the communication and control board must pass through one of the three service cable glands.

- An M20 that takes cables from 7 mm to 13 mm in diameter. Gaskets with two holes are supplied as standard to insert into the cable gland, which enables two separate cables of a maximum cross-section of 5 mm to be accommodated
- Two M25 that take cables from 10 mm to 17 mm in diameter. Gaskets with two holes are supplied as standard to insert into the cable gland, which enables two separate cables of a maximum cross-section of 6 mm to be accommodated

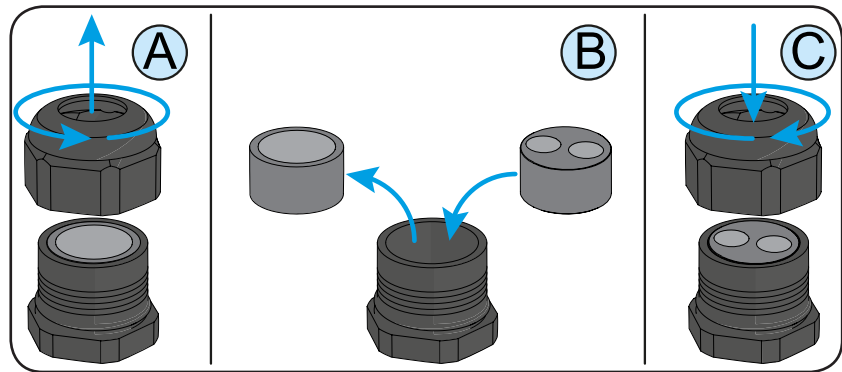

Remote control connection

The connection and disconnection of the inverter to and from the grid can be controlled through an external control.

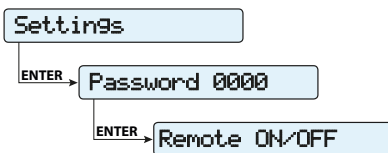

The function must be enabled in the relevant menu. If the remote control function is disabled, the switching on of the inverter is dictated by the presence of the normal parameters that allow the inverter to connect to the grid.

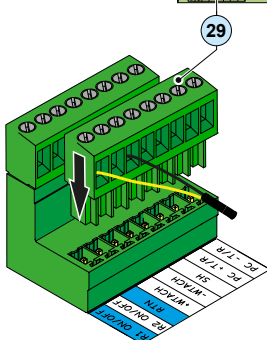
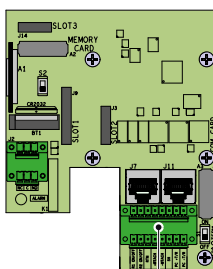

If the remote control function is operating, besides being dictated by the presence of the normal parameters that allow the inverter to connect to the grid, the switching on of the inverter also depends on the state of the R1 ON/OFF terminal compared to the RTN terminal present on the connector 29 of the communication card 06.

When the R1 ON/OFF signal is brought to the same potential as the RTN signal (i.e. by making a short circuit between the two terminals of the connector), this causes the inverter to disconnect from the grid. The remote control OFF condition is shown on the display.

The connections of this control are made between the “R1 ON/OFF” input and “RTN”.

Since this is a digital input, there are no requirements to be observed as regards cable cross-section (it only needs to comply with the sizing requirement for passing cables through the cable glands and the terminal connector).

Configurable Relay connection (ALARM)

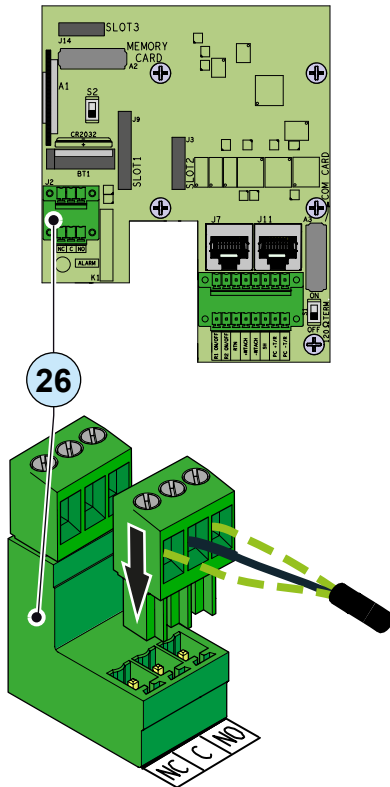

The inverter is equipped with a multifunction relay with configurable activation. It can be connected with normally open contact (being connected between the NO terminal and the common contact C) and with normally closed contact (being connected between the NC terminal and the common contact C).

Different types of devices (light, sound, etc.) can be connected to the relay, provided they comply with the following requirements:

Alternating current

Maximum Voltage: 240 V AC

Maximum Current: 1 A

Direct current

Maximum Voltage: 30 V DC

Maximum Current: 0.8 A

Cable requirements

External diameter: from 5 to 17 mm

Conductor cross-section: from 0.14 to 1.5 mm²

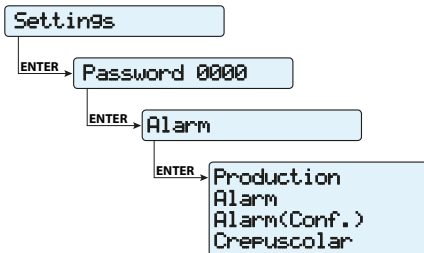

This contact can be used in different operating configurations that can be selected by accessing the "SETTINGS → Alarms" menu.

Serial Connection Communication (RS485 PC)

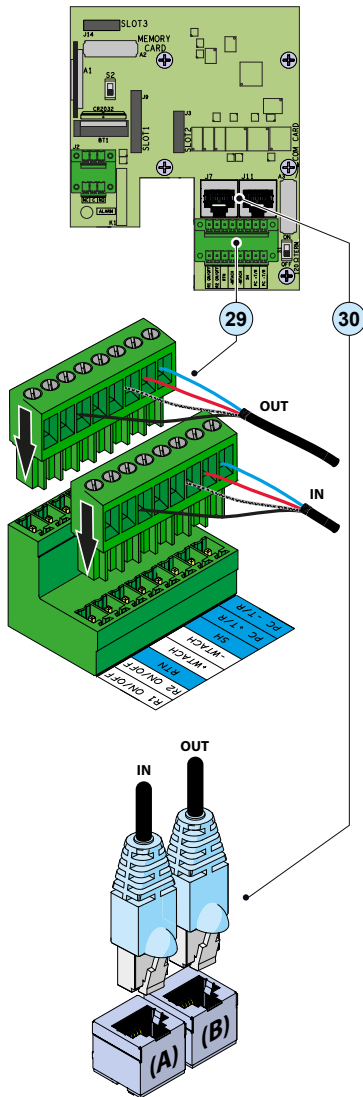

On the inverter there is a RS485 communication line, dedicated to connecting the inverter to monitoring devices or to carrying out "daisy-chain" ("in-out") connections of multiple inverters. The line may also be used to store settings with the dedicated advanced configuration software.

Cables connecting the RS485 line (PC) may use two different types of connection:

- **Connection of the conductors using the terminal connectors 29 (PC +T/R, PC -T/R, SH and RTN)**

The SH connection must be used for connecting the shielding boot(s) of the cable(s).

- **Connection of conductors with RJ45 connectors 30**

The two RJ45 connectors (A) and (B) available for the RS485 (PC) communication, are equivalent to each other and can be used interchangeably for the arrival or for the output of the line in realising the daisy chain connection of the inverters.

The same is true for connections made using the terminal connectors 29.

Table: crimping diagram for RJ45 connectors

Pin No.	Function
3	+T/R
5	-T/R
7	RTN
1, 2, 4, 6, 8	not used

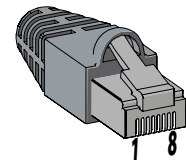

Use a connector with metal body to provide cable shield continuity!

For long distance connections, the connection on terminal connector is preferable using a shielded twisted pair cable with characteristic impedance of $Z_0=120$ Ohm like the one shown on the following table:

Signal	Symbol
Positive data	+T/R
Negative datum	-T/R
Reference	RTN
Shield	SH



Shield continuity must be provided along the communication line using the SH terminal and must be grounded at a single point.

Monitoring and control systems

The RS485 line can be used to set up a line of communication which, when connected to a monitoring device, enables the operation of the photovoltaic system to be kept under control. Depending on the device used monitoring can be *local or remote*.

Procedure for RS485 connection to a monitoring system

Connect all the units of the RS485 chain in accordance with the daisy-chain model in compliance with the correspondence between the signals, and activate the termination resistance of the communication line in the final element of the chain by switching the a05 control (to the ON position).



The communication line must also be terminated on the first element of the chain which normally corresponds to the monitoring device.

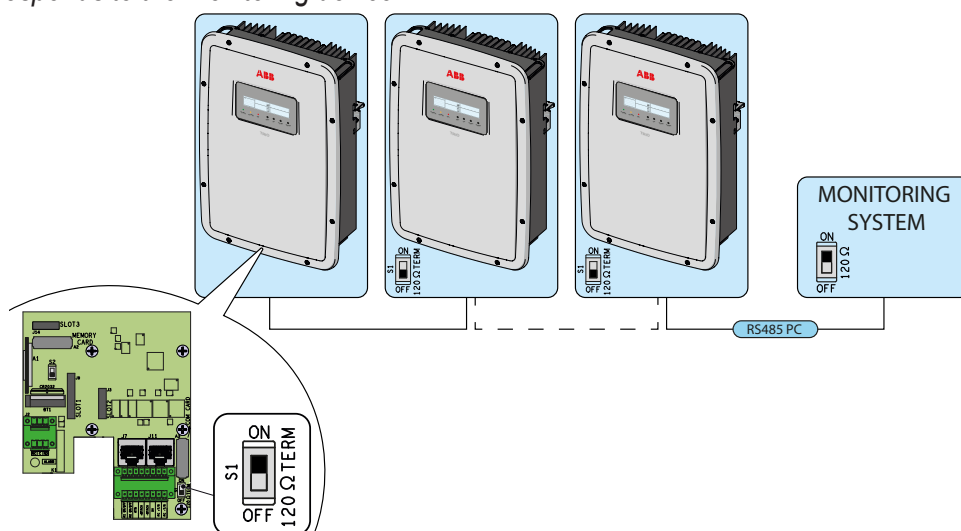

When connecting a single inverter to the monitoring system, activate the termination resistance of the communication line by switching the a05 control (to the ON position).

Set a different RS485 address on each inverter in the chain. **No inverter can have “Auto” as an address.** An address can be freely chosen between 2 and 63.

The setting of the address on the inverter is done through the display and the keyboard (see the specific chapter).



*It is recommended not to exceed a length of 1000m for the communication line.
The maximum number of inverters that can be connected to the same RS485 line is 62.*

When a RS-485 connection is being used, if one or more inverters are added to the system at a later time, it is necessary to remember to reset to OFF the switch on the termination resistance being used on the inverter which previously was the last in the system.

Each inverter is sent with a preset RS485 address of two (2) and with the switch for setting the termination resistance a05 in the OFF position.

Closing the front cover

At the end of the stage of connecting and configuring the inverter and before proceeding with the commissioning, the inverter's cover must be closed.

IP65

During the installation of the cover, the installation sequence must be respected as well as the tightening torque of the 8 screws (set out in the paragraph on technical data) in order to keep the IP level of the inverter unchanged

- Close the cover following the first 4 steps set out in the diagram.
- Insert and screw in the 8 fixing screws.
- Tighten the screws respecting the sequence and the tightening torque.

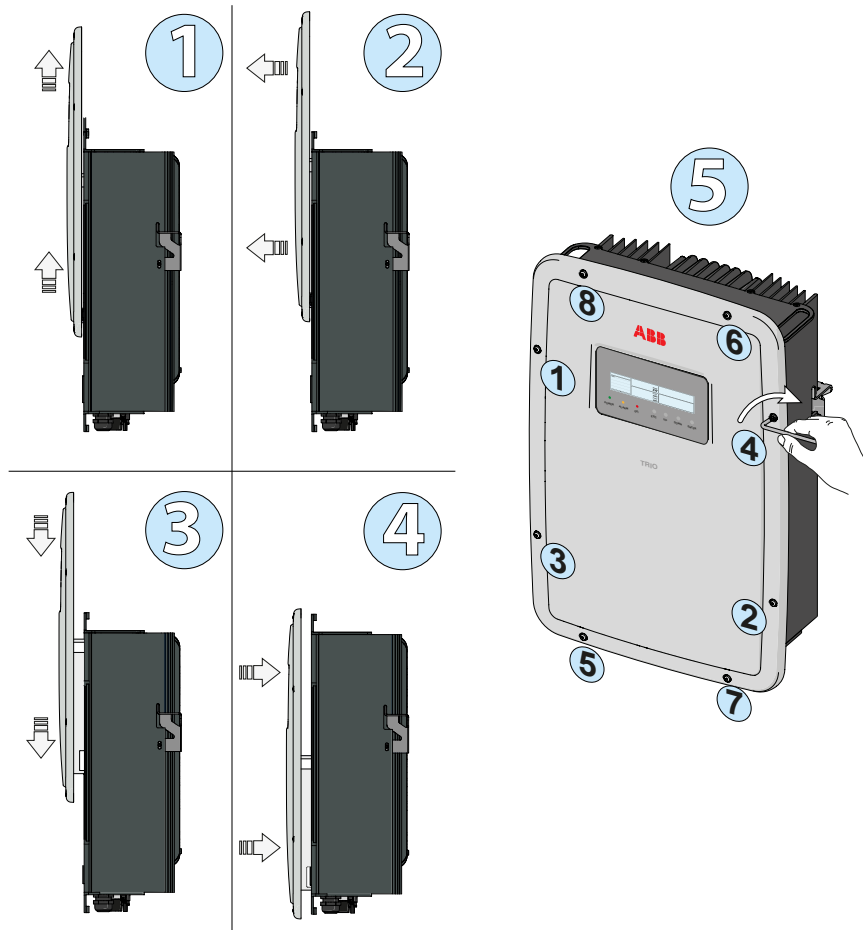

At the end of the stage of installing the front cover, it is possible to proceed with the commissioning of the inverter.

General conditions

One of the first rules for preventing damage to the equipment and to the operator is to have a thorough knowledge of the INSTRUMENTS. We therefore advise you to read this manual carefully. If you are not sure about anything or there is discrepancy in information, please ask for more detailed information.



Do not use the equipment if:

- *you do not have suitable qualifications to work on this equipment or similar products;*
- *you are unable to understand how it works;*
- *you are not sure what will happen when the buttons or switches are operated;*
- *you notice any operating anomalies;*
- *there are doubts or contradictions between your experience, the manual and/or other operators.*

ABB cannot be held responsible for damage to the equipment or the operator if it is the result of incompetence, insufficient qualifications or lack of training.

Display and keyboard



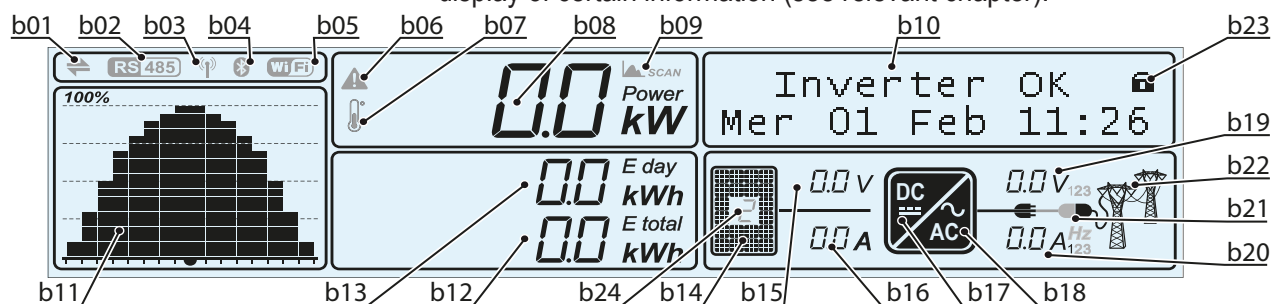

Display fields and symbols description

Using the display, operating parameters for the equipment are shown. signals, alarms, channels, voltages, etc.

The display, when in operation, behaves dynamically, allowing cyclical display of certain information (see relevant chapter).



Ref. Description

b01	Indicates transmission and reception of data through the RS485 line
b02	Indicates presence of the RS485 communication line
b03	Indicates presence of the radio communication line (radio module board installed)
b04	Indicates presence and readiness of the Bluetooth communication line (NOT available)
b05	Indicates presence and readiness of the WiFi communication line (NOT available)
b06	Reports an active power derating for out-of-range input voltage or power restrictions set by the grid manager or by the display
b07	Reports a power derating due to high internal temperature
b08	Instantaneous power placed on the grid
b09	MPPT SCAN function active
b10	Text lines to cyclically display the inverter parameters, error codes, and for menu navigation
b11	Graph of power introduced to grid (from 0 to 100%). Timescale can be set to 8/16/24 hours
b12	Displays the total energy from the inverter installation
b13	Shows the energy produced throughout the day
b14	Indicates that the PV generator voltage is greater than the inverter Vstart
b15	Input voltage (DC)
b16	Input current (DC)
b17	Indicates the DC/DC input circuit (Booster)
b18	Indicates the DC to AC conversion circuit
b19	Output voltage of phase highlighted
b20	Output current of phase highlighted. At the end of the currents display the grid frequency (Hz) is shown
b21	Connection to the grid:  Inverter not connected /  Inverter connected
b22	State of grid voltage: Icon absent: grid voltage not present Flashing icon: grid voltage present but outside parameters set by the standard grid Icon present: Grid voltage present and within parameters set by the standard grid
b23	Main menu scrolling mode:  CYCLIC : Cyclic display of the main parameters of the inverter.  LOCKED : Display locked on the screen to be constantly monitored.
b24	Indicates the channel which refers to the values of voltage and input current displayed. In the event of independent channels, parameters are displayed cyclically (channel 1 or 2)

Description of keyboard and LED Panel

Using the combination of keyboard keys, under the display, it is possible to set values or scroll through the data items to view them. LED indicators are located alongside the keyboard, indicating the operating state of the inverter.

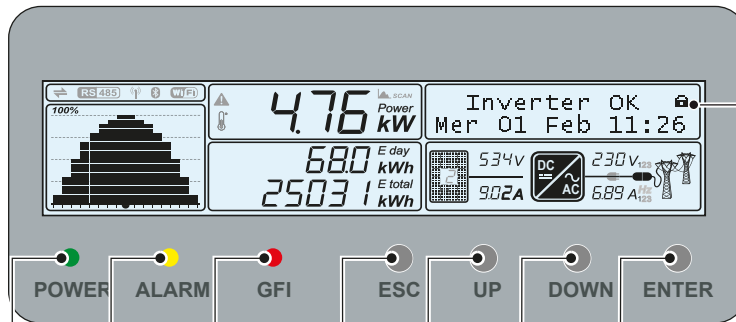

By pressing and holding the ENTER key, the cyclical display of the parameters can be:

-  Locked
-  Cyclical

Allows you to confirm the operation or enter the data set.

Allows you to read through the data in descending order on the display, or when inserting, correct the value set by reducing it

Allows you to read through the data in ascending order on the display, or when inserting, correct the value set by increasing it

Allows you to exit the current mode

The "GFI" (ground fault) LED indicates that the inverter has detected a ground fault in the DC side photovoltaic generator. When this fault is detected, the inverter immediately disconnects from the grid and displays the relevant error indication on the LCD display.

Indicates that the inverter has detected an anomaly. The type of problem will be shown in the display

Indicates that the inverter is functioning correctly.

When the unit is commissioned, while the grid is checked, this LED blinks. If a valid grid voltage is detected, the LED remains continuously lit, as long as there is sufficient sunlight to activate the unit. Otherwise, the LED will continue to blink until the sunlight is sufficient for activation. In this phase, the LCD display shows the message "Awaiting sun..."

The LEDs, in various multiple available combinations, can signal multiple conditions other than the original single condition; see the various descriptions explained in the manual.

The Keys, in various multiple available combinations, allow you to access actions other than the original single action; see the various descriptions explained in the manual.

General conditions

Before checking the operation of the equipment, it is necessary to have a thorough knowledge of the INSTRUMENTS chapter and the functions that have been enabled in the installation.

The equipment operates automatically without the aid of an operator; operating state is controlled through the instruments.

The interpretation or variation of some data is reserved exclusively for specialized and qualified staff.



The incoming voltage must not exceed the maximum values shown in the technical data in order to avoid damaging the equipment.

Consult the technical data for further details.

Even during operation, check that the environmental and logistic conditions are correct (see installation chapter).

Make sure that the said conditions have not changed over time and that the equipment is not exposed to adverse weather conditions and has not been isolated with foreign bodies.

Monitoring and data transmission

As a rule, the inverter operates automatically and does not require special checks. When there is not enough solar radiation to supply power for export to the grid (e.g. during the night), it disconnects automatically and goes into stand-by mode.

The operating cycle is automatically restored when there is sufficient solar radiation. At this point, the luminous LEDs on the LED panel will indicate this state.

User interface mode

The inverter is able to provide information about its operation through the following instruments:

- Warning lights (luminous LEDs)
- LCD display for displaying operating data
- Data transmission on the dedicated RS-485 serial line. Data may be collected by a PC or a data logger with an RS-485 port. Contact the ABB support service with any queries about device compatibility.

Types of data available

The inverter provides two types of data, which can be retrieved through the special interface software and/or the display.

Real-time operating data

Real-time operating data can be transmitted on request through the communication lines and are not recorded in the inverter.



Internally stored data

The inverter internally stores a set of data that are necessary for processing statistical data and an error log with time marking.

Measurement tolerance

The data supplied by the inverter may differ from measurements taken by certified measuring instruments (e.g. output meters, multimeters and grid analysers); since the inverter **is not a measuring instrument** it has wider tolerances for the measurements it makes.

The tolerances are generally:

- ±5% for real-time measurements with output power below 20%
- ±3% for real-time measurements with output power above 20%
- ±4% for all statistical data

Commissioning



Do not place objects of any kind on the inverter during operation!
Do not touch the heat sink while the inverter is operating!

Some parts may be very hot and could cause burns.

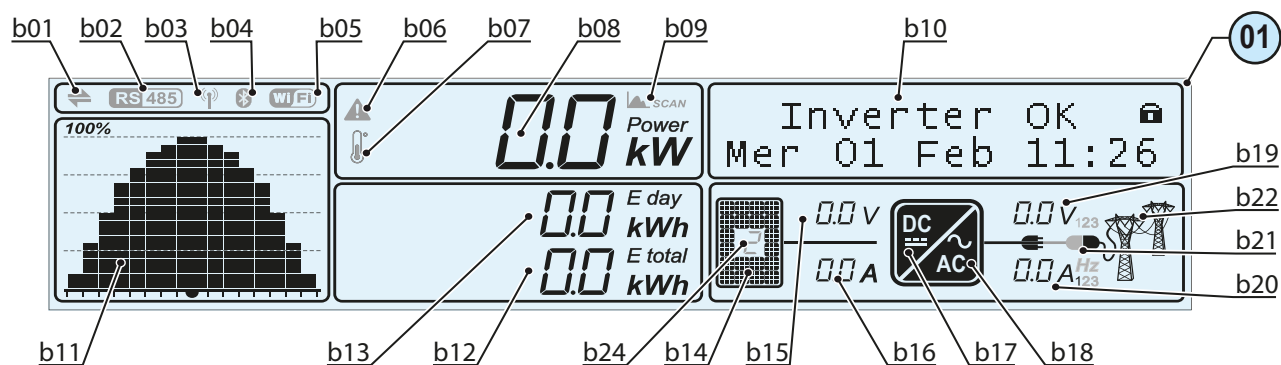

Before proceeding with commissioning, make sure you have carried out all the checks and verifications indicated in the section on preliminary checks.

The procedure for commissioning the inverter consists of the following steps:

- Close the AC disconnect switch to supply the inverter with the grid voltage

- Close the DC disconnect switch to supply the inverter with the photovoltaic generator voltage.

If the inverter is equipped with a DC disconnect switch (-S models), turn the DC disconnect switch ¹⁴ to the ON position.

- When the inverter is connected to the power supply, the display will show a guided configuration procedure. Press ENTER to set the following:

- Inverter date and time

- Parallel or independent mode configuration of the input channels
The inverter is shipped from the factory with the input channels set to INDEPENDENT. Should you decide to use the channels in PARALLEL mode, you should fit the special jumpers supplied and select the correct input configuration mode

- Selection of grid standard and corresponding display language.

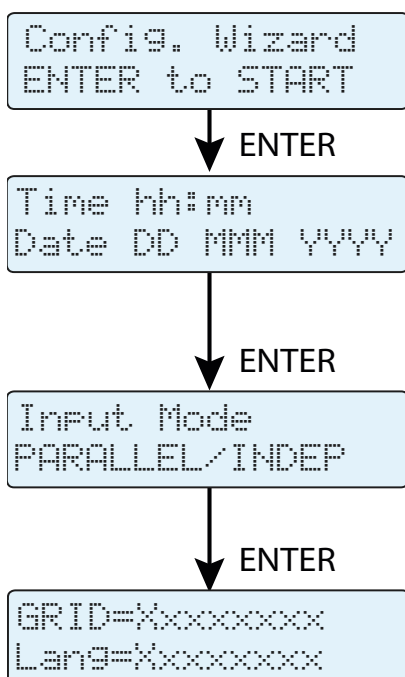

The grid standards that can be selected are listed in the following table:

Displayed name	Country Grid Standard	Display language
VDE 0126	GERMANY-VDE0126@400V	ENGLISH
RD 1699	SPAIN RD1699 @ 400V	SPANISH
UK G83	UK – G83 @ 400V	ENGLISH
UK G59	UK – G59 @ 400V	ENGLISH
IRELAND	IRELAND @ 400V	ENGLISH
AS 4777	AUSTRALIA @ 400V	ENGLISH
ISRAEL.	ISRAEL @ 400V	ENGLISH
FRANCE	FRANCE LL 2013 @ 400V	FRENCH
NETHERL.	NETHERLANDS @ 400V	DUTCH
GREECE	GREECE @ 400V	ENGLISH
PORTUGAL	PORTUGAL @ 400V	ENGLISH
CORSICA	CORSICA @ 400V	FRENCH
HUNGARY	HUNGARY @ 400V	ENGLISH
TAIWAN	TAIWAN @ 400V	ENGLISH
CZECH	CHECA Republic @ 400V	CZECH
VDE 4105	GERMANY – VDE AR-N-4105 @ 400V	GERMAN
CEI021 EX	ENEL CEI-021 @ 400V EXTERNAL Prot.	ITALIAN
CEI021 IN	ENEL CEI-021 @ 400V INTERNAL Prot.	ITALIAN
S.AFRICA	SOUTH AFRICA @ 400V	ENGLISH
RD 1565	SPAIN RD 1565 @ 400V	SPANISH
C1011 100	BELG C10-11 100% @ 400V	FRENCH
C1011 110	BELG C10-11 110% @ 400V	FRENCH
BRAZIL	BRAZIL @ 380V	ENGLISH
TURKEY LV	TURKEY LV @400V	ENGLISH
ROMANIA	ROMANIA @400V	ENGLISH
SLOVENIA	SLOVENIA @400V	ENGLISH
TURKEY HV	TURKEY HV @400V	ENGLISH
CEI 016	CEI-016 @ 400V	ITALIAN
EN 50438	EN50438 generic @ 400V	ENGLISH
FRANCE 14	FRANCE LL 2014 @ 400V	FRENCH
THAIL MEA	THAILAND MEA @ 400V	ENGLISH
THAIL PEA	THAILAND PEA @ 380V	ENGLISH
SINGAPORE	SINGAPORE @ 400V	ENGLISH



The list of grid standards given in the table was valid at the time of issue of the manual. It will be continually updated as new country standards with which the inverter is compatible are introduced



Once the guided configuration procedure is completed, the inverter restarts to apply the parameter settings

$V_{in} < V_{start}$

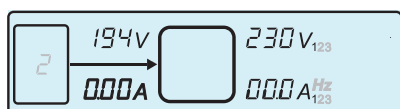

- When the inverter comes on again, it first checks the input voltage:
 - If the DC input voltage is lower than the V_{start} voltage (voltage required for the inverter to connect to the grid), icon **b14** remains off and the message "Waiting Sun" is displayed in **b10**.

$V_{in} > V_{start}$

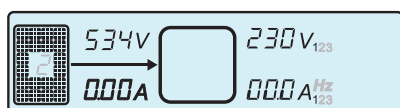

- If the DC input voltage is higher than the V_{start} voltage, icon **b14** is displayed and the inverter goes to the next stage in the checks. In both cases the input voltage and current are displayed in fields **b15** and **b16**.

- The inverter checks the grid parameters. Icon **b22**, which represents the distribution grid, can have the following statuses:
 - Blank, if there is no grid voltage.
 - Flashing, if there is grid voltage, but it is outside the range required by the installation country standard.

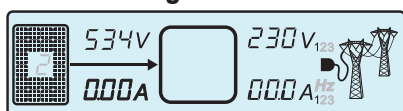
Vgrid OK

- Steady, if the grid voltage it is within the range required by the installation country standard. In this condition, the inverter starts the grid connection sequence.

This verification can take several minutes (from a minimum of 30 seconds up to several minutes), depending on the grid conditions and settings relative to the country standard

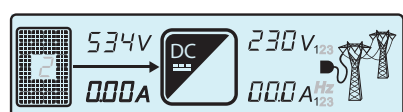

- At this point icon **b17** will flash; this indicates the start-up of the DC-DC (booster) circuit. This icon will remain on and steady when the DC-DC circuit is operating normally (this icon usually flashes only for a few seconds).

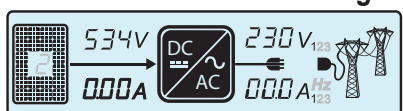

Immediately after this, icon **b18**, which indicates the DC-AC (inverter) circuit, will also behave normally.

Inverter not connected to the grid

- Immediately after this the grid connection will start. During this stage the icons on line **b21** will be displayed in sequence until the inverter is connected. After the inverter is connected, all the icons on line **b21** will remain on and steady.

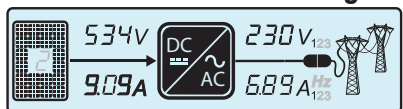
Inverter connected to the grid

If the inverter disconnects from the grid, the icons in the left-hand part (cable and plug) of line **b21** will stay on.

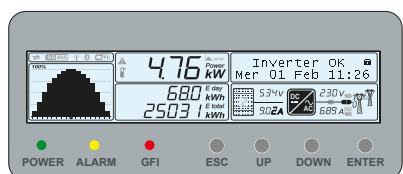

- Once the connection sequence has been completed, the inverter starts to operate and indicates that it is operating correctly by means of a sound and the green LED on the LED panel **02** coming on steady. This means there is sufficient solar radiation to feed power into the grid.

- If the grid check does not give a positive result, the unit will repeat the procedure until all the parameters required for grid connection (grid voltage and frequency, insulation resistance) are within the range. During this procedure, the green LED flashes.



After the inverter has started for the first time, it may be configured from the display menu or by using the dedicated Aurora Manager LITE software.



To address any problems that may occur during the initial stages of operation of the system and to ensure the inverter remains fully functional, you are advised to check for any firmware updates in the download area of the website www.abb.com/solarinverters or <https://registration.abbsolarinverters.com> (instructions for registering on the website and updating the firmware are given in this manual)

Display access and settings

Once the inverter has been commissioned, it is possible/necessary to configure the inverter by accessing the Settings Menu directly from the display. The following are the main adjustable parameters (see the section on “**Menu descriptions**”)

- **RS485 address:** setting required in the case of system monitoring via the RS485 line
- **Vstart:** setting required if requested by the configurator during the system sizing procedure (“Vstart” parameter)
- **MPPT scan:** allows maximum power point tracking with settable sensitivity and time interval (“MPPT” parameter).
- **Setting of analogue inputs (if any):** allows you to set the parameters of the analogue sensors connected to the input (“Analogue Inputs”).
 - **Input Strings (where present):** setting necessary for checking the status of the fuses and the unbalance of the string currents at the input (“Fuse control” parameter).
 - **Reactive power feed-in setting (where present):** setting necessary for managing the different ways of feeding reactive power into the grid (“Reactive Power” parameter)
 - **Active power limitation setting (where present):** setting necessary to set a limit on the active power supplied by the inverter (“Power reduction” parameter)

Updating the firmware from an SD card

The firmware can be easily updated by means of an SD Card (4GB maximum capacity)

The latest firmware version is available from the download area of the website www.abb.com/solarinverters or from <https://registration.abbsolarinverters.com>



Perform the update during good irradiation conditions (avoid the dawn and dusk hours)

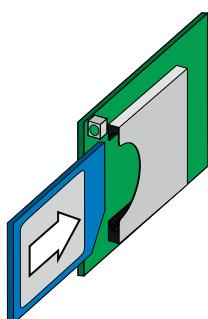

- Format the SD card with a "FAT32" File System
- Save the (.tib) update file on the SD Card. The file must not be compressed and/or nested inside folders
- Turn the inverter off by physically disconnecting the AC and DC voltages, as well as any voltages connected to the multi-function relay, then open the inverter front cover.
- Insert the SD Card in the dedicated memory card housing ⁽²⁵⁾ with the notched side facing down.
- Start the inverter
- The inverter display prompts for confirmation to launch the update

The update procedure starts automatically. Do not carry out any operation on the inverter during the update process

- Once the procedure is completed, the display shows the update results

Dynamic display behaviour

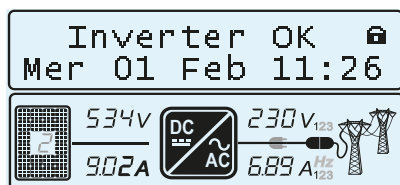

- If the MPPT scan function is enabled, icon [b09](#) will be shown on the display. See configuration in the MPPT section of the Settings menu. This icon will flash during scanning.

- During operation, the following values are displayed in rotation:
 - Voltage and current ([b15](#) and [b16](#)) from the PV generator. Depending on the configuration or model of the inverter, the voltages and currents of one or both channels will be displayed. The input channel considered is indicated by the value included in icon [b14](#).

- Voltage and current ([b19](#) and [b20](#)) in the various phases. Depending on the ACDC model of the inverter, the voltages and currents of one (1) or three phases (1,2,3) will be displayed. The phase considered is shown to the right of the voltage and current values.

At the end of the aforesaid display, the grid frequency will be indicated in field [b20](#) and the phase-to-phase voltage will be indicated in field [b19](#). At the same time, the main readings made by the inverter will be displayed in rotation on the graphic display [b10](#).

- Display of the power graph [b11](#).

The histogram allows for 16 horizontal units and 20 vertical units.

Time is represented along the horizontal axis of the graph and can be set by the user to 8, 16 or 24 hours; therefore, each horizontal unit can represent 30, 60 or 120 minutes.

Output power is represented on the vertical axis, with 100% corresponding to the maximum power that can be exported by the inverter to the grid.

Finally, bear in mind that the power value expressed by each column of the graph represents the average value of the power during the period relating to the horizontal unit.

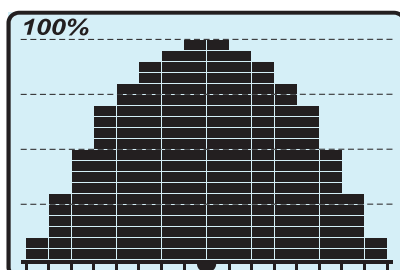

LED behaviour

- = LED On
 ⊗ = LED flashing
 ⊗ = LED Off
 ⊗ = Any one of the conditions described above

The following table shows all the possible activation combinations of LEDs on the LED panel according to the operating status of the inverter.

LED status	Operating state
green: ⊗ yellow: ⊗ red: ⊗	Firmware programming The inverter firmware is being programmed
green: ⊗ yellow: ⊗ red: ⊗	Night mode (inverter automatically switches off) The inverter is in night time switch-off mode (input voltage less than 70% of the set start-up voltage).
green: ⊗ yellow: ⊗ red: ⊗	Inverter initialisation This is a transitional state during verification of the operating conditions. During this stage the inverter checks that the conditions for connecting to the grid are met.
green: ● yellow: ⊗ red: ⊗	The inverter is connected and is feeding power into the grid Normal operation During this stage, the inverter automatically tracks and analyses the photovoltaic generator's maximum power point (MPP).
green: ⊗ yellow: ● red: ⊗	Disconnection from the grid Indicates no grid voltage. This condition does not allow the inverter to connect to the grid (the inverter display shows the message "Missing Grid").
green: ⊗ yellow: ● red: ⊗	Indication of Warning (W message codes) or Error (E message codes) states Indicates that the inverter control system has detected a warning (W) or error (E). The display shows a message indicating the type of problem found (see Alarm messages).
	<ul style="list-style-type: none"> • Ventilation anomaly Indicates an anomaly in the operation of the internal ventilation system that could limit output power at high ambient temperatures.
	<ul style="list-style-type: none"> • Failed association of internal inverter components (after replacement) Indicates that the installed wiring box (only in the event of a replacement) was already associated with another inverter and cannot be associated with the new inverter
green: ⊗ yellow: ⊗ red: ⊗	<ul style="list-style-type: none"> • Overvoltage surge arresters triggered (where fitted) Indicates that any class II overvoltage surge arresters installed on the AC or DC side have been triggered
	<ul style="list-style-type: none"> • String protection fuses triggered (where fitted) Indicates that one or more input string protection fuses that may be installed have been triggered
	<ul style="list-style-type: none"> • Autotest (for Italian grid standards only) The inverter is performing a self-test
green: ⊗ yellow: ⊗ red: ●	Anomaly in the insulation system of the photovoltaic generator Indicates that a leakage to ground from the FV generator has been detected, causing the inverter to disconnect from the grid.



Specifications on the operation of the LEDs

In correspondence to each status of the inverter indicated by the constant or intermittent lighting of the specific LED, the display ⁰¹, section b10, also shows a message identifying the operation which is being carried out or the defect/anomaly recorded (see specific chapter).

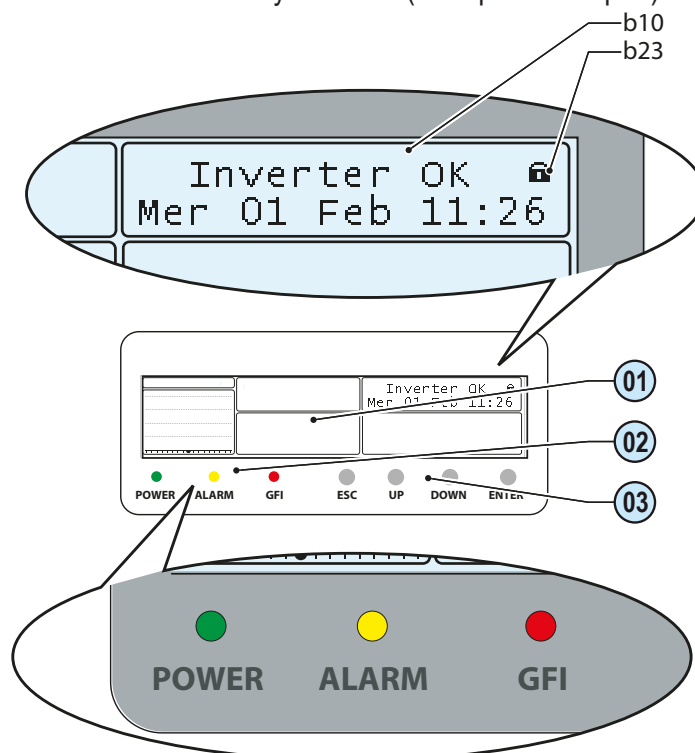

In the case of malfunction it is extremely dangerous to intervene personally to try and eliminate the defect. The instructions below must be followed scrupulously; if you do not have the necessary experience and training to intervene safely, please contact a specialist.

LED insulation fault

Interventions after warning of insulation fault

When the red LED comes on, first try to reset the warning by pressing the multi-function ESC button on the LED panel ⁰².

Should the inverter reconnect normally to the network the fault was due to temporary phenomena.

You are advised to have the plant inspected by the installer or a specialist should this malfunction occur repeatedly.

Should the inverter not reconnect to the grid, isolate it on both the AC and DC sides (by using the disconnect switches), then contact the installer or authorised centre to repair the fault in the photovoltaic generator.

Description of the menus

The display ① has a section b10 (graphic display) for moving through the menu by using the buttons ③.

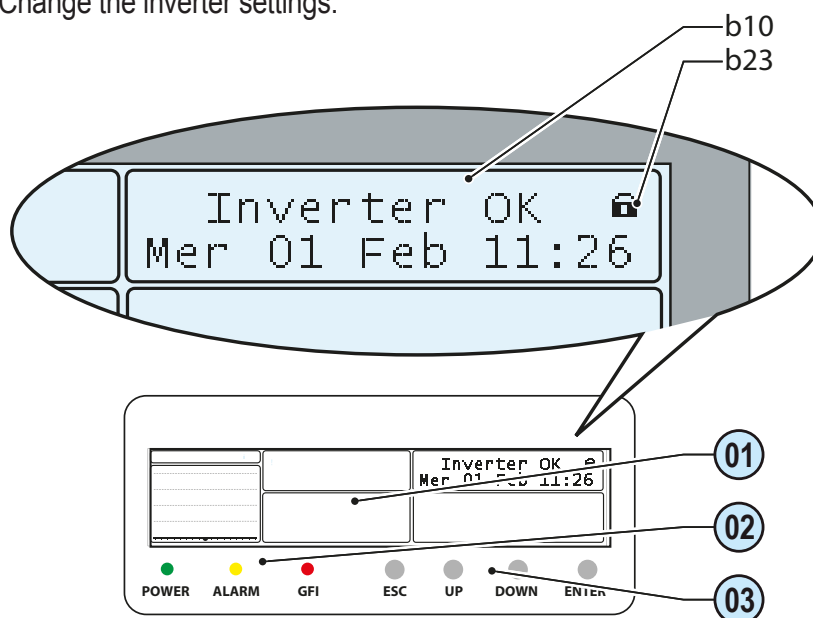

Section b10 consists of 2 lines with 16 characters per line and can be used to:

- Cycle through the general information on:
 - Operating status and error/warning code indications
 - Inverter identification details
 - Active and reactive power management settings
 - Main parameters measured;
- Display statistical data;
- Display service messages for the operator;
- Change the inverter settings.



General information

While the inverter is operating, the display shows various items of information on the main parameters measured, the operating conditions and the inverter's operating status.

The display cycles through the information when the icon b23 shows two curved arrows ; if it shows a padlock  it means that the display of information is locked and the UP and DOWN buttons can be used to scroll through the screens of information instead. You can switch between the two display modes by pressing the ENTER button.

The sequence of screens displayed is shown below, with a description of the parameters monitored.

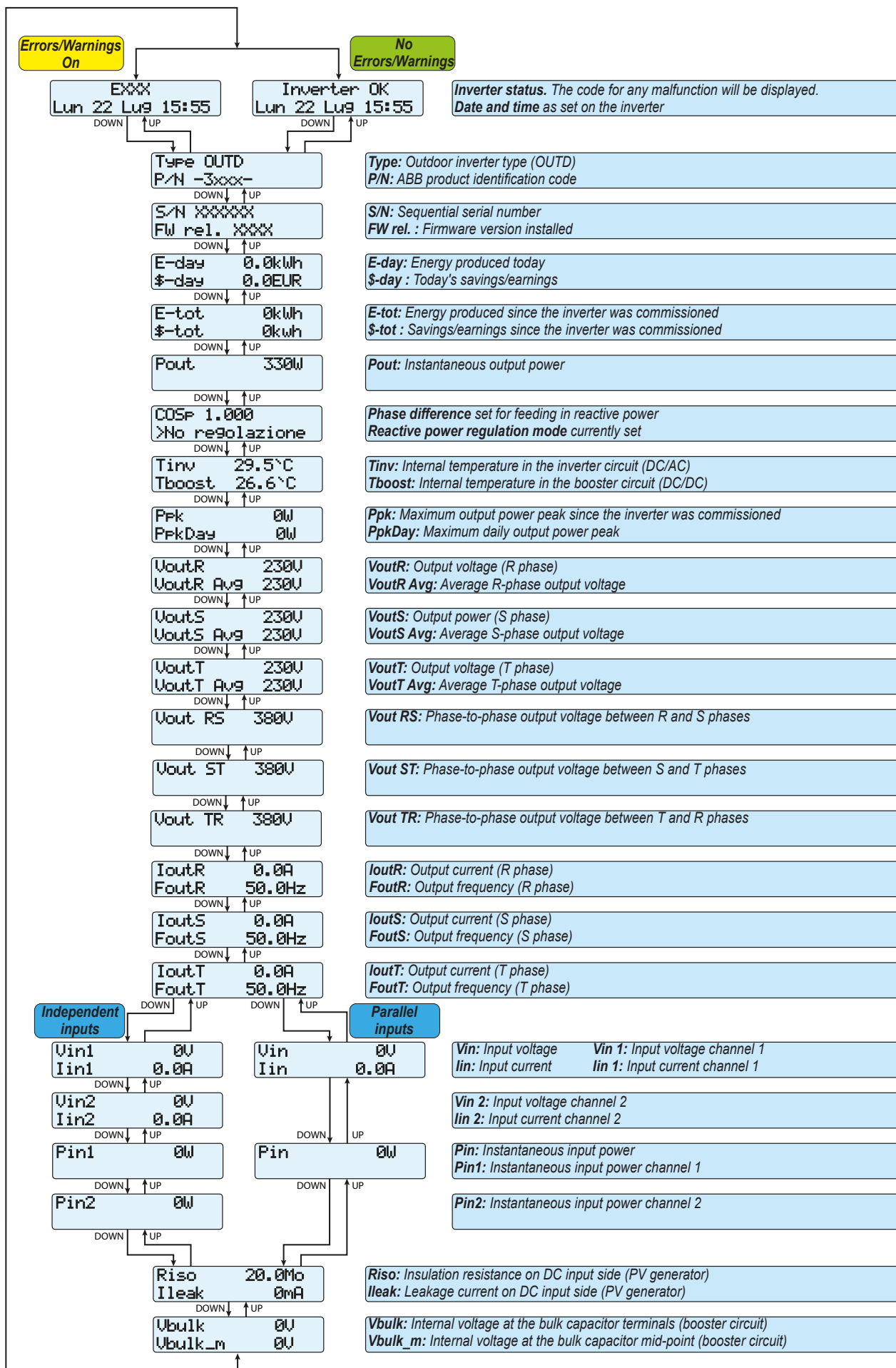

Statistics Menu

Selecting STATISTICS from the three main sub-menus gives access to:

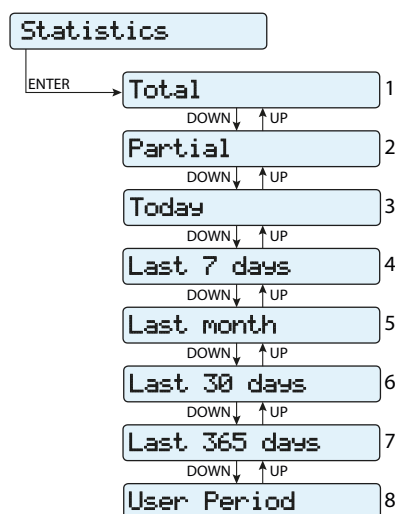

1. Total

This section of the menu displays the Total statistics:

- **Time:** Total operating time
- **E-tot:** Total energy produced
- **Val. :** Total production value, calculated using the currency and conversion coefficient set in the relevant section of the SETTINGS menu
- **CO₂:** Amount of CO₂ saved compared to fossil fuels

2. Partial

This section of the menu displays the Partial statistics:

- **Time:** Partial operating time
- **E-par:** Partial energy produced
- **PPeak:** Peak power value
- **Val. :** Partial production value, calculated using the currency and conversion coefficient set in the relevant section of the SETTINGS menu
- **CO₂:** Partial amount of CO₂ saved



To reset all the counters of this sub-menu, press the ENTER button for more than 3 seconds. At the end of this time, you will hear a sound repeated 3 times.

3. Today

This section of the menu displays today's statistics:

- **E-day:** Energy produced today
- **Ppeak:** Today's peak power value
- **Val. :** Value of today's production, calculated using the currency and conversion coefficient set in the relevant section of the SETTINGS menu
- **CO₂:** Amount of CO₂ saved today

4. Last 7 days

This section of the menu displays the statistics for the last 7 days:

- **E-7d:** Energy produced over the last 7 days
- **Val. :** Value of production over the last 7 days, calculated using the currency and conversion coefficient set in the relevant section of the SETTINGS menu
- **CO₂:** Amount of CO₂ saved over the last 7 days

5. Last month

This section of the menu displays the statistics for the last month:

- **E-mon:** Energy produced during the current month
- **Val. :** Value of the last month's production, calculated using the currency and conversion coefficient set in the relevant section of the SETTINGS menu
- **CO₂:** Amount of CO₂ saved during the current month

6. Last 30 days

This section of the menu displays the statistics for the last 30 days:

- **E-30d:** Energy produced over the last 30 days
- **Val. :** Value of production over the last 30 days, calculated using the currency and conversion coefficient set in the relevant section of the SETTINGS menu
- **CO₂:** Amount of CO₂ saved over the last 30 days

7. Last 365 days

This section of the menu displays the statistics for the last 365 days:

- **E-365:** Energy produced over the last 365 days
- **Val. :** Value of production over the last 365 days, calculated using the currency and conversion coefficient set in the relevant section of the SETTINGS menu
- **CO₂:** Amount of CO₂ saved over the last 365 days

8. User period

This section of the menu displays the statistics for a period chosen by the user:

Once the start and end dates for the period have been set, the following data are available:

- **E:** Energy produced over the selected period
- **Val. :** Value of production over the selected period, calculated using the currency and conversion coefficient set in the relevant section of the SETTINGS menu
- **CO₂:** Amount of CO₂ saved over the selected period



Settings Menu

Selecting STATISTICS from the three main sub-menus brings up the first screen, asking for the password.

The default password is "0000".

This can be changed by using the display buttons, following the same procedure as always:

- ENTER scrolls through the digits (from left to right)
- ESC returns to the previous digit (from right to left)
- Press ESC several times to return to the previous menus
- DOWN scrolls down the numerical scale (from 9 to 0)
- UP scrolls up the numerical scale (from 0 to 9)

After entering the password, press ENTER to access the information in this section:

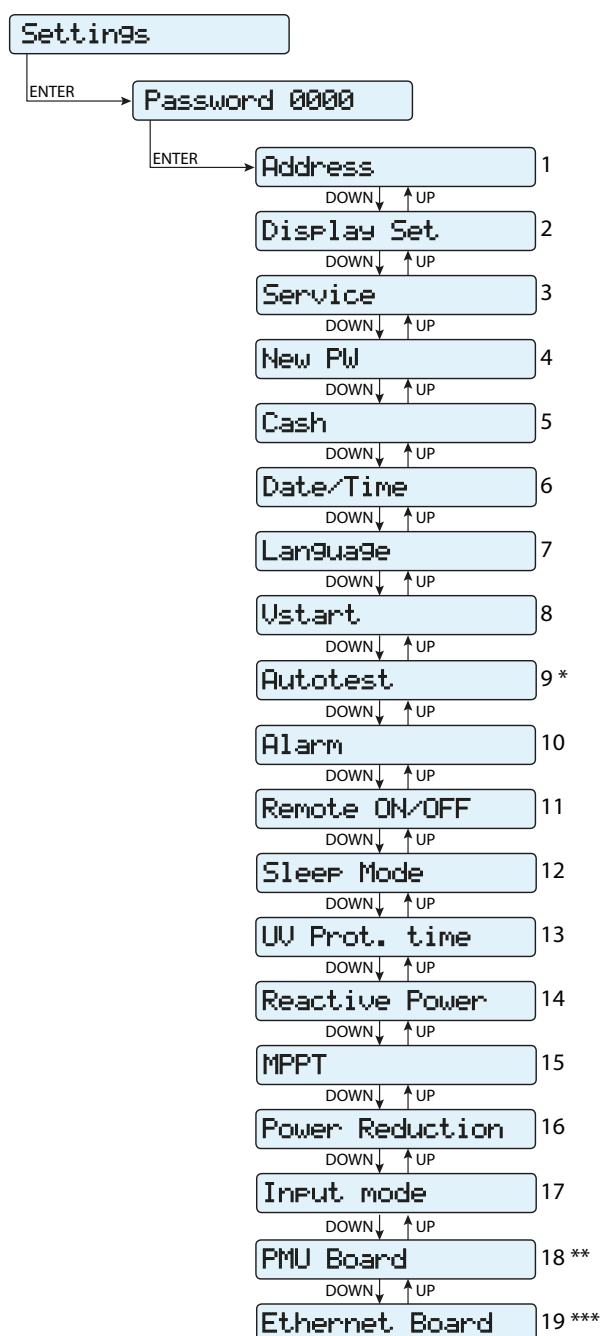

(*) Available for the Italian country standard only. Refer to the section on this topic in the manual.

(**) Available only when the accessory PMU Expansion Board is installed

(***) Available only when the accessory Ethernet Expansion Board is installed

1. Address

This section of the menu allows you to set the serial port addresses of the individual inverters connected to the RS485 line.

The addresses that can be assigned are 2 to 63. The UP and DOWN buttons scroll through the numerical scale.

'AUTO' selection cannot be used at present.

2. Display Set

This section of the menu allows you to set the display properties:

- **Light:** sets the lighting mode and adjusts the display backlight

Mode:

ON: Light always on

OFF: Light always off

Auto: Automatic backlight control. The light is switched on whenever a button is pressed and stays on for 30 sec, after which it gradually dims out.

Intensity: adjusts display brightness (scale from 1 to 9)

- **Contrast:** adjusts display contrast (scale from 1 to 9)

- **Buzzer:** sets button sound

ON: button sound is on

OFF: button sound is off

3. Service

This section of the menu is reserved for installers.

A special access password is required, which may be obtained from the website <https://registration.abbsolarinverters.com>

Before connecting to the site, make sure you have all the information required to calculate your password:

Inverter Model, Serial Number, week of manufacture and Update field

When you have a password you can set the parameters in the menu.

Changing the above-mentioned parameters may prevent disconnection from the grid if the new values exceed those given in the standards of the country of installation. If these parameters are changed to values outside the standard range, an interface protection must be installed external to the inverter in accordance with the requirements of the country of installation.



The table below shows the parameters that can be changed and the range of values that may be set for each:

Parameter	Description	Setting range
Set U>>	Grid over-voltage (OV) threshold (extended range)	Unom ... Unom x 1.3
Set U<<	Grid under-voltage (UV) threshold (extended range)	10V ... Unom
Set F>>	Grid over-frequency (OF) threshold (extended range)	Fnom ... Fnom + 5Hz
Set F<<	Grid under-frequency (UF) threshold (extended range)	Fnom - 5Hz ... Fnom
Set U>	Grid over-voltage (OV) threshold (restricted range)	Unom ... Unom x 1.3
Set U> (10Min)	Grid over-voltage (OV) threshold (average grid voltage value)	Unom ... Unom x 1.3
Set U<	Grid under-voltage (UV) threshold (restricted range)	10V ... Unom
Set F>	Grid over-frequency (OF) threshold (restricted range)	Fnom ... Fnom + 5Hz
Set F<	Grid under-frequency (UF) threshold (restricted range)	Fnom - 5Hz ... Fnom

Parameter	Description	Setting range	
Set Uconn>	Max. permissible voltage during checks prior to grid connection	Unom ... Unom x 1.3	
Set Uconn<	Min. permissible voltage during checks prior to grid connection	10V ... Unom	
Set Fconn>	Max. permissible frequency during checks prior to grid connection	Fnom ... Fnom + 5Hz	
Set Fconn<	Min. permissible frequency during checks prior to grid connection	Fnom - 5Hz ... Fnom	
Set Time U>>	Over-voltage U>> protection tripping time	0 ... 327670mS	
Set Time U<<	Under-voltage U<< protection tripping time		
Set Time F>>	Over-frequency F>> protection tripping time		
Set Time F<<	Under-frequency F<< protection tripping time		
Set Time U>	Over-voltage U> protection tripping time		
Set Time U<	Under-voltage U< protection tripping time		
Set Time F>	Over-frequency F> protection tripping time		
Set Time F<	Under-frequency F< protection tripping time		
Set time conn 1	Grid check time prior to connection		0 ... 65535mS
Set time conn 2	Grid check time prior to connection after a grid fault		
Disable U>>	Disables the U>> protection threshold	Enabled/Disabled	
Disable U<<	Disables the U<< protection threshold		
Disable F>>	Disables the F>> protection threshold		
Disable F<<	Disables the F<< protection threshold		
Disable U>	Disables the U> protection threshold		
Disable U> (10Min)	Disables the U> (10Min) protection threshold		
Disable U<	Disables the U< protection threshold		
Disable F>	Disables the F> protection threshold		
Disable F<	Disables the F< protection threshold		
U> (10Min) Der.	Enables power derating mode due to high average grid voltage readings		0 Derating disabled 1 BDEW derating 2 VDE-AR-N derating 3 CEI derating
Slow Ramp	Enables gradual ramping up of power after the grid connection.		
OF Derating	Selects the power derating mode in the event of grid over-frequency.	1 ... 1000S	
OF Der. Rest. T	Time period after OF derating in which the inverter checks that the frequency is back within the operating ranges (parameters Fconn< and Fconn>) required by the grid standard before ramping up the output from the derating condition		
Amorph. Enable	Enables Amorphous Mode in the event that the negative input pole is grounded by installing the Negative Grounding Kit (not available)	Enabled/Disabled	
Reset Country S.	Unlocks the grid standard selection (resets the 24 hours available for changing the grid standard)	Reset	
Upgrade IP Addr	Allows manual setting of the Ethernet board IP address This function may be useful where static Ethernet board addresses are used (DHCP disabled)	xxx.xxx.xxx.xxx	



4. New PW

This section of the menu allows you to change the settings menu password (default 0000).

We advise you to memorize the new password with great care.

If the Password is lost you will not have access to the inverter, since there is no Reset function for security reasons

5. Cash

This section of the menu allows you to set the name of the currency and the value of 1 kWh of energy produced. Setting these parameters correctly allows the actual earnings/savings achieved by the system to be displayed.

- **Nome:** sets the desired currency (default is Euro)
- **Val/KWh:** indicates the cost/incentive for 1 kWh in the chosen currency (default is 0.50).

6. Date/Time

Allows you to set the current date and time (not counting summer time)

7. Language

Allows you to set the language you prefer for the menus

8. Vstart

This section of the menu allows you to set the Vstart voltage (for the two channels separately if they are configured independently) to suit the system requirements.

We advise changing the activation voltage only if really necessary and to set it to the correct value: the photovoltaic generator sizing tool available on the ABB website will indicate whether Vstart needs changing and what value to set it at.

9. Autotest

This section of the menu is available only for the Italian country standard. Refer to the section on this topic in the manual.

10. Alarm

This section of the menu allows you to set the activation status of a relay (available either as contact normally open – N.O. – or as contact normally closed – N.C.).

This contact can be used, for example, to: activate a siren or a visual alarm, control the disconnect device of an external transformer, or control an external device.

The relay can be set to switch in 4 different modes:

• Production (display text “PRODUCTION”)

The relay is activated (state: switched) whenever the inverter connects to the grid; as soon as the inverter is disconnected from the network (for whatever reason that caused disconnection), the relay is in its resting position

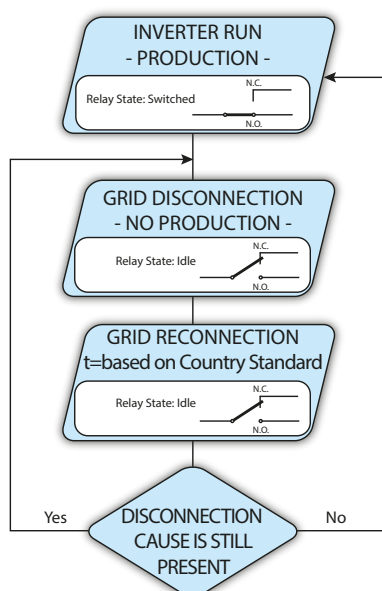

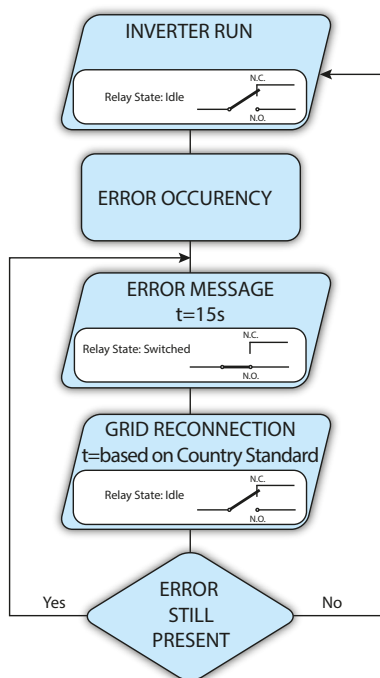

• **Alarm with reset at the end of the alarm signalling process (display text “ALARM”):**

The relay is activated (state: switched) whenever an error is present (code Exxx) on the inverter; this does not apply to warnings (Warning – code Wxxx). The alarm returns to its resting position when the alarm signal ends, i.e. before the inverter checks the grid parameters after the alarm state. This is because grid control state is not an alarm state but a state of normal operation.

Alarms for which the relay is activated

E001	E002	E003	E004	E005	E006
E007	E010	E011	E012	E013	E014
E015	E016	E017	E018	E019	E020
E021	E022	E023	E026	E029	E030
E031	E032	E033	E034	E046	E049
E050	E051	E053	E054	E055	E056
E057	E058	W003			

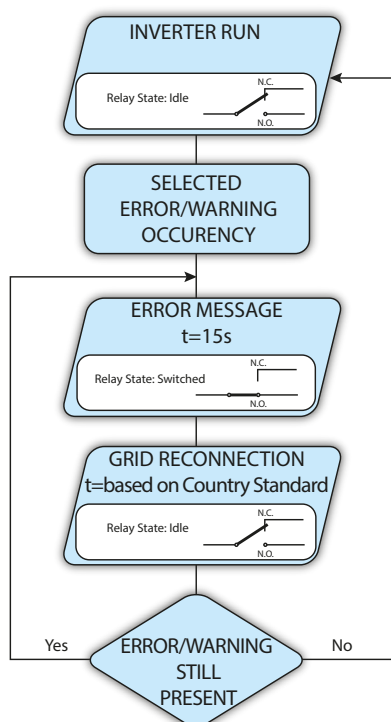

• **Configurable alarm with reset at the end of the alarm signalling process (display text “Alarm Conf.”)**

The relay is activated (state: switched) whenever an error is present (code Exxx) or a warning (code Wxxx) from those selected from the list in the dedicated submenu. The contact returns to its resting position when the alarm signal ends, i.e. before the inverter checks the grid after the alarm state. This is because grid control state is not an alarm state but a state of normal operation.

Selectable alarms for which the relay is activated

E001	E002	E003	E004	E005	E006
E007	E010	E011	E013	E014	E015
E017	E018	E019	E020	E021	E022
E023	E026	E027	E028	E029	E030
E031	E032	E033	E034	E046	E050
E051	E053	E054	E055	E056	E057
E058	W001	W002	W003	W008	W009
W011	W017	W018	W019	W021	W022
W023	W024	W025	W026	Ground fault	

For both configurable relay operating modes “ALARM” and “ALA”. CONF.” the following considerations apply:

If the alarm condition is persistent, the alarm contact cyclically switches from its resting state to its activated state.

In the presence of W003 signalling (Grid Fail – Network parameters out of tolerance), the alarm contact switches to then reset itself at the end of the alarm signal. This means that during the absence of grid voltage (display message “Vac Absent”) the alarm contact remains in its resting position.

In the presence of W002 signalling (UV Input – input voltage below the limit of operation), the alarm contact switches to then reset itself at the end of the alarm signal. This means that during the reduced input voltage (display message “Waiting sun”) the alarm contact remains in its resting position.

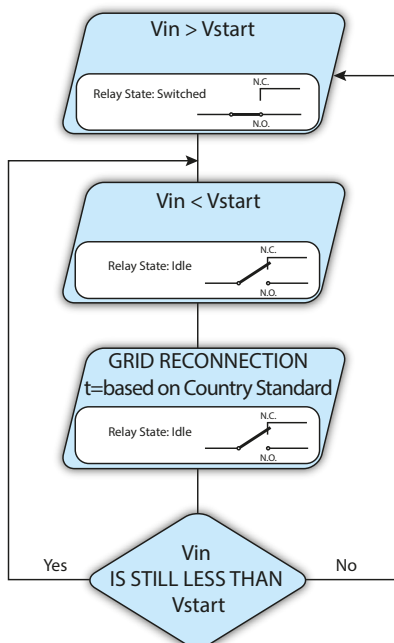

• Crepuscular (display text “CREPUSCULAR”)

The relay is activated (state: switched) as soon as the inverter input voltage exceeds the activation voltage set.

The relay is in its rest position when the input voltage drops below 70% of the activation voltage set.

This mode is useful for disconnecting any output transformers that could have unnecessary consumption during the night.

11. Remote ON/OFF

This section of the menu allows you to enable/disable the connection/disconnection of the inverter to/from the grid through the relevant control signal (R ON/OFF).

- **Disable:** the connection/disconnection of the inverter to/from the grid is dictated by the input (voltage from the photovoltaic generator) and output (grid voltage) parameters of the inverter.

- **Enable:** the connection/disconnection of the inverter to/from the grid is dictated by the state of the R ON/OFF signal compared to the GND signal, as well as by the input (voltage from the photovoltaic generator) and output (grid voltage) parameters of the inverter.

12. Sleep Mode

This section of the menu allows you to enable/disable SLEEP mode. This feature allows the inverter logic to remain active overnight, thereby also keeping active any accessory boards installed in the inverter, so that, for example, the system monitoring data may be checked (via an Ethernet board) or the reactive power fed in may be managed (via a PMU board).

13. UV Prot. Time

This section of the menu allows you to set the time for which the inverter stays connected to the grid after the input voltage has dropped below the Under Voltage limit (set at 70% of Vstart). ABB sets the time at 60 sec. The user can set it at any time from 1 to 3600 sec.

Example: with UV Prot. Time set at 60 seconds, if voltage V_{in} drops below 70% of Vstart at 9:00, the inverter stays connected to the grid (taking power from it) until 9:01.

14. Reactive power

This section of the menu may be used to manage the supply of reactive power into the grid. There are 5 possible types of management:

- **No regulation:** no regulation of reactive power. To enable this mode, select **Enable** and then **OK** (using the UP / DOWN arrows)
- **Cos-phi fixed:** Sets the power rating to a fixed value. To enable this mode, select **Enable** and then **OK** (using the UP / DOWN arrows) When enabled, **Set value** will appear on the display, allowing you to set the value of Cos-Phi (as either Over or Under excited, from 1.000 to 0.800)
- **Q fixed:** Sets the reactive power rating to a fixed value. To enable this mode, select **Enable** and then **OK** (using the UP / DOWN arrows) When enabled, **Set value** will appear on the display, allowing you to set the value of reactive power rating (as either Over or Under excited, from 1.000 to 0.001).
- **Cos-phi = f(P):** Power rating as a function of the active power supplied by the inverter. To enable this mode, select **Enable** and then **OK** (using the UP / DOWN arrows). When it has been enabled, **Load std curve** will appear on the display, allowing you to set the following control curve:

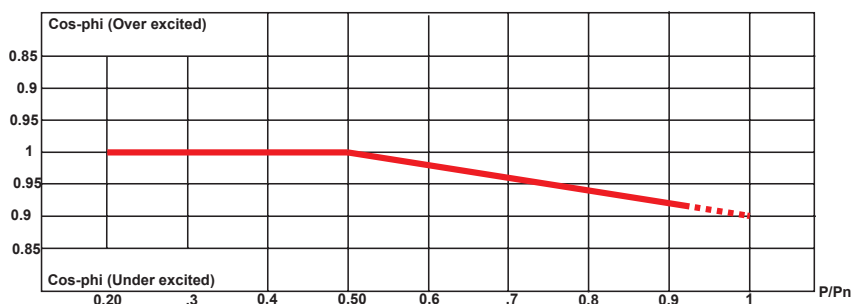

(*) The curve can be edited with the Aurora Manager LITE configuration software

- **Q = f(U):** reactive power as a function of the grid voltage measured by the inverter. To enable this mode, select **Enable** and then **OK** (using the UP / DOWN arrows). When it has been enabled, **Load std curve** will appear on the display, allowing you to set the following control curve(*):

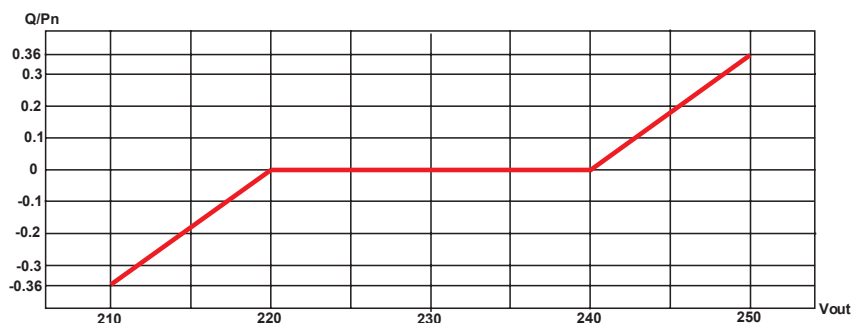

(*) The curve can be edited with the Aurora Manager LITE configuration software

15. MPPT

This section of the menu allows you to set the parameters of the maximum power point tracking (MPPT) function. This function is useful when there are areas of shade on the PV generator, which may create several points of maximum power on the operating curve.

- **MPPT Amplitude:** by setting this parameter you can choose the amplitude of the DC perturbation introduced to establish the optimal operating point. There are 3 settings to choose from (LOW, MEDIUM, HIGH). The default setting is MEDIUM.

- **Multi-max scan:** by setting this parameter, you can enable/disable the scan, decide the frequency with which the scan is carried out and override it manually.

Enable/Disable: Enables/disables the scan for identifying the maximum power point of the system.

- **Scan Interval:** this allows you to set the time between scans. It should be borne in mind that the shorter the scan interval the greater the loss of production, due to the fact that energy is transferred to the grid during the scan but not at the maximum power point. Each scan takes roughly 2 seconds.

- **Manual Scan:** this allows you to start a manual scan of the photovoltaic generator (at a different time from the interval set in Scan Interval) in order to track the maximum power point.

16. Power reduction

This section of the menu allows you to adjust the limit to the active power that the inverter can feed into the grid by setting the percentage of nominal power at which the limit should be triggered.

Setting it to 100% resets the default maximum power, which in some installation country standards may be 110% of nominal power.

17. Input Mode

This section of the menu allows you to set the input configuration mode:

- **Independent:** Where the two input channels are used separately for connecting the strings
- **Parallel:** Where the input channels are connected in parallel to provide a single input channel



In both cases make sure that the conditions for configuring the input channels described in this manual are met

18. PMU Board

This section of the menu allows you to adjust the settings for the accessory PMU Expansion Board:

- **RS485 Slave:** Sets the communication protocol (Aurora or ModBus) for the RS485 S (Slave) serial communication line
- **PMU Mode:** Sets the active and reactive power management mode (PMU – Power Management Unit)
- **Analogue inputs:** Configures the individual analogue inputs

19. Ethernet Board

This section of the menu allows you to adjust the settings for the accessory Ethernet Expansion Board:

- **DHCP:** Enables/disables dynamic address allocation for the Ethernet board.



If DHCP is disabled, the Ethernet board IP address must be set manually ("IP Address" section).

- **Address IP:** Sets the Ethernet board IP address
- **Gateway:** Sets the IP address of the gateway receiving data from the monitored system.
- **Netmask:** Sets the Internet subnet mask.
- **Primary DNS:** Sets the Internet primary DNS.
- **Secondary DNS:** Sets the Internet secondary DNS.
- **Portal IP add.:** Sets the Aurora Vision portal IP address.
- **AV Method:** Enables/disables data transmission to the Aurora Vision Plant Viewer/Aurora Vision®.
- **Data to portal:** Enables/disables data transmission to the ABB portal.
- **Send events:** Enables/disables the sending of events (error codes) to the portal.
- **Check Updates:** Enables/disables checking for Ethernet expansion board firmware updates.
- **Data send time:** Sets the time for the data transmission to the portal (not available in the current product version). The default value is 900 seconds.



Info Menu

Selecting INFO from the three main sub-menus gives access to:

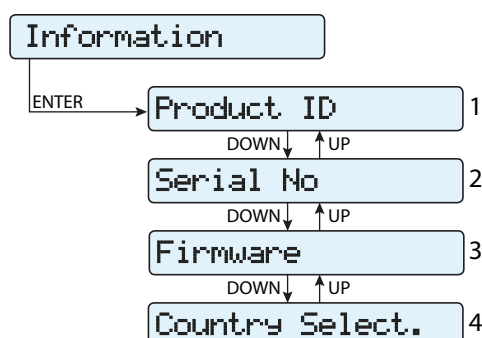

1. Product ID

Displays the model code

2. Serial No

Displays the serial number and week and year of manufacture of the equipment

3. Firmware

Displays the firmware version installed in the equipment and the “update version” field required to request a second-level password for the Service menu (along with the Serial Number and Week of Production).

4. Country Select.

Displays information on the grid standard set with the rotary switches.

- **Actual value:** Displays the grid standard set.
- **New value:** Allows you to select a new grid standard (by using the UP and DOWN buttons), which will only become effective when the equipment has been switched off and on again, or when the selection has been confirmed in the Set new value submenu described below.
The grid standard can only be changed if the time allowed for doing so (24 hours of operation) has not expired.
- **Set new value:** This allows you to confirm/set the new grid standard set in the “New value” section of the previous menu.
- **Residual time:** Displays the time remaining in which it is still possible to set a new grid standard. When the time expires, “Locked” will be displayed, which indicates it is not possible to change the grid standard again.



AUTOTEST procedure in accordance with standard CEI 0-21

The autotest run in accordance with grid standard **CEI-021** may be initiated from the display menu or by using an RS485/USB converter with the dedicated interface software (Aurora Communicator).

The conditions required to perform an Autotest are:

- The grid standard must be set to CEI-021.
- You must not intervene in any way while the test is underway
- You must check that the device has a stable network connection.

Running the tests from the display menu

In the Autotest section of the SETTINGS menu, select the type of test the device is to run from the following:

OV Test – parameters:

U>>R, U>>S, U>>T; U>R, U>S, U>T;

U> (10Min)R, U> (10Min)S, U> (10Min)T

Disconnection from the distribution grid due to “Over-voltage”

UV Test – parameters:

U<<R, U<<S, U<<T: U<R, U<S, U<T

Disconnection from the distribution grid due to “Under-voltage”

OF Test – parameters:

F>> and F>

Disconnection from the distribution grid due to “Over-frequency”

UF Test – parameters:

F<< and F<

Disconnection from the distribution grid due to “Under-frequency”

Go to the SETTINGS > Autotest menu

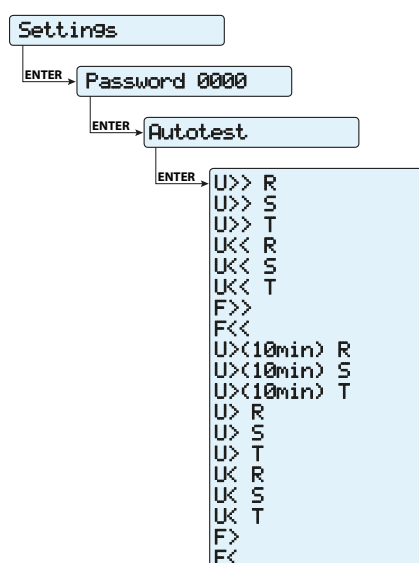

Various signs may be displayed alongside the parameters on which the autotest can be performed. These have the following meanings:

N/A - Test cannot be performed because the relevant parameter is not active

Idle - Test enabled but not yet performed

OK - Test enabled and performed successfully

If one of the protections is disabled (from the Service menu), N/A (not applicable) will appear next to the name of the test.

While one of the tests is being performed, the set limits will be gradually increased/reduced (depending on the type of test) until the threshold at which the inverter is disconnected from the grid is reached. The procedures for running the Autotest comply with the legislation in force.

```
Test in corso
*****
```

The display shows the message “Performing Test” when the test has started.

At the end of the test, when the inverter has disconnected from the grid, the results and values of the test performed will appear on the display. You can move from one screen to another using the UP/DOWN arrow keys.

Details of the data available in each screen are provided below:

Screen 1 of 3

```
123456 XXX 1/3
Test: OK
```

Inverter serial number

Parameter tested (e.g. U>>)

Screen number

Test result

Screen 2 of 3

```
123456 XXX 2/3
YYY Y      ZZZZ7
```

Inverter serial number

Parameter tested (e.g. U>>)

Screen number

Value of the grid parameter detected when the protection was tripped

Measured protection tripping time

Screen 3 of 3

```
123456 XXX 3/3
YYY Y      ZZZZ7
```

Inverter serial number

Parameter tested (e.g. U>>)

Screen number

Protection tripping value

Set protection tripping time

The test results should be considered valid on the basis of the following tolerances, as reported in the applicable legislation:

- $\leq 5\%$ for voltage thresholds
- ± 20 mHz for frequency thresholds
- $\leq 3\% \pm 20$ ms for tripping times

Press ESC to go back to the Autotest menu, from where you may select the next test to be performed

Inverter switch-off



Some parts may be very hot and could cause burns.



Some inverter parts may be subject to voltages that could be hazardous for the operator. Before performing any work on the inverter, follow the procedure for turning off the inverter.

The figures on the left show the areas subject to voltage inside the inverter

- **Red:** areas subject to input voltage (DC)
- **Orange:** areas subject to output voltage (AC)
- **Green:** areas subject to low voltage (SELV)

- Disconnect any power supplies that may be connected to the configurable relay.

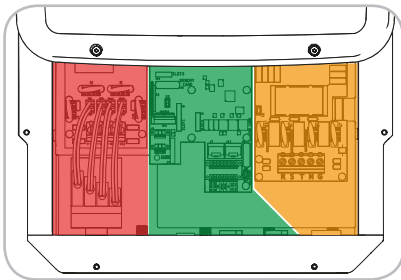

- The figure on the left shows the areas subject to voltage in the inverter under normal operating conditions.

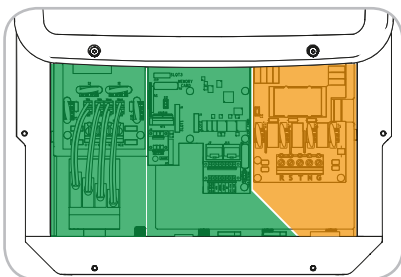

- Open the DC disconnect switch on the outside of the inverter.

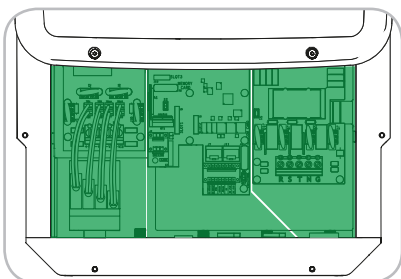

- Disconnect the grid voltage (by switching off the protective device upstream of the inverter).

Under these conditions the inverter does not have any hazardous voltages and all areas may be freely accessed.



Before attempting any work on the inverter, wait enough time for the stored energy to be discharged



Maintenance

8

General conditions

Checking and maintenance operations must be carried out by specialized staff assigned to carry out this work.



Maintenance operations must be performed with the apparatus disconnected from the grid (power switch open) and the photovoltaic panels obscured or isolated, unless otherwise indicated.



*For cleaning, DO NOT use rags made of filamentary material or corrosive products that may corrode parts of the equipment or generate electrostatic charges.
Avoid temporary repairs. All repairs should be carried out using only genuine spare parts.
The maintenance technician is under an obligation to promptly report any anomalies.*

DO NOT allow the equipment to be used if problems of any kind are found, and restore the normal conditions correctly or otherwise make sure that this is done.



Always use the personal protective equipment provided by the employer and comply with the safety conditions of the Accident prevention chapter.

Routine maintenance



Scheduled maintenance operations are not mandatory, but are recommended to preserve the efficiency of the PV plant.



We recommend that maintenance operations be carried out by qualified personnel or by the personnel of ABB (as set forth in a maintenance contract).

The periodicity of the maintenance operations may vary in accordance with local environmental conditions and the installation

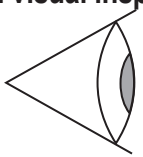
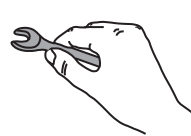
Table: routine maintenance

<p>Annual visual inspection</p> 	<ul style="list-style-type: none"> • Check that the inverter is operating correctly, and that no fault alarms are present • Ensure all the labels and safety symbols are visible • Test the integrity of the cables, connectors, and plugs external to the inverter • Check that the environmental conditions have not changed drastically since the installation of the system
<p>Annual operations</p> 	<ul style="list-style-type: none"> • Check that cable glands and connection block screws are tight • Check that the wiring box cover is properly closed • If no monitoring system is present, check the history log of alarms and errors using the instructions given in the manual in order to look for recent malfunction warnings
<p>Annual cleaning</p> 	<ul style="list-style-type: none"> • Clean the equipment; in particular the bottom grille of the wiring box and the heat sink

Troubleshooting

Follow the table shown in the following paragraph in order to understand and resolve warning (Wxxx) and error (Exxx) messages displayed by the inverter



The operations carried out on the inverter in order to identify and resolve malfunctions may be carried out only by the organization that carried out the installation or by qualified personnel



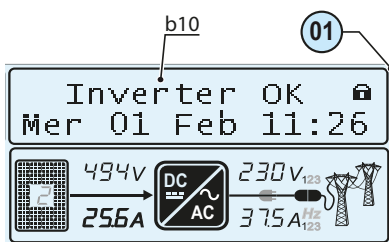







Alarm Messages













The equipment is able to indicate errors/warnings on the display only if the input voltage is higher than the V_{dcmin} voltage (POWER LED flashing or on; see operation chapter).

The messages and their codes are indicated on the highlighted part **b10** of the display **01**.

The following table gives the complete list of errors/warnings relating to string inverters. Some error/warning codes may not be used depending on the inverter model installed.

- Code on display - Error message - Signal	Name of Alarm and Cause	Solution
<ul style="list-style-type: none"> - No code - Ground F -  Red LED 	<p>Ground fault of photovoltaic generator: The alarm is generated when a leakage current to ground is detected in the DC section of the system.</p>	<ul style="list-style-type: none"> • Measure the insulation resistance using a megohmmeter positioned in the photovoltaic field (positive terminal short-circuited at the negative pole) compared to ground. The measurement is strongly influenced by the environmental conditions, so must be taken under the same conditions in which the error occurred. - If the value measured is lower than 1 megaohm, a check must be carried out by a technician/installer on the photovoltaic generator to identify and eliminate the problem. - If the value measured is higher than 1 megaohm and the error signal persists, contact customer assistance.
<ul style="list-style-type: none"> - No code - NEW COMPONENT REFUSED! -  Yellow LED lamp. 	<p>Lack of linkage of the new component: The components inside the inverter (e.g. display, fuse board, communication and control board, etc.) are not inter-linked. This occurs following the replacement of one of the components inside the inverter.</p>	<ul style="list-style-type: none"> • Link the components inside the inverter by accessing the "Settings > Service > Accept boards" (refer to the procedure given in this manual). - If the signal persists also following the linking of the components, contact customer assistance.
<ul style="list-style-type: none"> - No code - SET COUNTRY or NO NATION -  No LED 	<p>SET COUNTRY or NO NATION: Indicates that in the installation phase the grid standard was not set on the inverter.</p>	<ul style="list-style-type: none"> • Set the grid standard of the country of installation following the instructions given in this manual for the inverter. - If the signal persists also following setting the grid standard, contact customer assistance.
<ul style="list-style-type: none"> - No code - Vac absent -  Yellow LED 	<p>Vac absent: The inverter displays the "Vac absent" message when it does not record output voltage (AC side).</p>	<ul style="list-style-type: none"> • Check the grid voltage on the inverter's AC terminal block. - Should it be absent, check any protection work on the line and the presence of grid voltage on the supply point.
<ul style="list-style-type: none"> - No code - Mem. broken -  Yellow LED 	<p>Memory broken: The inverter displays the "Memory broken" message when it records a communication problem with the memory board on which the inverter saves the daily value of energy produced.</p>	<ul style="list-style-type: none"> • Remove the memory board and check the welding of all the connector's terminals. Subsequently reinsert the memory board and check that it is correctly inserted into the dedicated slot - If the signal persists also following the above checks, contact customer assistance.
<ul style="list-style-type: none"> - No code - Awaiting sun -  Green LED lamp. 	<p>Awaiting sun: The inverter displays the "awaiting sun" message when, following a W001 and/or W002 notice, the voltage from the photovoltaic generator is less than the activation voltage (Vstart).</p>	<ul style="list-style-type: none"> • Check the input voltage on the inverter. - If it does not exceed Vstart, check for the presence of sufficient irradiation and the correct composition of the system. - If it exceeds Vstart, contact customer assistance
<ul style="list-style-type: none"> - W001 - Sun Low -  Yellow LED 	<p>Insufficient irradiation (Low input voltage on switching on the inverter): Incorrect configuration of the PV generator or an "on the limit" configuration for the inverter's minimum input voltage.</p>	<ul style="list-style-type: none"> • Check the input voltage on the inverter. - If it does not exceed Vstart, check for the presence of sufficient irradiation and the correct composition of the system. - If it exceeds Vstart, contact customer assistance
<ul style="list-style-type: none"> - W002 - Input UV -  Yellow LED 	<p>Insufficient irradiation (Low input voltage on switching off): Incorrect configuration of the photovoltaic generator or an "on the limit" configuration for the inverter's minimum input voltage.</p>	<ul style="list-style-type: none"> • Check the input voltage on the inverter. - If it does not exceed Vstart, check for the presence of sufficient irradiation and the correct composition of the system. - If it exceeds Vstart, contact customer assistance
<ul style="list-style-type: none"> - W003 - Grid Fail -  Yellow LED 	<p>Parameters of grid voltage outside range: This error signal occurs when during the inverter's normal operation the grid parameters exceed the limits set by the operator: - Grid voltage absent (after the signal the inverter goes to "Vac Absent") - Unstable grid voltage (down or up) Unstable grid frequency</p>	<ul style="list-style-type: none"> • Check the grid voltage on the inverter. - Should it be absent, check for absence of grid voltage on the supply point. - If, on the other hand, the voltage tends to rise (when the inverter is connected) there is high line or grid impedance. • Check the grid voltage also on the supply. - If it is high, it means that there is high grid impedance. In this case, ask the operator to adjust the grid voltage. If the operator authorises a change to the inverter's parameters, agree the new limits with customer assistance - If the voltage at the point of supply is much lower than that measured on the inverter, it is necessary to adjust the line (inverter-contactor). - If the voltage and the grid frequency come back within the limits (also when the inverter is connected to the grid) contact customer assistance
<ul style="list-style-type: none"> - W009 - Empty Table -  Yellow LED 	<p>Characterisation board for the wind generator not compiled (only WIND models)</p>	<p>(only WIND models)</p>



- Code on display - Error message - Signal	Name of Alarm and Cause	Solution
- W010 * - Fan broken! -  Yellow LED lamp. *not visualised on display	Fan broken: This error occurs when there is a malfunction in the fan/fans inside the inverter.	<ul style="list-style-type: none"> • Error inside the inverter and cannot be checked externally. - If the alarm repeats persistently, contact customer assistance.
- W011 - Bulk UV - 	Bulk Under-voltage: The alarm (which is a warning and not an error) is generated when the voltage at the heads of the bulk capacitors does not reach the threshold for the operation of the inverter (internal unchangeable threshold).	<ul style="list-style-type: none"> • Raise the value of the activation voltage (Vstart) so as to have sufficient power from the PV generator at the time of the inverter's grid connection. • Check the input voltage on the inverter. - If it does not exceed Vstart, check for the presence of sufficient irradiation and the correct composition of the system. - If it exceeds Vstart, contact customer assistance
- W012 * - Batt. Flat -  *not visualised on display	Battery flat: The inverter displays the "Battery flat" message when it records a voltage for the buffer battery which is too low.	<ul style="list-style-type: none"> • Check that the date/time are set correctly and, if they are not, set them. Subsequently arrange to completely switch off the inverter (on both AC and DC) and wait a few minutes. Finally, restart the inverter and check whether the date/time are now correctly set or whether they have reset to 01/01/2000. In this case replace the battery with the inverter completely switched off (section AC and DC side) being careful to maintain the polarity
- W013 * - Clock broken -  *not visualised on display	Clock broken: The alarm occurs when there is a difference of over 1 minute in the time displayed compared to the internal time of the microprocessors and indicates a malfunction of the clock circuit.	<ul style="list-style-type: none"> • Error inside the inverter and cannot be checked externally. - If the alarm repeats persistently, contact customer assistance.
- W017* - String Err. -  * (only for models with monitored string fuses)	Error recorded in measuring string currents: Damaged string protection fuse(s)	<ul style="list-style-type: none"> • Check with a multimeter the state of the fuses (positioned on the fuse boards). - If one or more fuses is open, arrange to replace them and check that the input current on the string(s) does not exceed the rating of the fuses (should parallel strings have been made outside the inverter). - If there are no damaged string fuses and the inverter continues to show the alarm message check whether the settings to be made through the Aurora Manager software are correct (presence or absence of one or more input strings).
- W018 * - SPD DC Err -  * (only for models with monitored SPD)	Intervention of overvoltage surge arresters on DC side: Damaged overvoltage surge arresters positioned on DC side	<ul style="list-style-type: none"> • Observe the inspection window on each surge arrester (DC side). If it is red, the surge arrester is damaged and the cartridge must be replaced. - If the alarm status persists, even if all the surge arresters have a green inspection window, contact customer assistance.
- W019 * - SPD AC Err -  * (only for models with monitored SPD)	Intervention of overvoltage surge arresters on AC side: Damaged overvoltage surge arresters positioned on AC side	<ul style="list-style-type: none"> • Observe the inspection window on each surge arrester (AC side). If it is red, the surge arrester is damaged and the cartridge must be replaced. - If the alarm status persists, even if all the surge arresters have a green inspection window, contact customer assistance.
- W022 * - Reactive power mode changed -  *not visualised on display	Variation in means of managing reactive power: Variation in the means of managing reactive power; this change can be made through the display or advanced configuration software.	The variation in the means of managing reactive power is done directly by the customer/installer and is not an error. The information is only saved on the historic record of the events memorised by the inverter
- W023 * - date/time changed -  *not visualised on display	Variation in the inverter's date and time: Variation of the inverter's date and time; this change can be made through the display or advanced configuration software.	The variation in the inverter's date and time is done directly by the customer/installer and is not an error. The information is only saved on the historic record of the events memorised by the inverter
- W024 * - Energy data reset -  *not visualised on display	Zeroing of the statistical energy data memorised in the EEPROM: Reset of the energy data saved in the inverter; this operation can be handled through the display or advanced configuration software.	<ul style="list-style-type: none"> • The zeroing of the partial energy values memorised by the inverter is done directly by the customer/installer and is not an error. • The information is only saved on the historic record of the events memorised by the inverter • The notice may also occur on substitution of the Memory Card where the statistical production data is saved



- Code on display - Error message - Signal	Name of Alarm and Cause	Solution
- E001 - Input OC - ● Yellow LED	Input over-current (photovoltaic generator): The alarm occurs when the inverter's input current exceeds the inverter's threshold for maximum input current.	<ul style="list-style-type: none"> • Check whether the composition of the PV generator enables input current which exceeds the maximum threshold allowed by the inverter and that the configuration of the inputs (independent or in parallel) is carried out correctly. - If both checks are positive, contact customer assistance.
- E002 - Input OV - ● Yellow LED	Input over-voltage (photovoltaic generator): The alarm is generated when the input voltage (from the PV generator) exceeds the inverter's threshold of maximum input voltage. The alarm occurs before reaching the absolute threshold over which the inverter is damaged. When the inverter's input voltage exceeds the Over Voltage threshold, the inverter will not start up due to the generation of the alarm.	<ul style="list-style-type: none"> • It is necessary to measure the input voltage inside the inverter with a voltmeter. - If it is higher than the maximum voltage of the operating range, the alarm is genuine and it is necessary to check the configuration of the PV generator. If the voltage has also exceeded the maximum input threshold the inverter could be damaged. - If it is lower than the maximum voltage of the operating range, the alarm is caused by an internal malfunction and it is necessary to contact customer assistance.
- E003 - No Parameters - ● Yellow LED	DSP initialisation error: The main microcontroller cannot initialise correctly the two DSPs (booster stage and inverter stage). The error is caused by communication problems on the inverter's internal bus.	<ul style="list-style-type: none"> • Error inside the inverter and cannot be checked externally. - If the problem (once the inverter has been switched off and back on) persists, contact customer assistance.
- E004 - Bulk OV - ● Yellow LED	"Bulk" over-voltage (DC-DC circuit): Error inside the inverter. The alarm is raised when the voltage at the heads of the bulk capacitors exceeds the Over Voltage threshold (internal unchangeable threshold).	<ul style="list-style-type: none"> • The alarm may be triggered by causes external to the inverter: - An excessive input voltage can be recorded as a condition for bulk over voltage. In this case it is advisable to check the inverter's input voltage and should this value be close to the input OV threshold, review the configuration of the photovoltaic generator. - Excessive grid voltage could cause the bulk voltage to rise in uncontrolled fashion with a consequent protection intervention and hence generation of the alarm. In these cases the alarm is transitory and the inverter automatically restarts - The alarm may be triggered by causes inside the inverter and in this case it is necessary to contact customer assistance.
- E005 - Comm.Error - ● Yellow LED	Communication error inside the inverter: The alarm occurs when there are communication problems between the control devices inside the inverter.	<ul style="list-style-type: none"> • Error inside the inverter and cannot be checked externally. - If the problem (once the inverter has been switched off and back on) persists, contact customer assistance.
- E006 - Output OC - ● Yellow LED	Output over current: The alarm occurs when the inverter's output current exceeds the inverter's threshold for maximum output current.	<ul style="list-style-type: none"> • Error inside the inverter and cannot be checked externally. - If the problem (once the inverter has been switched off and back on) persists, contact customer assistance.
 - E007 - IGBT Sat - ● Yellow LED	Saturation recorded on the IGBT components: The alarm occurs when one of the inverter's active devices is in a saturated state.	Once the error occurs, the inverter tries to return to normal operation. <ul style="list-style-type: none"> - Should the error occur sporadically, it may be caused by a brusque transition of the grid voltage or of the input voltage, but is not due to a malfunction by the inverter. - If the error is connected to an internal breakdown, it will continue to appear and so it is necessary to contact customer assistance.
- E009 - Internal error - ● Yellow LED	Error inside the inverter: Error inside the inverter	<ul style="list-style-type: none"> • Error inside the inverter and cannot be checked externally. - If the problem (once the inverter has been switched off and back on) persists, contact customer assistance.
- E010 - Bulk Low - ● Yellow LED	Low "Bulk" voltage (DC-DC circuit): <ul style="list-style-type: none"> • The alarm may be triggered by causes external to the inverter: a reduced input voltage on the inverter (just above the activation voltage) but which is not accompanied by a sufficient availability of power from the photovoltaic generator (typical condition of the stages with limited irradiation) 	<ul style="list-style-type: none"> - If the error signal occurs sporadically, it may be due to causes external to the inverter (limited irradiation and so limited power availability from the PV generator). - If the problem occurs systematically also in conditions of high irradiation and with input voltage which is significantly higher than the activation voltage, contact customer assistance.
- E011 - Ramp Fail - ● Yellow LED	Long wait for "Booster" regime to start: Error internal to inverter relating to start up time for DC-DC circuit regime (Booster)	<ul style="list-style-type: none"> • Error inside the inverter and cannot be checked externally. - If the problem (once the inverter has been switched off and back on) persists, contact customer assistance.
- E012 - DcDc Fail - ● Yellow LED	Error in the "Booster" circuit (DC-DC side) recorded by the "Inverter" circuit (DC-AC side): Error internal to inverter relating to operation of the DC-DC circuit regime (Booster)	<ul style="list-style-type: none"> • Error inside the inverter and cannot be checked externally. - If the problem (once the inverter has been switched off and back on) persists, contact customer assistance.

- Code on display - Error message - Signal	Name of Alarm and Cause	Solution
<ul style="list-style-type: none"> - E013 - Wrong Mode - ● Yellow LED 	<p>Incorrect configuration of inputs (set in parallel rather than independent): The alarm is generated solely when the inverter is configured with parallel inputs. In this particular configuration the inverter checks the input voltage of each of the two channels and if the two voltages differ by more than 20Vdc, the alarm is raised .</p>	<ul style="list-style-type: none"> • Check that the setting of the "IN MODE" switch is specifically set to "PAR" and that the bridges between the two input channels have been included. - If the configuration of the inverter is correct, check that the input strings have the usual number of standard panels of the usual brand and with the same inclination/orientation. - If both the configuration of the inverter and the characteristics of the PV generator conform with the specifications, contact customer assistance.
<ul style="list-style-type: none"> - E014 - Over Temp. - ● Yellow LED 	<p>Excessive temperature inside the inverter: External temperature over 60°C. This parameter also depends on the power which the inverter must supply since the measurement of temperatures is done internally and is influenced by the heat dissipated by the components of the inverter itself</p>	<ul style="list-style-type: none"> • Check that the inverter is not exposed to direct sunlight. Wait for the temperatures to which the inverter is exposed to return to the operating range and for the inverter to cool down. - If the problem (once the ambient temperature has returned to the range) persists, contact customer assistance. Remember to wait the time needed to allow the inverter to cool down
<ul style="list-style-type: none"> - E015 - Bulk Cap Fail - ● Yellow LED 	<p>Breakdown recorded on the "Bulk" capacitor: Error inside the inverter relating to a problem in the bulk capacitors.</p>	<ul style="list-style-type: none"> • Error inside the inverter and cannot be checked externally. - If the problem (once the inverter has been switched off and back on) persists, contact customer assistance.
<ul style="list-style-type: none"> - E016 - Inverter Fail - ● Yellow LED 	<p>Error in the "Inverter" circuit (DC-AC side) recorded by the "Booster" circuit (DC-DC side): The alarm is generated when a problem is recorded in the inverter circuit (DC/AC)</p>	<ul style="list-style-type: none"> • Error inside the inverter and cannot be checked externally. - If the problem (once the inverter has been switched off and back on) persists, contact customer assistance.
<ul style="list-style-type: none"> - E017 - Start Timeout - ● Yellow LED 	<p>Long wait for "Inverter" regime to start up: Error internal to inverter relating to start-up time for the DC-AC circuit regime (Inverter) • The alarm may be triggered by causes external to the inverter: a reduced input voltage on the inverter (just above the activation voltage) but which is not accompanied by a sufficient availability of power from the photovoltaic generator (typical condition of the stages with limited irradiation)</p>	<ul style="list-style-type: none"> - If the error signal occurs sporadically, it may be due to causes external to the inverter (limited irradiation and so limited power availability from the PV generator). - If the problem occurs systematically also in conditions of high irradiation and with input voltage which is significantly higher than the activation voltage, contact customer assistance.
<ul style="list-style-type: none"> - E018 - Ground Fault - ● Red LED 	<p>High leakage current measured on the DC side (photovoltaic generator): The alarm is generated when, during normal operation of the inverter, a leakage current to ground is detected in the DC section of the system. It is also possible that the inverter generates the alarm E018 message also due to AC leakage currents connected to the capacitive nature of the photovoltaic generator compared to ground.</p>	<ul style="list-style-type: none"> • Measure the insulation resistance using a megohmmeter positioned between the photovoltaic field (positive terminal short-circuited at the negative pole) compared to ground. The measurement is strongly influenced by the environmental conditions, so must be made under the same conditions in which the error occurred. - If the value measured is lower than 1 megaohm, a check must be carried out by a technician/installer on the photovoltaic generator to identify and eliminate the problem. - If the value measured is higher than 1 megaohm and the error signal persists, contact customer assistance.
<ul style="list-style-type: none"> - E019 - Ileak sense.fail - ● Yellow LED 	<p>Failure of test on sensor to measure the leakage current (DC side): Before connecting to the grid the inverter runs a self-test regarding the sensor for the leakage current. The test is carried out by "forcing", in the sensor of the leakage current, a current with a known value: the microprocessor compares the value read with the known value. The error is generated if the comparison between the read value and the known value during the test does not fall within the allowed tolerance.</p>	<ul style="list-style-type: none"> • Error inside the inverter and cannot be checked externally. By its nature, the alarm only occurs prior to connection to the grid - If the problem (once the inverter has been switched off and back on) persists, contact customer assistance.
<ul style="list-style-type: none"> - E020 - Self Test Error 1 - ● Yellow LED 	<p>Failure of the test on the relay of the "Booster" (DC-DC circuit): Before connecting to the grid the inverter carries out internal tests. One of these tests concerns the correct operation of the booster relay. The test is carried out by "forcing" the switching of the relay and checking its operation. The error is generated if a problem is found in actioning the relay.</p>	<ul style="list-style-type: none"> • Error inside the inverter and cannot be checked externally. By its nature, the alarm only occurs prior to connection to the grid - If the problem (once the inverter has been switched off and back on) persists, contact customer assistance.



- Code on display - Error message - Signal	Name of Alarm and Cause	Solution
- E021 - Self Test Error 2 - ● Yellow LED	Failure of the test on the inverter's relay (DC-AC circuit): Before connecting to the grid the inverter carries out internal tests. One of these tests concerns the correct operation of the inverter relay. The test is carried out by "forcing" the switching of the relay and checking its operation. The error is generated if a problem is found in actioning the relay.	<ul style="list-style-type: none"> • Error inside the inverter and cannot be checked externally. By its nature, the alarm only occurs prior to connection to the grid - If the problem (once the inverter has been switched off and back on) persists, contact customer assistance.
- E022 - Self Test Error 4 - ● Yellow LED	Timeout of the tests undertaken on the relays inside the inverter: Execution time for the self-test carried out on the relay of the DC_AC (inverter) circuit too high. It may indicate a problem connected to the aforementioned relays	<ul style="list-style-type: none"> • Error inside the inverter and cannot be checked externally. - If the problem (once the inverter has been switched off and back on) persists, contact customer assistance.
- E023 - DC in error - ● Yellow LED	Feeding of continuous current to grid outside of range: The error is generated if the continuous component of the current supplied to the grid exceeds the threshold of 0.5% of the normal operating current. In any case the inverter is not blocked due to the E023 error, but tries to reconnect to the grid. The sporadic repetition of the error is a sign of serious grid distortions or sharp irradiation changes, while systematic repetition of the error signal will indicate a breakdown on the inverter	Once the error occurs, the inverter tries to return to normal operation. <ul style="list-style-type: none"> - Should the error occur sporadically, it may be caused by a brusque transition of the grid voltage or of the input voltage, but is not due to a malfunction by the inverter. - If the error is connected to an internal breakdown, it will continue to appear and so it is necessary to contact customer assistance.
- E024 - Internal error - ● Yellow LED	Error inside the inverter: Error inside the inverter	<ul style="list-style-type: none"> • Error inside the inverter and cannot be checked externally. - If the problem (once the inverter has been switched off and back nor) persists, contact customer assistance.
- E025* - Riso Low - ● Yellow LED *not visualised on display	Low value of insulation resistance: Before connecting to the grid the inverter measures the insulation resistance of the PV generator compared to ground. Should the measurement of the insulation resistance be below 1Mohm, the inverter does not connect to the grid and shows the "Riso Low" error. The causes may be: - PV panel(s) damaged; - Junction box(es) of the panels not correctly sealed, so as to permit infiltration by water and/or humidity; - Problems in connections between panels (not perfectly fit); - Poor quality of cable joints; - Presence in the DC section of unsuitable or damaged overvoltage surge arresters outside the inverter (reduced ignition voltage compared to the characteristics of the strings of the PV generator); - Presence of humidity inside any junction box	<ul style="list-style-type: none"> • Measure the insulation resistance using a megohmmeter positioned in the photovoltaic field (positive terminal short-circuited at the negative pole) compared to ground. The measurement is strongly influenced by the environmental conditions, so must be made under the same conditions in which the error occurred. - If the value measured is lower than 1 megaohm, a check must be carried out by a technician/installer on the photovoltaic generator to identify and eliminate the problem. - If the value measured is higher than 1 megaohm and the error signal persists, contact customer assistance.
- E026 - Vref Error - ● Yellow LED	Internal reference voltage outside of range: Wrong measurement of reference voltage inside inverter	<ul style="list-style-type: none"> • Error inside the inverter and cannot be checked externally. - If the problem (once the inverter has been switched off and back on) persists, contact customer assistance.
- E027 - Error Meas V - ● Yellow LED	Grid voltage outside of range: Error in the internal measurement of grid voltage (set by law) in order to have a redundant measurement (2 measurements on the same parameter made by two different circuits)	<ul style="list-style-type: none"> • Error inside the inverter and cannot be checked externally. - If the problem (once the inverter has been switched off and back on) persists, contact customer assistance.
- E028 - Error Meas F - ● Yellow LED	Grid frequency outside of range: Error in the internal measurement of grid frequency (set by law) in order to have a redundant measurement (2 measurements on the same parameter made by two different circuits)	<ul style="list-style-type: none"> • Error inside the inverter and cannot be checked externally. - If the problem (once the inverter has been switched off and back on) persists, contact customer assistance.
- E029 - Mid Bulk OV - ● Yellow LED	Internal over voltage on the measurement of the "Mid bulk": Error internal to the inverter (only triphase models)	<ul style="list-style-type: none"> • Error inside the inverter and cannot be checked externally. - If the problem (once the inverter has been switched off and back on) persists, contact customer assistance.



- Code on display - Error message - Signal	Name of Alarm and Cause	Solution
- E030 - Error Meas I leak - ● Yellow LED	High leakage current (DC side): Error in the internal measurement (made when the inverter is grid connected) of the leakage current of the DC side (PV generator) compared to ground (set by law) in order to have a redundant measurement (2 measurements on the same parameter made by two different circuits)	<ul style="list-style-type: none"> • Error inside the inverter and cannot be checked externally. - If the problem (once the inverter has been switched off and back on) persists, contact customer assistance.
- E031 - Error Read V - ● Yellow LED	Output relay damaged: Measurement of internal voltage on heads of the output relay outside of range. There is too great a difference in voltage between the input and output of the grid connection relay.	<ul style="list-style-type: none"> • Error inside the inverter and cannot be checked externally. - If the problem (once the inverter has been switched off and back on) persists, contact customer assistance.
- E032 - Error Read I - ● Yellow LED	Imbalanced output currents: Measurement of the unbalance in the output voltage (made across the three phases) outside of range (only in triphase models)	<ul style="list-style-type: none"> • Error inside the inverter and cannot be checked externally. - If the problem (once the inverter has been switched off and back on) persists, contact customer assistance.
- E033 - UTH - ● Yellow LED	Low ambient temperature: Temperature outside the inverter below -25°C	<ul style="list-style-type: none"> • Wait for the temperatures to which the inverter is exposed to return to the operating range. - If the problem persists, contact customer assistance. Remember to wait the time needed to allow the inverter to warm up
- E034 - Interlock fail - ● Yellow LED	“IGBT” circuitry not ready: Error inside the inverter	<ul style="list-style-type: none"> • Error inside the inverter and cannot be checked externally. - If the problem (once the inverter has been switched off and back on) persists, contact customer assistance.
- E035* - Remote Off - ● Yellow LED *not visualised on display	Inverter awaiting “remote ON” command: The inverter has been switched off remotely (remote OFF) and remains awaiting the signal which will switch it back on (Remote ON)	<ul style="list-style-type: none"> • Switch back on the inverter remotely. If the unit does not switch back on, disable the remote off/on function and switch the equipment off completely and subsequently switch it back on. - If the problem (once the Remote ON/OFF function from the display has been reactivated) persists, contact customer assistance.
- E036 - Vout Avg error - ● Yellow LED	Average of the measurements of grid voltage outside of range: The average value of the grid voltage (sampled every 10 minutes) does not fall within the permitted ranges. The grid voltage in the point connected to the inverter is too high. This may be caused by too high a grid impedance. In the final stage of the timeout, the inverter limits the power to check whether the grid voltage has stabilised into regular parameters. If this does not happen, the inverter disconnects from the grid	<ul style="list-style-type: none"> • Check the grid voltage in the connection point to the inverter. - If the grid voltage differs from the range due to the conditions of the distribution grid, ask the operator to adjust the grid voltage. If the operator authorises a change to the inverter's parameters, agree the new limits with customer assistance
- E037 - Riso Low - ● Red LED	Low value of the insulation resistance (only with the “Amorphous” mode activated): This error can occur only should the “Amorphous” mode be on. This function is on only in inverters equipped with a grounding kit and serves to monitor the voltage at the heads of the grounding resistance. The error occurs when the voltage at the heads of the resistance connected between ground and the pole of the photovoltaic generator exceeds 30V for more than 30 minutes or 120V for more than one second.	<ul style="list-style-type: none"> • Check for the presence and correct contact between the two terminals of the grounding resistance installed inside the inverter • Measure the insulation resistance using a megohmmeter positioned in the photovoltaic field (positive terminal short-circuited at the negative pole) compared to ground. The measurement is strongly influenced by the environmental conditions, so must be made under the same conditions in which the error occurred. - If the value measured is lower than 1 megaohm, a check must be carried out by a technician/installer on the photovoltaic generator to identify and eliminate the problem. - If the value measured is higher than 1 megaohm and the error signal persists, contact customer assistance.
E046 - String self test fail - ⊗ No LED	Error during the automatic check of the string voltages (only in models with the “fuse-control” board): In some inverter models it is possible to carry out the check test of the polarity of the strings connected to the input (e.g.:TRIO-20.0/27.6kW). This error signal occurs when, during the test stage, an inverted string is recorded	<ul style="list-style-type: none"> • Section the inverter and check the polarity of the string(s) which the inverter has recorded as inverted. - Once all the strings have been correctly connected, activate the system once again; the inverter will once again check the correct polarity of the string inputs at the end of which it will carry out the checks for the grid connection. - If the problem (once the inverter has been switched off and back on) persists, contact customer assistance.
E049 - AC FF Error - ● Yellow LED	Error in the “AC feed-forward” circuit: Error inside the inverter	<ul style="list-style-type: none"> • Error inside the inverter and cannot be checked externally. - If the problem (once the inverter has been switched off and back on) persists, contact customer assistance.



- Code on display - Error message - Signal	Name of Alarm and Cause	Solution
E056 - Over Temp. (from external box) - ● Yellow LED	Excessive temperature measured inside the inverter's wiring box: High internal temperature. This error relates to the temperature measured on external boxes (e.g.:TRIO-20.0/27.6kW).	<ul style="list-style-type: none"> • Check that the inverter is not exposed to direct sunlight. Wait for the temperatures to which the inverter is exposed to return to the operating range and for the inverter to cool down. - If the problem (once the ambient temperature has returned to the range) persists, contact customer assistance. Remember to wait the time needed to allow the inverter to cool down
E057 - Vbulk reading error - ● Yellow LED	Input voltage (Vin) higher than booster voltage (Vbulk): The error occurs if the input voltage exceeds the Bulk voltage (voltage on the DC-DC circuit inside the inverter)	<ul style="list-style-type: none"> • It is necessary to measure the input voltage inside the inverter with a voltmeter. - If it is higher than the maximum voltage of the operating range, the alarm is genuine and it is necessary to check the configuration of the PV generator. If the voltage has also exceeded the maximum input threshold the inverter could be damaged. - If it is lower than the maximum voltage of the operating range, the alarm is caused by an internal malfunction and it is necessary to contact customer assistance.
E058 - Pin vs Pout check error - ● Yellow LED	Error in the check of Pin vs Pout: The error occurs if the difference between the measured value of input power and that of output power is greater than the limit imposed internally to the inverter.	<ul style="list-style-type: none"> • Error inside the inverter and cannot be checked externally. - If the problem (once the inverter has been switched off and back on) persists, contact customer assistance.

Power limitation messages





The equipment can signal possible output power limitations which may occur on the basis of:

- settings made by the user
- settings required by the grid standard of the country of installation
- protective devices inside the inverter

The notices of messages are shown on the highlighted part **b10** of the display .

The following table gives the complete list of power limitation messages relating to string inverters. Some messages may not be used depending on the inverter model installed.

- Message on display - Signal	Name of Derating and Cause	Solution
- LIMxxx% CODE:00 - ▲ Display symbol b6	Power limitation: The message indicates that the user has set an output power limitation for the inverter. LIM xxx% = Power reduction percentage Examples: LIM 100% = no power limitation LIM 50% = limitation to 50% of the output nominal power	<ul style="list-style-type: none"> • Check the limitation value set in the "Settings > Power Limitation" menu
- LIMxxx% CODE:01 - ▲ Display symbol b6	Power limitation for over-frequency: The message indicates that the user has set a power limitation due to over frequency in order to reduce the maximum output power of the inverter when the grid frequency exceeds certain limits. LIM xxx% = Power reduction percentage Examples: LIM 100% = no power limitation LIM 50% = limitation to 50% of the output nominal power	<ul style="list-style-type: none"> • Check the limitation value set in the "Settings > Service > OF Derating" menu

- Message on display - Signal	Name of Derating and Cause	Solution
- LIMxxx% CODE:02 -  Display symbol <u>b6</u>	Power limitation for over-voltage: The message indicates that the user has set a power limitation due to over voltage (parameter U >(10 min)) in order to reduce the maximum output power of the inverter when the reading of the average grid voltage exceeds certain limits. The sampling of readings is done every 10 minutes (U>(10min)). LIM xxx% = Power reduction percentage Examples: LIM 100% = no power limitation LIM 50% = limitation to 50% of the output nominal power	<ul style="list-style-type: none"> • Check the limitation value set in the “Settings > Service > U > (10 min) Der.” menu
- LIMxxx% CODE:03 -  Display symbol <u>b6</u>	Anti-islanding power limitation: The message indicates that a power limitation is active since an "islanding" condition has been recorded. LIM xxx% = Power reduction percentage Examples: LIM 100% = no power limitation LIM 50% = limitation to 50% of the output nominal power	<ul style="list-style-type: none"> • If the inverter remains connected to the grid and the limitation is active, contact customer assistance
- LIMxxx% CODE:04 -  Display symbol <u>b6</u>	Power limitation due to low grid voltage: The message indicates that an output power limitation may occur since a low grid voltage (AC) condition has been recorded. LIM xxx% = Power reduction percentage Examples: LIM 100% = no power limitation LIM 50% = limitation to 50% of the output nominal power	<ul style="list-style-type: none"> • Check that the grid voltage is lower than the minimal voltage. Should this condition persist, contact the grid operator to resolve the problem.
- LIMxxx% CODE:05 -  Display symbol <u>b7</u>	Power limitation due to excess temperature: The message indicates that a power limitation is active since an excess temperature condition has been recorded inside the inverter (This parameter depends also on the power which the inverter must provide since the measurement of temperatures is taken internally and is influenced by the heat dissipated by the components of the inverter itself). LIM xxx% = Power reduction percentage Examples: LIM 100% = no power limitation LIM 50% = limitation to 50% of the output nominal power	<ul style="list-style-type: none"> • Check that the inverter is not exposed to direct sunlight. Wait for the temperatures to which the inverter is exposed to return to the operating range and for the inverter to cool down. - If the problem (once the ambient temperature has returned within the range) persists, contact customer assistance.
- LIMxxx% CODE:06 -  Display symbol <u>b6</u>	Power limitation for input over-voltage: The message indicates that a power limitation is active since an input over voltage (AC) has been recorded. LIM xxx% = Power reduction percentage Examples: LIM 100% = no power limitation LIM 50% = limitation to 50% of the output nominal power	<ul style="list-style-type: none"> • It is necessary to measure the input voltage inside the inverter with a voltmeter. - If it is higher than the maximum voltage of the operating range, the alarm is genuine and it is necessary to check the configuration of the PV generator. If the voltage has also exceeded the maximum input threshold the inverter could be damaged. - If it is lower than the maximum voltage of the operating range, the alarm is caused by an internal malfunction and it is necessary to contact customer assistance.



Putting the inverter out of service

Before proceeding to putting the inverter out of service, it is necessary to disconnect it in order to remove the connections safely and without any dangerous voltages.

Below is the procedure for putting the inverter out of service:

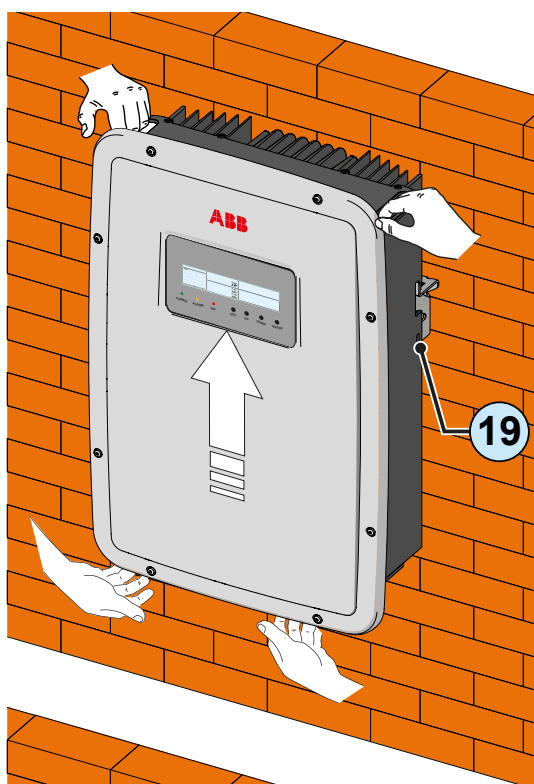

- Once the inverter has been disconnected, wait for it to discharge and proceed to opening the front cover by unscrewing the 8 fixing screws

- Remove all the connections on the inverter.

- Unscrew and remove the 2 blocking screws ⑲ located on the sides of the inverter

- Lift and remove the inverter by uncoupling it from the bracket

- Reclose the cover and tighten the 8 fixing screws

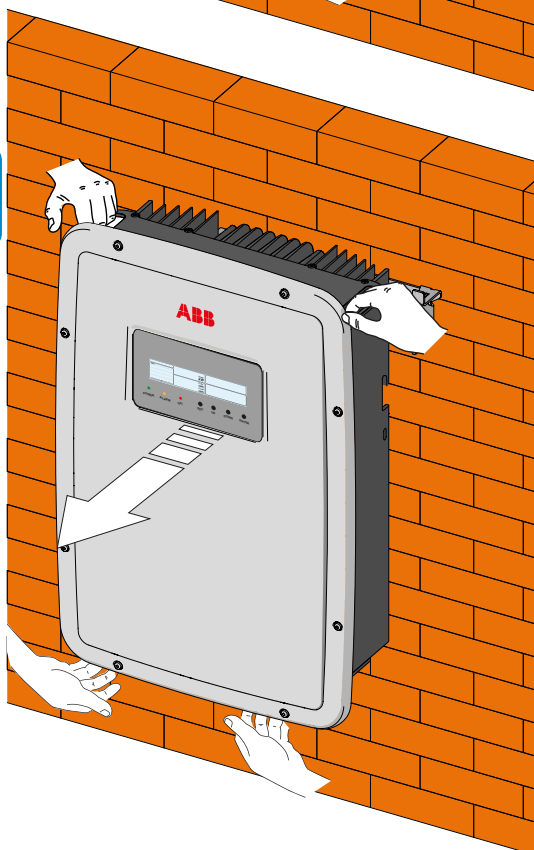

Registration on “Registration” website and calculation of second-level password (Service Menu)

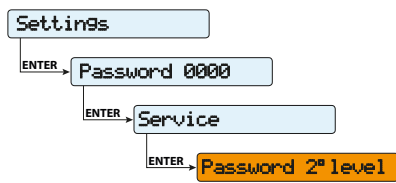

In order to obtain the second-level password needed to access the inverter's service menu, it is necessary to go through the following stages:

Stage 1 - Collection of information relating to the inverter.

Collect the following information relating to each inverter for which you wish to have a password:

- **S/N** - Serial number of the inverter. This information can be found on the label giving the identity details of the inverter or on the display by accessing the “INFORMATION” menu→Serial No.”

The serial number consists of 6 digits (the last 6 in models with a label giving a 10-digit S/N)

- **WK** - Production week. This information can be found on the label giving the identity details of the inverter or on the display by accessing the “INFORMATION” menu→Serial No.”

The production week consists of 4 figures, indicating the week (first 2 digits) and the year of production (last 2 digits)

- **Update Version** - This information is available only for some inverter models and can be found on the display by accessing the menu “INFORMATION→Firmware”.

Stage 2 - Registration on <https://registration.abbsolarinverters.com>

- Go online and access <https://registration.abbsolarinverters.com>

- Set the desired language and click on the specific icon to start registration

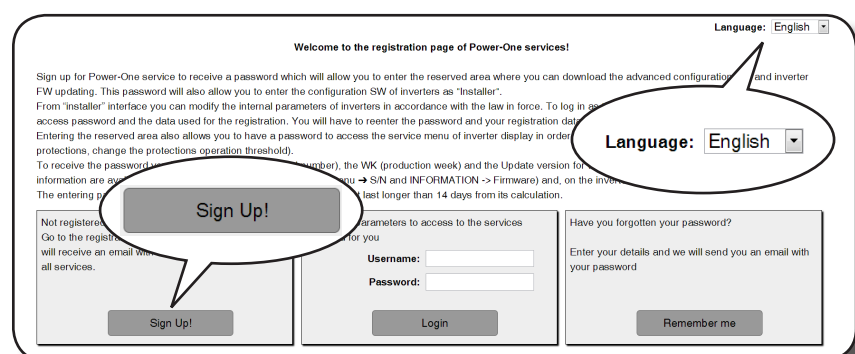

- Insert the personal data requested and end the registration stage

- An email will be sent to the email address used with a link to complete the registration process.

- Once the registration process is over, a further email will be sent with the password to access the website.

The password obtained enables access also to the advanced “Installer” mode present on the configuration software for inverters. The configuration software can be downloaded in a specific section of the website <https://registration.abbsolarinverters.com>



Stage 3 - Request for second level password

- Go online and access <https://registration.abbsolarinverters.com>
- Insert the Username (corresponding to the email used during registration) and the Password obtained at the end of Stage 2

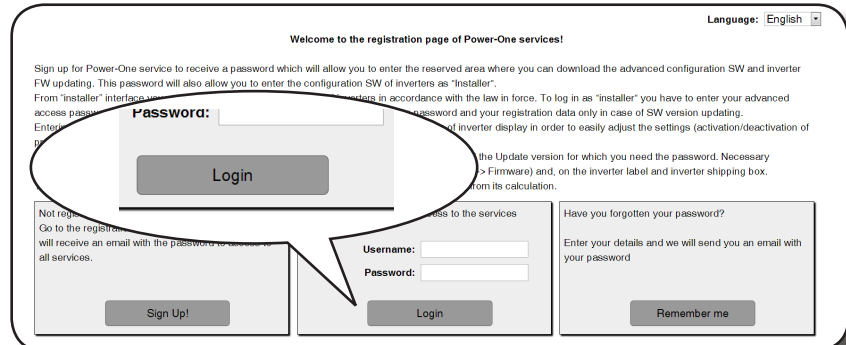

- Access the section dedicated to requesting the second-level password

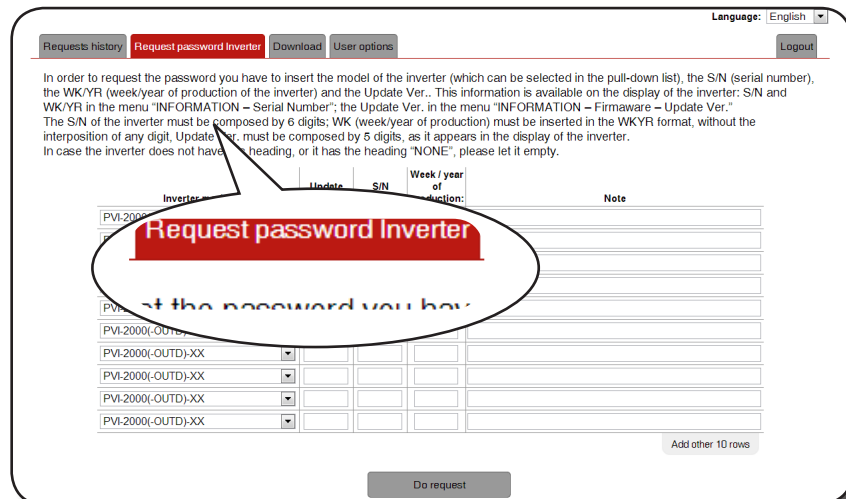

- Choose the inverter model from the drop-down list and insert Update Ver., Serial Number and Week of Production of the inverter which were obtained previously (Stage 1)

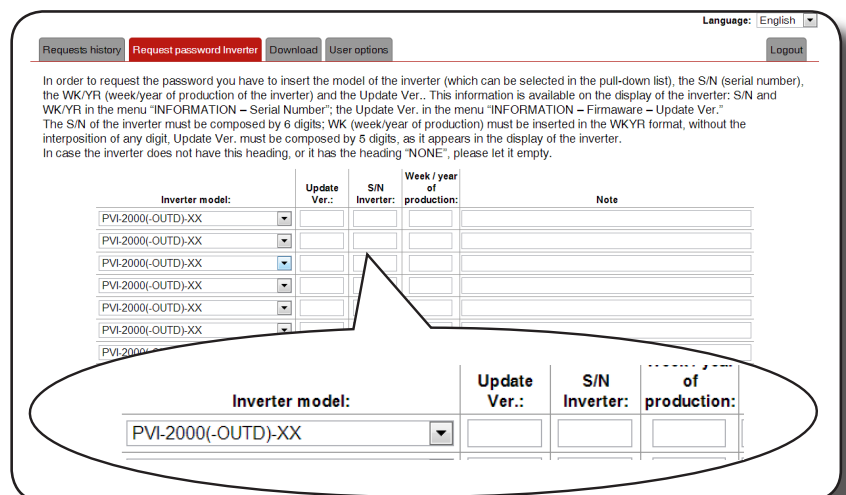

- Click on icon to request password.

Language: English

Requests history | Request password Inverter | Download | User options | Logout

In order to request the password you have to insert the model of the inverter (which can be selected in the pull-down list), the S/N (serial number), the WK/YR (week/year of production of the inverter) and the Update Ver.. This information is available on the display of the inverter: S/N and WK/YR in the menu "INFORMATION – Serial Number"; the Update Ver. in the menu "INFORMATION – Firmware – Update Ver."
The S/N of the inverter must be composed by 6 digits; WK (week/year of production) must be inserted in the WKYR format, without the interposition of any digit, Update Ver. must be composed by 5 digits, as it appears in the display of the inverter.
In case the inverter does not have this heading, or it has the heading "NONE", please let it empty.

Inverter model:	Update Ver.:	S/N Inverter:	Week / year of production:	Note
UNO-2.0-I-OUTD	12345	123456	0513	
PVI-3.0-OUTD-XX		987654	0412	
TRIO-27.6-TL-OUTD	13052	564789	4812	
PVI-2000(-OUTD)-XX				
PVI-2000(-OUTD)-XX				
PVI-2000(-OUTD)-XX				
PVI-2000(-OUTD)-XX				
PVI-2000(-OUTD)-XX				
PVI-2000(-OUTD)-XX				
PVI-2000(-OUTD)-XX				

Do request

Add other 10 rows

Do request



Should there be an error in inputting data, the fields containing the error will be highlighted in red. If, on the other hand, the data are correct, the passwords will be shown in a new window and at the same time sent to the email address used for registration.



The second-level password enables access to the service menu which allows the inverter's sensitive parameters to be changed. Proceed to changing the aforementioned parameters only when requested by the grid operator or by customer assistance.



Resetting the time remaining to change the grid standard

From the time a valid grid standard is entered and the inverter is turned on, a period of 24 hours is available to modify the grid standard setting.



The 24 hours are counted only when the inverter is turned on.

Check that the date and time are set correctly. Otherwise it may not be possible to access the "Service" menu to reset the timer.

After this period of time the system will block changes to the standard; and it will be necessary to carry out the following procedure to reset the remaining time and obtain another 24 hours to select a new grid standard:

Settings

1. Access the "SETTINGS" menu by entering the first-level password (default 0000)

Service

2. Access the "Service" sub-menu by entering the second-level password



The password to access the "Service" menu can be obtained by registering at the site <https://registration.abbsolarinverters.com>

Before accessing the site it will be necessary to locate the information utilized to compute the password:

Inverter model

Serial number and week of manufacture

Update field

The "Update" field is available only if the firmware of the inverter has been previously updated. If not available leave the field blank when requesting the password

The password obtained is valid for a period of 15 days

Reset Country S.

3. Select "Reset Country S." to reset the 24 hours of operation in which the grid standard may be modified..

Replacement of the buffer battery

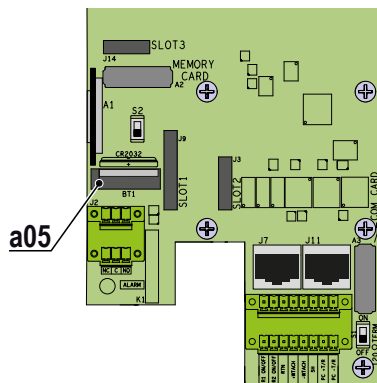

Replacement of the buffer battery may be necessary in case of:

1. Error signal on display
2. Reset of the date and time settings

The battery is of the **CR2032 type** and is installed on the communication board.

Procedure to replace the buffer battery:

1. Disconnect the inverter by removing the AC and DC disconnect switches
2. Open the front cover
3. Remove the battery to be replaced
4. Install the new battery, taking care to handle it with insulating gloves in order not to compromise the charge and respecting the polarity shown on the diagram on the communication board

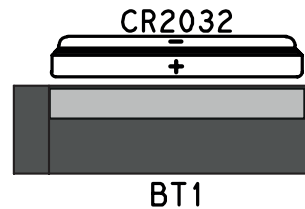
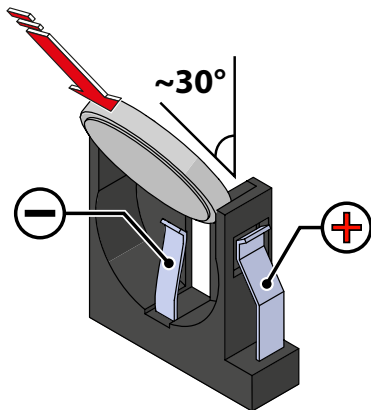

5. Close the front cover
6. Carry out the procedure for the commissioning of the inverter



Verification of ground leakage

In the presence of anomalies or report of ground fault (where provided), there may be a ground leakage from the PV generator (DC side).

To check this, measure the voltage between the positive pole and ground and between the negative pole (of the PV generator) and ground using a voltmeter whose input accepts a voltage sufficient for the dimensions of the photovoltaic generator.

Behaviour of a system without leakage

Due to the capacitive effect of the PV generator, during the first moments that the voltmeter is connected between one of the two poles and ground, it will measure a voltage of about $V_{oc}/2$, which will tend to stabilize to around 0V if there is no ground leakage, as shown in the graph below:

The internal resistance of the voltmeter tends to zero the voltage present on the PV generator due to the capacitive effect.

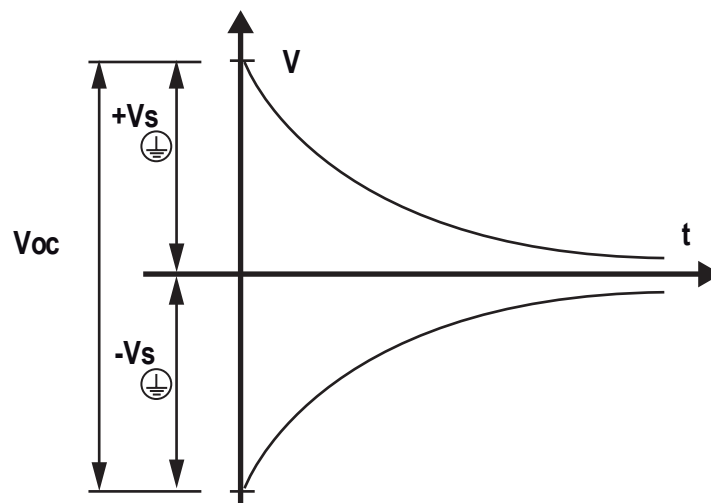

How to make the measurement:

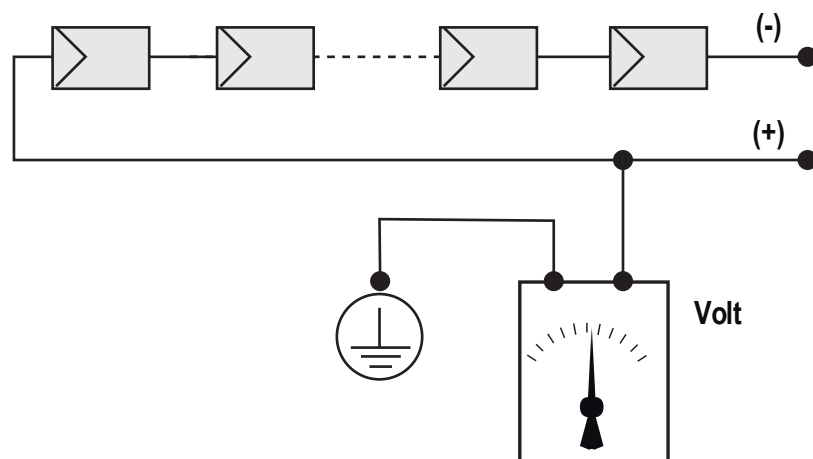

Behaviour of a system with leakage

If the voltage measured between one of the two poles and ground does not tend to 0V and stabilizes on a value, there is a ground leakage from the PV generator.

Example: When the measurement is made between positive pole and ground, a voltage of 200V is measured.

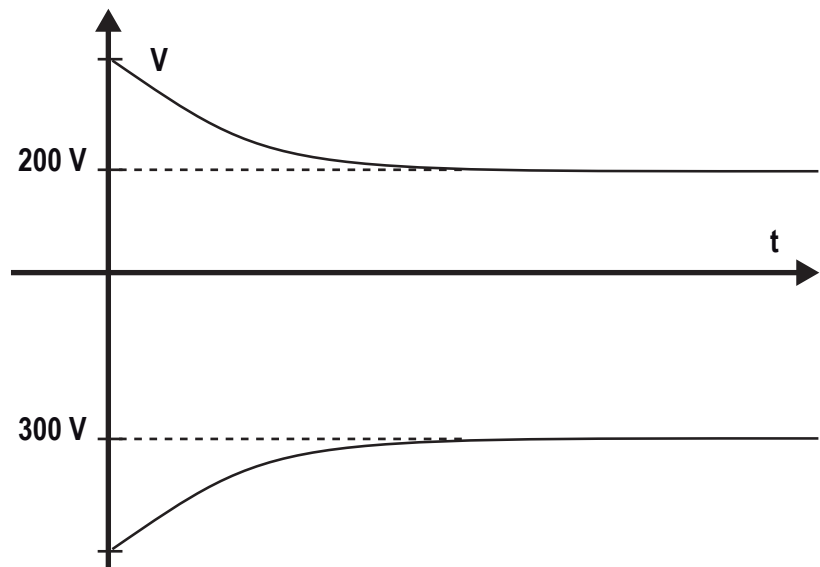

This means that if the system is made up of 10 modules in series and each one supplies 50V, the leakage can be located between the 4th and 5th PV module.

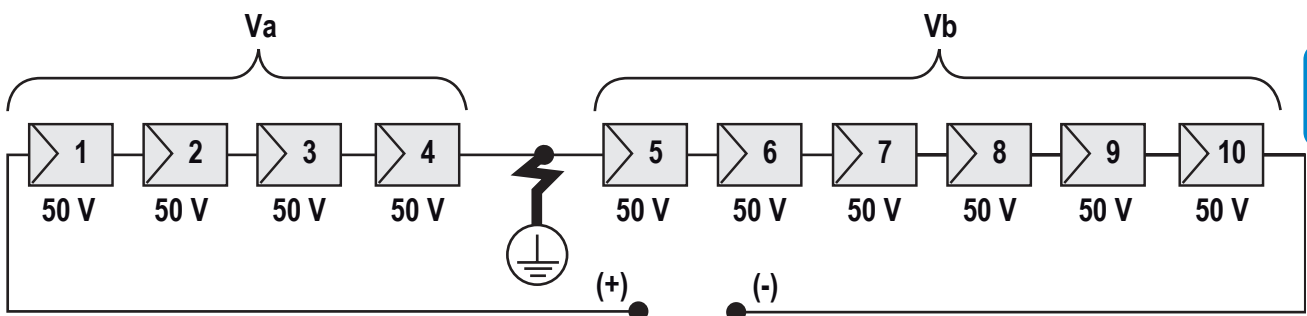

V_a = voltage measured between + pole and \oplus = 200V

V_b = voltage measured between - pole and \oplus = 300V

In all measurements with \oplus , the ground of the inverter is indicated.

Measuring the insulation resistance of photovoltaic generator

To measure the insulation resistance of the PV generator compared to ground (⊕), the two poles of the PV generator must be short-circuited (using a suitably sized switch).

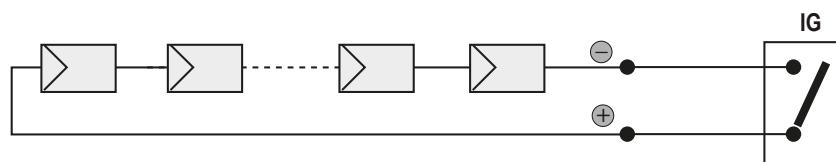

Once the short-circuit has been made, measure the insulation resistance (Riso) using a megohmmeter positioned between the two shorted poles and ground (of the inverter).

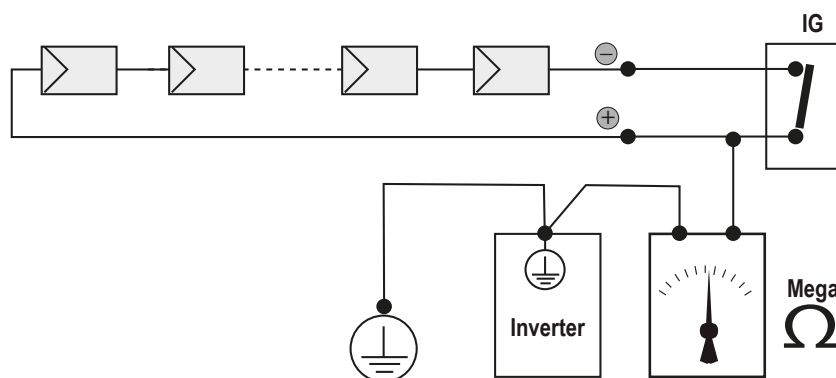

-TL MODELS (transformerless). If the measured insulation resistance (Riso) is less than 1Mohm the inverter does not connect to the grid due to a low insulation of photovoltaic generator respect to ground.

-I MODELS (with high frequency transformer). If the measured insulation resistance (Riso in case of input poles floating respect to ground or QF=1 if the one of input poles is grounded) is less than 0.2Mohm the inverter does not connect to the grid due to a low insulation of photovoltaic generator respect to ground.

The insulation resistance is affected by the environmental conditions the PV generator is in (E.g.: photovoltaic module wet from dump or rain), and therefore the measurement must be made immediately after the anomaly

Storage and dismantling

Storage of the equipment or prolonged stop

If the equipment is not used immediately or is stored for long periods, check that it is correctly packed and contact ABB for storage instructions. The equipment must be stored in well-ventilated indoor areas that do not have characteristics that might damage the components of the equipment.

Restarting after a long or prolonged stop requires a check and, in some cases, the removal of oxidation and dust that will also have settled inside the equipment if not suitably protected.

Dismantling, decommissioning and disposal

ABB CANNOT be held responsible for disposal of the equipment: displays, cables, batteries, accumulators, etc., and therefore the customer must dispose of these substances, which are potentially harmful to the environment, in accordance with the regulations in force in the country of installation.

If the equipment is dismantled, in order to dispose of the products that it is composed of, you must adhere to the regulations in force in the country of destination and in any case avoid causing any kind of pollution.

Dispose of the various types of materials that the parts of the equipment consist of in dumps that are suitable for the purpose.



Table: disposal of components

COMPONENT	MATERIAL OF CONSTRUCTION
Frame, brackets, supports	Arc-welded steel FE37
Casing or covers	ABS, plastic
Paint and	RAL
Gaskets and seals	Rubber / Teflon / Viton
Electrical cables	Copper / Rubber
Conduits	Polyethylene / Nylon
Back-up battery	Nickel / Lead/ Lithium

Further information

For more information on ABB products and services for solar applications, navigate to www.abb.com/solarinverters

Contact us

www.abb.com/solarinverters