

MECHANICAL DIAGRAMS

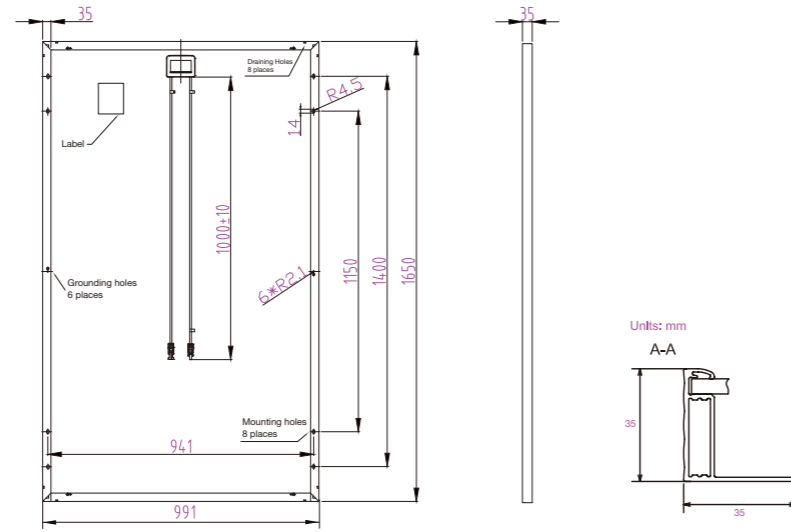
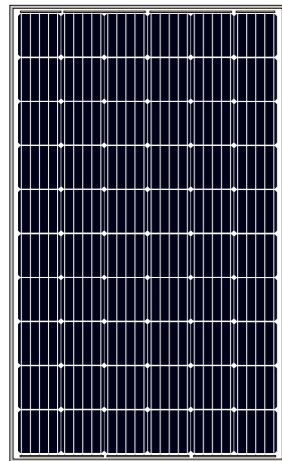

SPECIFICATIONS	
Cell	Quasi-Full Square Mono 156.75×156.75mm
Weight	18.2kg±3%
Dimensions	1650×991×35mm
Cable Cross Section Size	4mm <sup>2</sup>
No. of cells	60 (6×10)
Junction Box	IP67, 3 diodes
Connector	MC4 Compatible
Packaging Configuration	30 Per Pallet

OPERATING CONDITIONS	
Maximum System Voltage	1000V DC (IEC)
Operating Temperature	-40°C~+85°C
Maximum Series Fuse	20A
Maximum Static Load, Front	5400Pa
Maximum Static Load, Back	2400Pa
NOCT	45±2°C
Application Class	Class A

ELECTRICAL PARAMETERS AT STC					
TYPE	JAM60S01 -285/PR	JAM60S01 -290/PR	JAM60S01 -295/PR	JAM60S01 -300/PR	JAM60S01 -305/PR
Rated Maximum Power (Pmax) [W]	285	290	295	300	305
Open Circuit Voltage (Voc) [V]	39.25	39.46	39.64	39.85	40.05
Maximum Power Voltage (Vmp) [V]	31.70	31.80	32.03	32.26	32.57
Short Circuit Current (Isc) [A]	9.46	9.57	9.66	9.75	9.85
Maximum Power Current (Imp) [A]	8.99	9.12	9.21	9.30	9.37
Module Efficiency [%]	17.43	17.74	18.04	18.35	18.65
Power Tolerance	-0~+5W				
Temperature Coefficient of Isc (α <sub>Isc</sub> )	+0.060%/°C				
Temperature Coefficient of Voc (β <sub>Voc</sub> )	-0.300%/°C				
Temperature Coefficient of Pmax (γ <sub>Pmp</sub> )	-0.390%/°C				
STC	Irradiance 1000W/m <sup>2</sup> , cell temperature 25 °C, AM 1.5G				

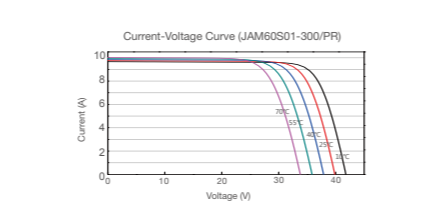
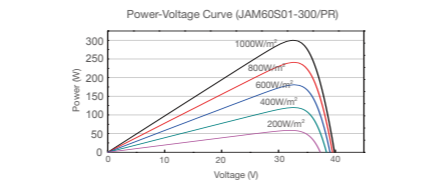
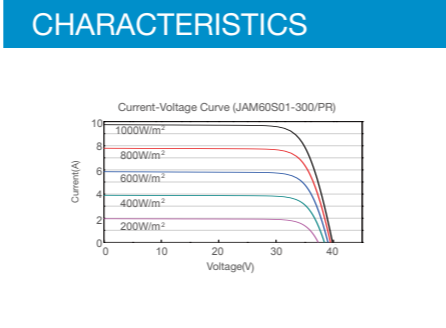

ELECTRICAL PARAMETERS AT NOCT					
TYPE	JAM60S01 -285/PR	JAM60S01 -290/PR	JAM60S01 -295/PR	JAM60S01 -300/PR	JAM60S01 -305/PR
Max Power (Pmax) [W]	209	213	217	221	224
Open Circuit Voltage (Voc) [V]	36.11	36.34	36.57	36.75	36.95
Max Power Voltage (Vmp) [V]	29.37	29.56	29.63	29.69	29.90
Short Circuit Current (Isc) [A]	7.53	7.61	7.69	7.78	7.86
Max Power Current (Imp) [A]	7.13	7.21	7.32	7.43	7.50
NOCT	Irradiance 800W/m <sup>2</sup> , ambient temperature 20°C, wind speed 1m/s, AM 1.5G				

305W Mono Si 60Cells  
20W More than Industrial Average

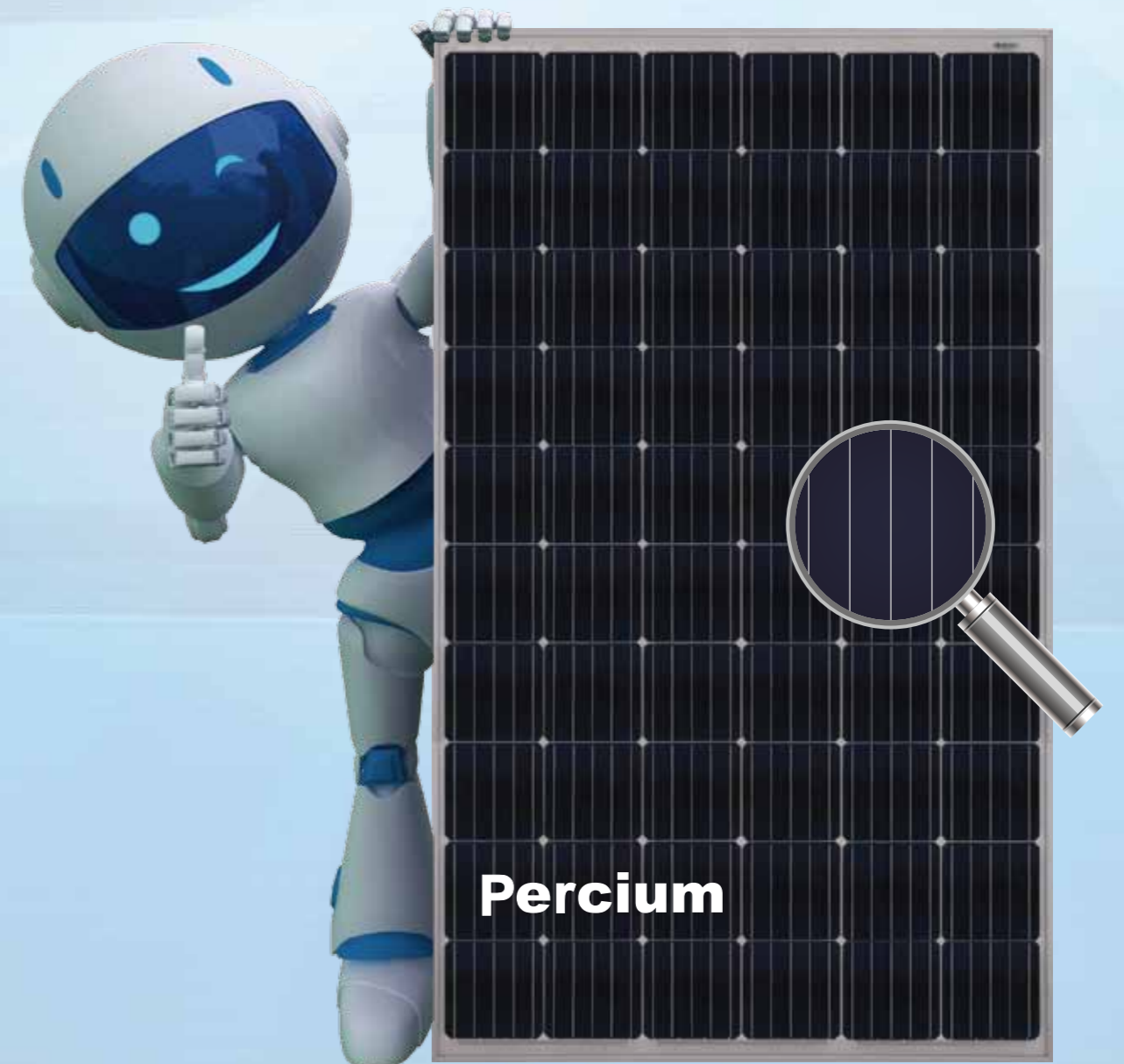

Harvest the Sunshine  
Premium Cells, Premium Modules

### Percium Cell

- The mono Si cell technology with passivated backside and local BSF
- >21% average mass production efficiency

### Average Mass Production Efficiency >21%

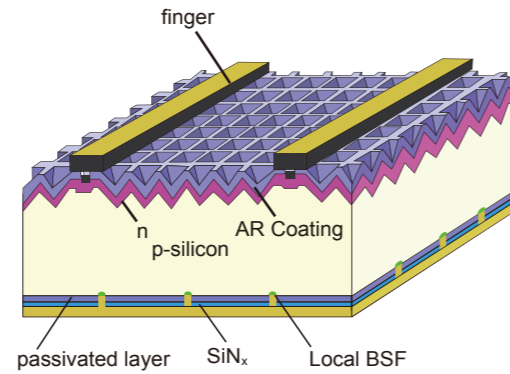

### Benefit: 7% More Power

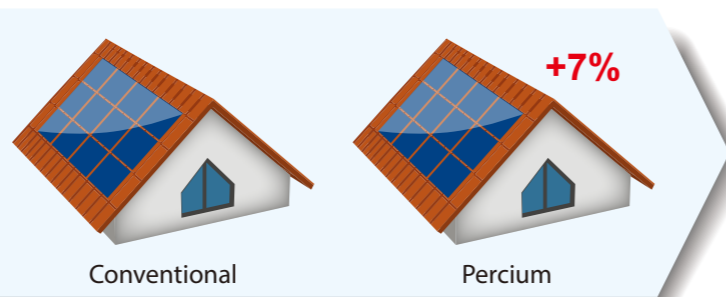

Percium module 300Wp VS Conventional module 280Wp

### More Power Per m<sup>2</sup>

Higher conversion efficiency - more power production per unit area

### Lower System Cost

Higher conversion efficiency help you save

- Transportation cost
- Installation cost
- BOS cost

### Benefit: Save System Costs Per Watt



Cost saving estimation made by comparison between 280W and 300W modules

### Excellent Low-light Performance

Enhanced spectral response at longer wavelength boosts low-light performance, which can produce more than 3% additional power compared with conventional module at system side.

### Benefit: Excellent Low-light Performance

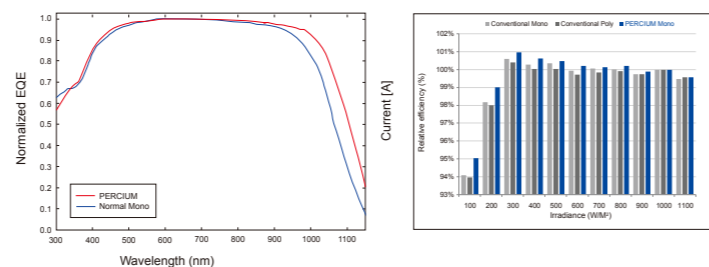

EQE—External quantum efficiency      Relative module efficiency comparison under different irradiance

Source:

### High Reliability

- Long-term reliability tests
- Harsh climate environment endurance tests
- PID-resistance tests in accordance to IEC62804
- Certified by TÜV SÜD and ETL
- Industry-leading cell technology
- High quality components from best suppliers
- Manufacturing inspected and certified by PI-Berlin and Solar-IF
- 100% in-house automatic manufacturing



### Other Features

- Positive power tolerance: 0~+5W
- Modules binned by current to improve system performance
- Excellent mechanical load resistance: Certified to withstand high wind loads (2400Pa) and heavy snow loads (5400Pa)

### Comprehensive Certificates

- IEC 61215, IEC 61730, UL1703, CEC Listed, MCS and CE
- ISO 9001: 2008: Quality management systems
- ISO 14001: 2004: Environmental management systems
- BS OHSAS 18001: 2007: Occupational health and safety management systems
- Environmental policy: The first solar company in China to complete Intertek's carbon footprint evaluation program and receive green leaf mark verification for our products



Specifications subject to technical changes and tests. JA Solar reserves the right of final interpretation.

### JA Solar Holdings Co., Ltd.

JA Solar Holdings Co., Ltd is a world leading manufacturer of high-performance solar power products that convert sunlight into electricity for residential, commercial and utility-scale power generation. The company was founded in May 2005 and publicly listed on NASDAQ in February 2007. JA Solar has been the world's leading cell producer since 2010, and has firmly established itself as a tier 1 module supplier since 2012. Capitalizing on our strength in solar cell technology, we are committed to provide modules with unparalleled conversion efficiency, yield efficiency, and reliability to enable you to maximize your returns on PV projects. With its leading industry experience, continuous effort on R&D, customer-oriented service and solid financial status, JA Solar is your best choice of long-term trustworthy partner.

Address: Building No.8, Nuode Center, Automobile Museum East Road, Fengtai District, Beijing, China  
 Telephone: +86 (10) 63611888  
 Fax: +86 (10) 63611999  
 Email: sales@jasolar.com market@jasolar.com

### Product Warranty

- 12-year product warranty
- 25-year linear power warranty

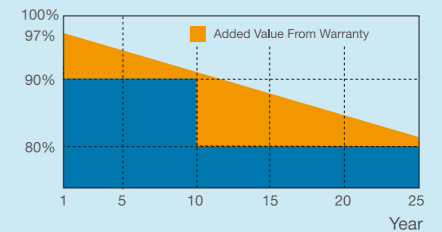

### Additional Insurance Options



### Partner Section