Installation and operation manual

Q.PEAK DUO ML-G11.X solar module series



1 Introduction	3
2 Planning	5
2.1 Technical specifications	5
2.2 Requirements	6
2.3 Mounting options	7
2.4 Electrical layout	10
3 Installation	11
3.1 Safety and transport	11
3.2 Preparation of installation	13
3.3 Module installation	14
4 Electrical connection	15
4.1 Safety	15
4.2 Electrical installation safety	16
4.3 Connection of modules	17
4.4 After installation	18
5 Grounding	19
6 Faults and defects	19
7 Disposal	19
8 Maintenance and cleaning	20

1 Introduction

With solar modules from Hanwha Q CELLS GmbH (hereafter referred to as "Qcells") you can directly transform the sun's limitless energy into environmentally-friendly solar electricity. In order to ensure the maximum performance of your Qcells solar modules, please read the following instructions carefully and observe all guidelines. Non-compliance may result in damage and/or physical injury.

This installation and operation manual (hereafter also referred to as the "Manual") provides instructions for the safe installation and operation of crystalline solar modules.

- Please read these instructions carefully before proceeding with your installation.
- Please retain these instructions for the life of the solar modules.
- Please ensure that this Manual is available to the operator at all times.
- This Manual should be given to all subsequent owners or users of the solar modules.
- All supplements received from the manufacturer should be included.
- Please observe all other applicable documents.
- If your questions are not satisfactorily answered in the manual, please contact your system supplier.

Additional information can be found on our website at www.qcells.com.

Intended use

This manual is valid for Africa, Asia, Europe, Latin America and South America. These instructions contain information regarding the safe handling and use of quality crystalline solar modules from Qcells and their installation, mounting, wiring, maintenance and disposal.

Symbols and Labels

The following symbols and labels are used throughout the Manual for ease of use.

SYMBOL	DESCRIPTION
→	Procedure with one or more steps.
■	Lists of items.
✓	Ensure that when carrying out a procedure, you check the results of said procedure.
⊘	Prohibited.

Beware of possible danger or damage.
Categories:

- Danger: Risk of fatal injury
- Attention: Risk of serious injury or damage to property
- Note: Risk of damage to product

Safety Regulations

In particular the installer as well as the operator of a module is responsible for compliance with all applicable statutory requirements and regulations.

→ Unless otherwise specified by any laws or regulations, the following stipulations must be upheld at all times during the installation, operation, and maintenance of the solar modules:

- This manual.
- Other applicable stipulations (such as country-specific regulations for pressure equipment, operational safety, hazardous goods, and environmental protection).
- Regulations and requirements specific to the system.
- Any applicable laws and requirements, in particular international, country specific, regional laws and stipulations governing the planning, installation, and operation of solar power systems and work on roofs.
- Any valid international, national and regional regulations governing work with direct current, especially those applicable to the installation of electrical devices and systems, and regulations issued by the respective energy provider governing the parallel operation of solar power systems.
- Any international, country specific and regional accident-prevention regulations.
- Other applicable stipulations provided by the relevant national institutions regarding safety in the installation and operation of electrical items.

Qualified and Skilled Personnel

Both, the installer and operator are responsible for ensuring that the installation (including connection to the grid), maintenance and dismantling are carried out by trained and qualified specialists with approved training certificates (issued by a state or federal organization) for the respective specialist trade. Electrical work may only be performed by an officially certified tradesperson in accordance with the stipulations applicable in the relevant country with regard to standard and regulations (in Germany e.g. DIN standards, VDE regulations) and the stipulations of the local grid operator and/or energy provider.

1 Introduction

Validity

These instructions are only valid for crystalline solar modules from the company Qcells as specified at chapter "2.1 Technical specifications". Qcells assumes no liability for damage resulting from failure to observe these instructions.

- Please observe the wiring and dimensioning of the system.
- The installer of the system is responsible for compliance with all necessary safety regulations during set-up and installation. Qcells assumes no liability on the basis of these instructions. Qcells is only liable in the context of contractual agreements or in the context of accepted guarantees. Qcells accepts no other responsibility for the functionality and safety of the modules.
- Please observe the instructions for any other system components that may be part of the complete solar power system. It may be necessary to carry out a structural analysis for the entire project.

Additional information for the Operator

- Please keep this manual for the entire life of the solar power system.
- Please contact your system supplier for information concerning the formal requirements for solar power systems.
- Please be sure to contact the relevant local authorities and energy providers regarding regulations and permit requirements prior to installation of the solar power system. Your financial success depends on the fulfillment of these requirements.

Other applicable documents

In addition to this Manual following technical information are relevant:

Document type
Product data sheet
Packaging and transport information

MISUSE OR INCORRECT USE OF SOLAR MODULES VOIDS THE LIMITED WARRANTY AND MAY CREATE A SAFETY HAZARD AND RISK PROPERTY DAMAGE. THIS INCLUDES IMPROPER INSTALLATION OR CONFIGURATION, IMPROPER MAINTENANCE, UNINTENDED USE, AND UNAUTHORIZED MODIFICATION.



This marking indicates that this product should not be disposed of with other household waste within the EU. Recycle this product properly to prevent possible damage to the environment or a risk to human health via uncontrolled waste disposal and in order to promote the sustainable reuse of material resources. Please return your used product to an appropriate collection point or contact the retailer where you purchased this product. Your retailer will accept used products and return them to an environmentally-sound recycling facility.



2 Planning

2.1 Technical specifications

For additional information see the relevant datasheet of the module provided at www.qcells.com.

PRODUCT LINE	Q.PEAK DUO ML-G11.2
Type	Q.ANTUM DUO Z
Length	2054 mm
Width	1134 mm
Frame height	32 mm
Area	2.33 m ²
Weight	26.0 kg
Max. system voltage V _{sys}	1500 V
Max. reverse current	25 A
Permissible temperature range	-40 °C to +85 °C (-40 °F to +185 °F)
Junction box protection class	IP67 with bypass diode
Connector protection class	IP68
Fire rating based on ANSI/UL 61730	C/Type 1
Max. test load Push/Pull ¹	5,400 Pa / 2,400 Pa
Max. design load Push/Pull ¹	3,600 Pa / 1,600 Pa
Certificates	CE-compliant; IEC 61215:2016; IEC 61730:2016; PV module classification: Class II

¹ Test and design load in accordance with IEC 61215:2016, depending on mounting options (see section "2.3 Mounting options")

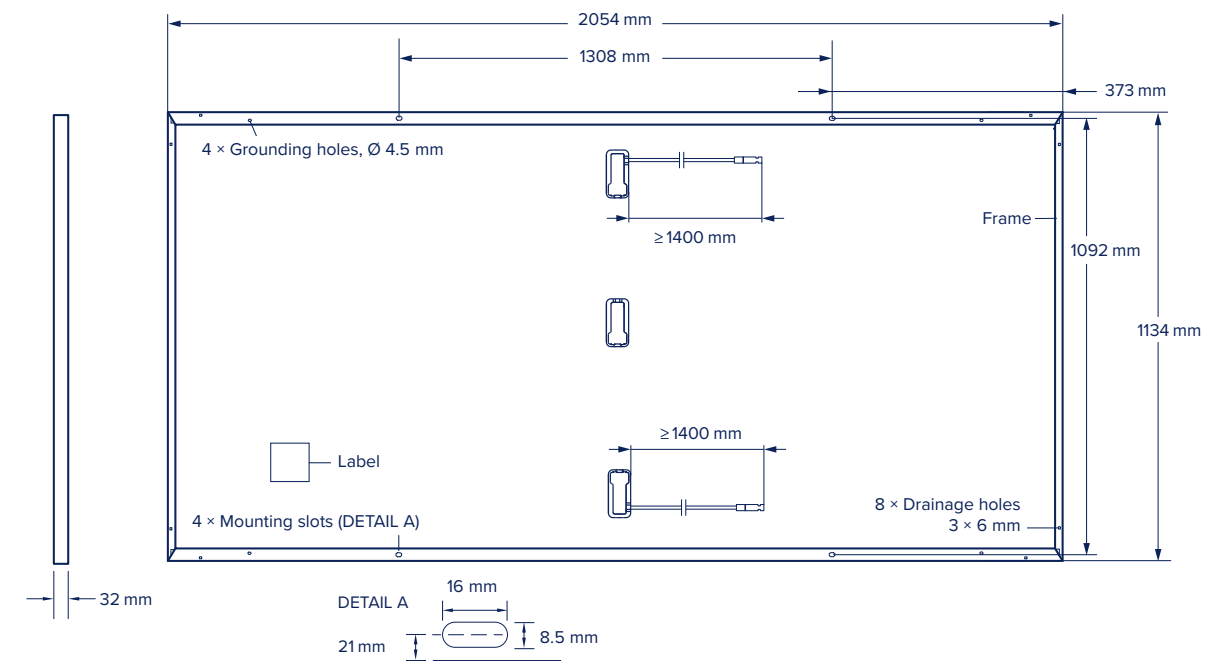

Fig. 1: External dimensions and components for Q.PEAK DUO ML-G11.2.

2 Planning

2.2 Requirements

Installation Site

Please note the following guidelines that apply to the installation site:

- Solar modules are not explosion-proof and are not suitable for use in explosive environments.
- Do not operate solar modules near highly flammable gas and vapors (e.g. gas tanks, gas stations).
- Do not install modules in enclosed space.
- Do not install modules in locations where they may be submerged in water (e.g. floodplains).
- Do not use modules as a substitute for the normal roofing (e.g. modules are not watertight).
- Do not install modules in close proximity to air conditioning systems.
- Do not install modules above 4000m (13120ft) altitude above sea level.
- Contact with saline water (e.g. spray water from the sea) and salt aggregation on the modules must be avoided.
- Do not bring any chemical substance (e.g. oil, solvent etc.) into contact with any part of the panel. Only substances, which are released by Qcells, are allowed to be used during installation, operation and maintenance.
- Any installation of modules on surfaces of water is prohibited. This includes installations on floating as well as pile-based platforms. Qcells may extend the coverage of its warranty to such installations, based on a case by case assessment of the system design and location. A prior written consent by the warrantor is required in any case.

The solar modules are designed for the following applications:

- Operating temperatures from -40°C to $+85^{\circ}\text{C}$ (-40°F to $+185^{\circ}\text{F}$).
- Pull loads up to max. 2,400Pa and push loads up to max. 5,400Pa (see chapter "Mounting Options").
- Installation using a mounting structure for solar modules.

Prevention of Shadowing Effects

Optimal solar irradiation leads to maximum energy output:

- For this reason, install the modules so that they face the sun.
- Avoid shadowing (due to objects such as buildings, chimneys or trees).
- Avoid partial shading (for example through overhead lines, dirt, snow).

Mounting Structure Requirements

The Modules shall be installed and operated on mounting structures that comply with any applicable laws and stipulations as well as with the following:

- Conform to the necessary structural requirements.
- Compliant with local snow and wind loads.
- Properly fastened to the ground, the roof, or the façade.
- Forces acting on the module are relayed to the mounting substructure.
- Ensures sufficient rear ventilation of the module.
- Avoid the usage of different metals to prevent contact corrosion.
- Allows for stress-free expansion and contraction due to temperature fluctuations.

- Ensure that no additional forces are applied through the mounting system into the module except for the wind and snow loads. Additional forces and moments of torque at the mounting positions caused by torsions, displacements or vibrations in the mounting system are not allowed.
- Ensure that the clamps and the mounting frame are compatible.

Clamp System Recommendations

Use customary clamps that satisfy the following requirements:

- Clamp width: ≥ 40 mm.
- Clamp height compliant with a 32mm frame height.
- Clamp depth: 7-12 mm. (applicable for all CL clamping mounting options at section "2.3 Mounting options")
- Clamps are not in contact with the front glass.
- Clamps do not deform the frame.
- Clamps that satisfy the structural requirements based on the conditions of the installation site according to the applicable regulations and technical standards.
- Long-term stable clamps that securely affix the module to the mounting frame.

Module Orientation Requirements

- Vertical or horizontal installation is permitted.
- Ensure that rain and melting snow can run off freely. No water accumulation.
- Ensure that the drainage holes in the frame are not covered. No sealing.

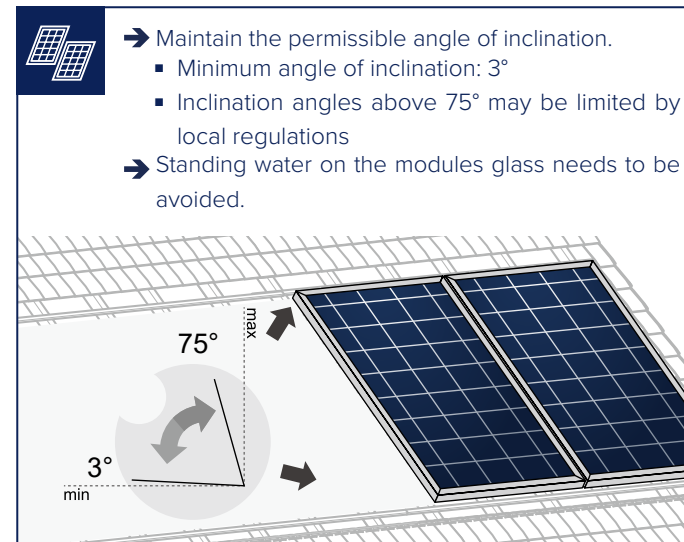

2 Planning

2.3 Mounting options

Fig. 2: Installation options for crystalline Qcells modules. All dimensions are given in mm. Also observe the maximum test loads and clamping range as specified on the following page. The illustrated installation options apply for both horizontal and vertical module orientation.

TYPE OF INSTALLATION	POINT MOUNTING SYSTEM	LINEAR MOUNTING SYSTEM
Installation with clamps		
Hybrid clamping		
Installation on mounting points		
Installation with insertion profiles	not permitted	

2 Planning

2.3 Mounting options

Installation Site

MOUNTING OPTION	POSITION OF CLAMPS* [MM]	TEST LOAD PUSH/PULL** [Pa]	DESIGN LOAD PUSH/PULL** [Pa]	SAFETY FACTOR
CL1a	300 - 550	5400/2400	3600/1600	1.5
	20 - 550	2000/2000	1330/1330	
CL3	300 - 550	3000/2400	2000/1600	
CL5	short side: 100 - 250 long side: 300 - 450	2400/2400	1600/1600	
FB1	373	5400/2400	3600/1600	
FB2	373	3000/2400	2000/1600	
IP1	-	3000/2400	2000/1600	

→ The below mounting options are only possible under certain conditions.

MOUNTING OPTION	POSITION OF CLAMPS* [MM]	TEST LOAD PUSH/PULL** [Pa]	DESIGN LOAD PUSH/PULL*** [Pa]	SAFETY FACTOR
CL2a	20 - 300	2400/1600	1600/1065	1.5
CL2b (without rails)	20 - 300	1700/1600	1130/1065	

* Distance between outer edge of module and middle of the clamp; consider further details below.

** Loads according to IEC 61215-2:2016 and UL 61730.

*** Test procedure according to IEC 61215-2:2016 and UL 61730. Loads for these mounting options do not fulfill the requirements of the standards.

2 Planning

2.3 Mounting options

MOUNTING OPTION	REQUIREMENTS
All	<ul style="list-style-type: none"> → The loads in the table are related to the mechanical stability of the solar modules. The mechanical stability of the mounting system including clamps has to be evaluated by the system supplier. The listed test load values have been determined with the following clamp parameters: clamp width = 40 mm and clamp depth = 10 mm. → The system installer is responsible for the determination of location-specific load requirements. → Ensure that the connection cables of the junction box do not run between laminate and mounting rails. → Modules bend under load. Therefore, sharp objects (e.g. screws, ballast stones, rail ends, rails with burrs or sharp corners) must not be placed near the module backside so as not to touch the laminate under load. → Ensure that the junction boxes do not touch the mounting structure (e.g. shorts rails, ballast, etc.) or the rooftop under load. Clamps or insertion profiles etc. must not touch the glass (even under load). → Unbalanced loads (e.g. snow overhangs, snowdrifts) which result in locally significantly increased loads must be removed or avoided by technical measures.
CL1a, CL2a, CL3, FB1, FB2	→ Ensure that module frame is fixed directly on the rail of the substructure (no spacer allowed between the module and substructure).
CL2b, CL3, FB2	→ A minimum support depth of 15mm is required on the back side of the module.
CL5	→ The minimum required support depth on the module backside is 10 mm on long frame side and 15 mm on short frame side.
IP1	→ Ensure minimum support depth of 15mm on the backside and 10mm on the front side of the module.
FB1, FB2	→ Use M8 corrosion-proof screws and washers (diameter ≥15.8 mm) for mounting slots (Detail A, Fig.1). Mounting screws and washers should have the same material properties.

2 Planning

2.4 Electrical layout

Module Selection

For detailed key electrical data, please refer to the actual data sheet referring to the relevant Module (available at www.qcells.com).

→ For maximum energy yields, mismatches of specified electric current (I_{MPP}) of more than 5 % should be avoided for all modules connected in series.

Safety Factor

During normal operation, a module may generate a greater current and/or higher voltage than that determined under standardized test conditions. Please use a safety factor of 1.25 for the following:

- Calculating the voltage measurement values (V_{oc}) of components
 - Calculating the current measurement values (I_{sc}) of conductors
 - Sizing of control systems connected to the outlets of the solar modules
- Please follow the valid national guidelines for the installation of electrical systems.

Series Connection

Connection of modules in series is only permitted up to the maximum system voltage as listed in the applicable data sheet of all the relevant modules to be installed.

→ Take into account all possible operating situations and all relevant technical norms and regulations when designing the system. It has to be ensured that the maximum system voltage, including all necessary safety margins, is not exceeded.

→ Take the voltage limit of the inverter into account when determining the maximum number of modules in the string.

Parallel Connection

Modules may be damaged by the occurrence of reverse currents (caused by module defects, ground leaks, or defective insulation).

→ Ensure that the maximum reverse current load capacity indicated in the data sheet is met.

In order to limit reverse currents that may occur, we recommend using the following safety options:

1) Layout with a limited number of parallel connected strings:

Without undertaking further current blocking measures, a maximum of two module strings may be operated in parallel on a single inverter or MPP tracker.

2) Layout with string fuses:

Use overcurrent devices (e.g. fuses) according to the relevant standards in each string. Use gPV-fuses according to IEC 60269-6. Observe the maximum permitted number of strings as indicated in the specifications provided by the respective string fuse manufacturer and the technical guidelines.

NOTE!

When installing different product versions, the lowest minimum permitted reverse current load capacity applies.

Inverters

Inverters with or without transformers may be used.

3 Installation

3.1 Safety and transport

 → Ensure that all personnel are aware of and adhere to accident-prevention and safety regulations.
→ While working wear clean gloves.



 **Danger! Risk of fatal injury due to electric shock!**
→ Do not install damaged modules.
→ Inform your distributor of any damages immediately.

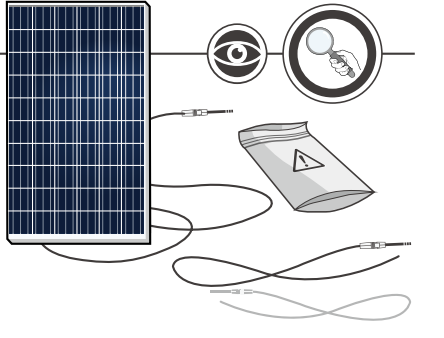

 → Inspect the packaging for damages.
→ Contact the transport company regarding any damage to the packaging and follow their instructions.
→ Follow any instructions on the packaging.



 **Warning! Fire Risk!**
→ Do not install modules indoors.
→ Do not install modules on moving objects.



 → Leave modules in their original packaging until installation.
→ Store the modules securely in cool and dry rooms. The packaging is not weatherproof.



3 Installation

3.1 Safety and transport

! **Note! Module damage may occur!**
→ Never lift or move the module with the connection cables or junction box.
→ Carry modules upright and horizontally as shown.

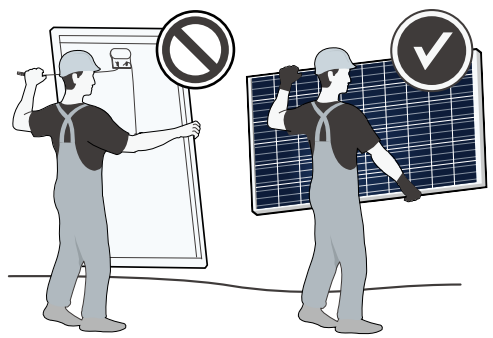

! **Note! Module damage may occur!**
→ Never step on modules.
→ Do not subject modules to any mechanical stress.
→ Do not allow any objects to fall onto modules

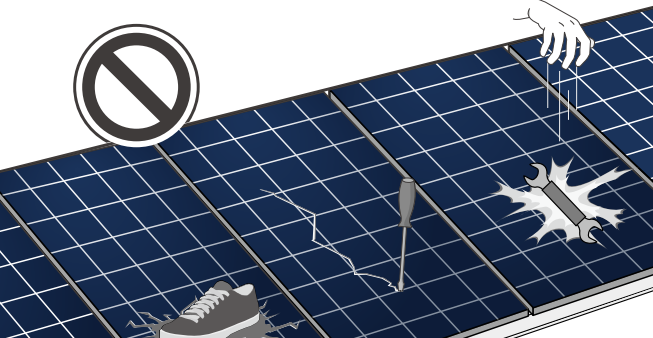

! **Note! Module damage may occur!**
→ Do not drop modules.

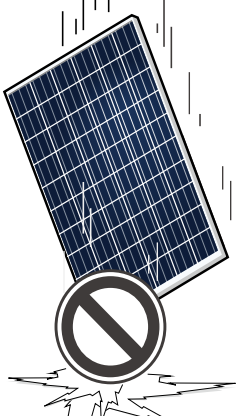

! **Note! Module damage may occur!**
→ Only make modifications to the module which have been confirmed in writing by Qcells.

qcells
confirmation
letter

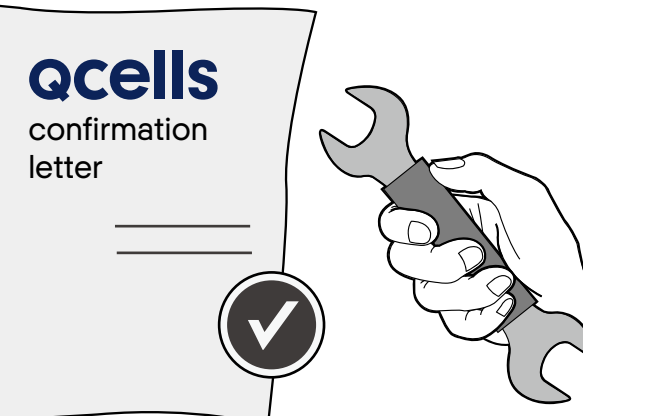

! **Note! Module damage may occur!**
→ Do not stack modules.

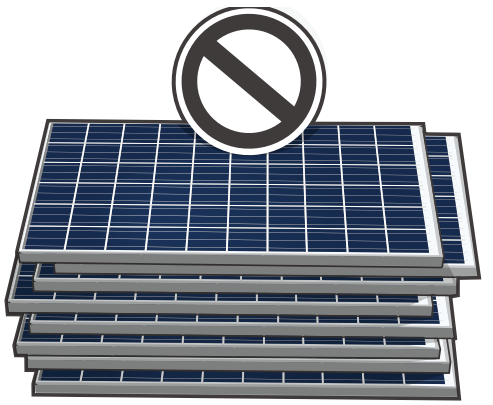

! **Note! Module damage may occur!**
→ Do not install modules near flammable gas/vapors.
→ Do not install modules in close proximity to air conditioning systems.

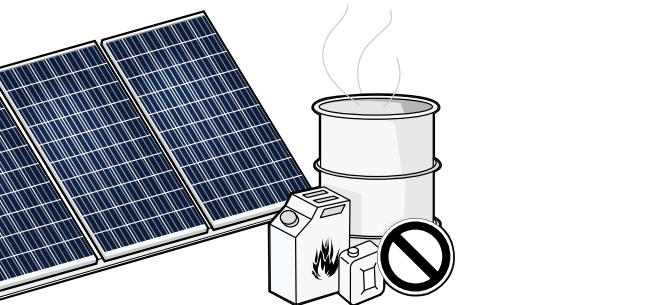

3 Installation

3.2 Preparation of installation

! **Danger! Risk of fatal injury due to electric shock!**
→ Block off the installation zone.
→ Keep children and unauthorized individuals away from the solar power system.

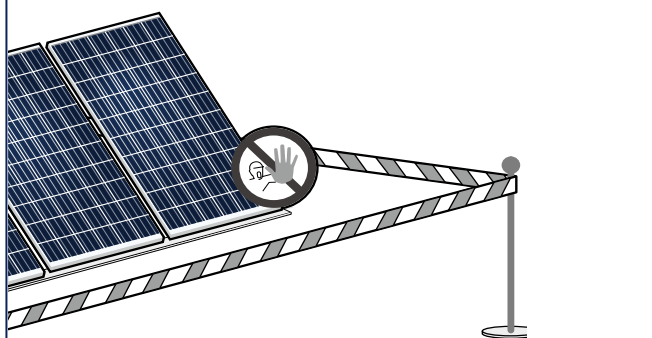

! **Warning! Risk of injury due to falling modules!**
→ Secure modules during installation.
→ Do not install modules in windy or wet weather.

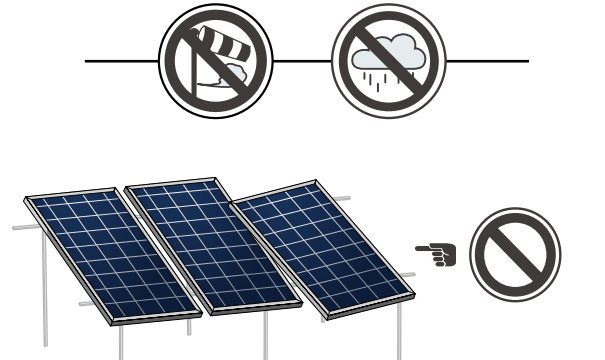

! **Danger! Risk of fatal injury due to electric shock!**
→ Only use dry, insulated tools.

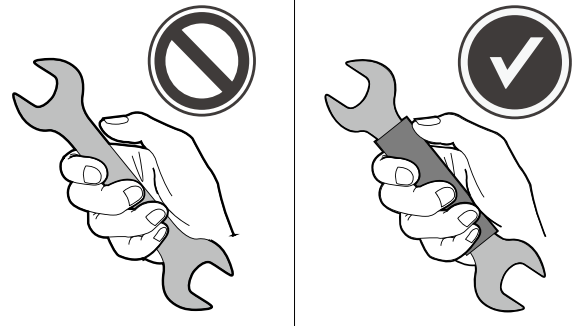

! → Do not carry out the installation alone.

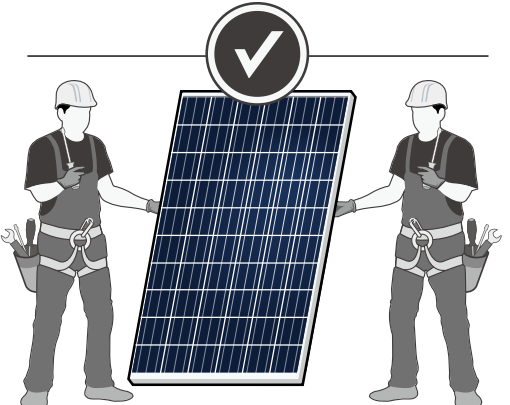

! **Danger! Risk of fatal injury due to electric shock!**
→ Ensure that modules and tools are not subject to moisture or rain at any time during installation.



! → Only install undamaged modules and components.
→ Do not modify the module (e.g. do not drill any additional holes).

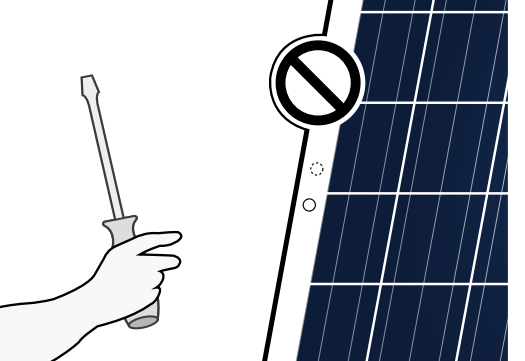

3 Installation

3.3 Module installation

Option 1:

- Fasten the module with 4 clamps in the specified clamping range, see Fig. 2, p. 7.
- Tighten clamps according to manufacturer's instructions.

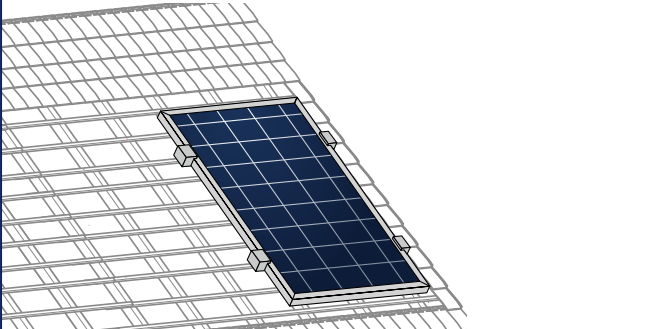

Option 1:

- Maintain an interval of at least 10 mm between two modules along the short side and 5 mm along the long side.

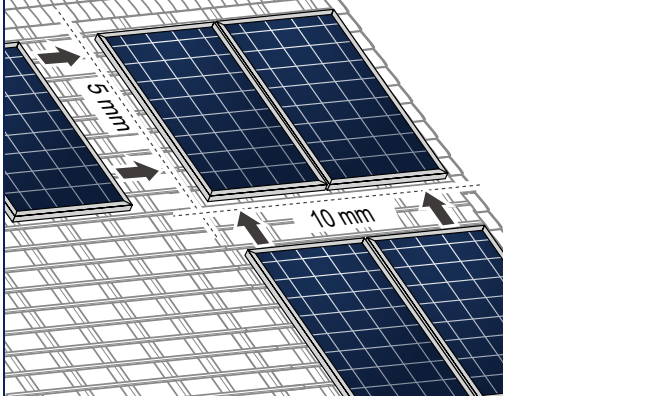

Option 2:

- Install the module at the 4 mounting points, see Fig. 2, p. 7.
- Tighten screws according to manufacturer's instructions.

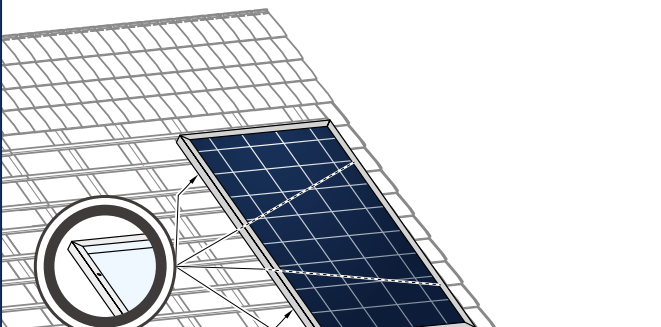

Note! Module damage may occur!

- Do not subject modules to mechanical tension. Max. torsion 10 mm/m.

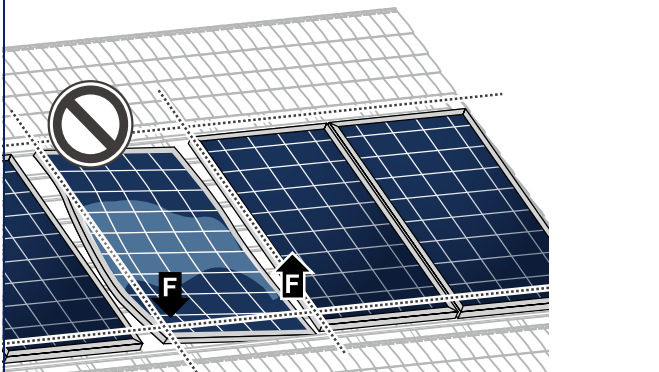

Option 3:

- Install the module using mounting profiles, see Fig. 2, p. 7.

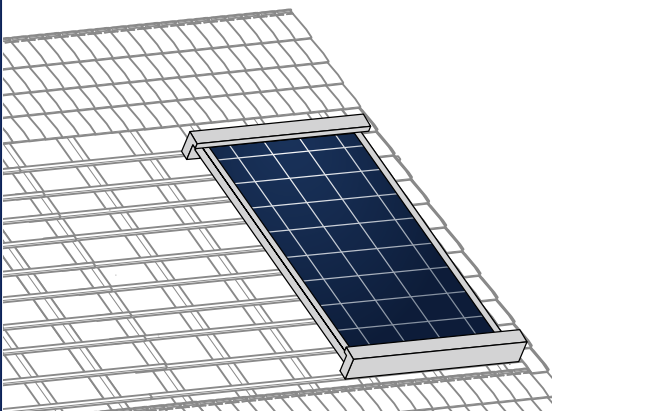

4 Electrical connection

4.1 Safety

Danger!
Risk of fatal injury due to electric shock!

When disconnecting an electric circuit carrying direct current, electric arcs can occur that may result in life-threatening injuries.

- Do NOT unplug the cable when under load.
- Do NOT connect any exposed cable ends.
- Electrical work may only be performed by qualified and skilled personnel (see page 3).

A solar module generates electrical current and voltage even at a low intensity of illumination. Sparks and electric arcs may result from the separation of a closed circuit. These can result in life-threatening injuries. The danger increases when several modules are connected in series.

- Please be aware of that the entire open circuit voltage is active even at low levels of solar irradiation.
- Please follow the valid national regulations and safety guidelines for the installation of electrical devices and systems.
- Please make sure to take all necessary safety precautions. With module or phase voltages of more than 120 V, the safety extra-low voltage range is exceeded.
- Carry out work on the inverter and the wiring with extreme caution.
- Ensure that the modules are disconnected at the inverter prior to separation.
- Be sure to observe the time intervals specified by the inverter manufacturer after switching off the inverter.
- Make sure that the plugs can not be connected unintentionally.
- Before working on the contacts, check them for safety extra-low voltage.

Danger! Risk of fatal injury due to electric shock!

- Never open the junction box.
- Do not remove bypass diodes.

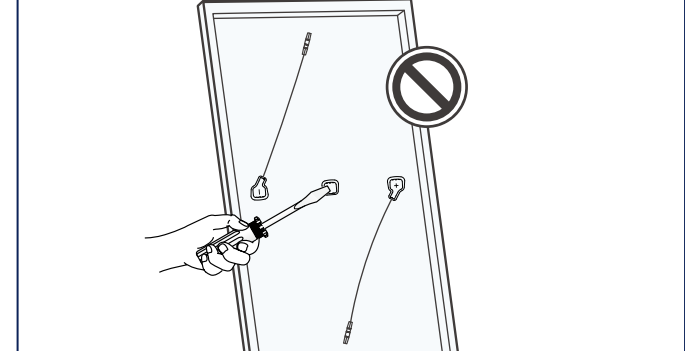

Danger! Risk of fatal injury due to electric shock!

- Never touch live contacts with bare hands.
- Cover connectors by suitable protective caps until installation.

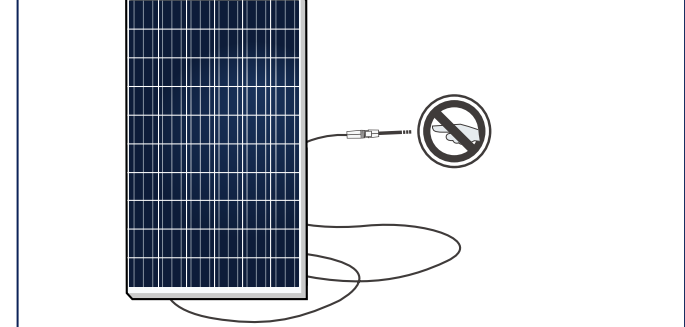

Danger! Risk of fatal injury due to electric shock!

- Only use dry, insulated tools for electrical work.

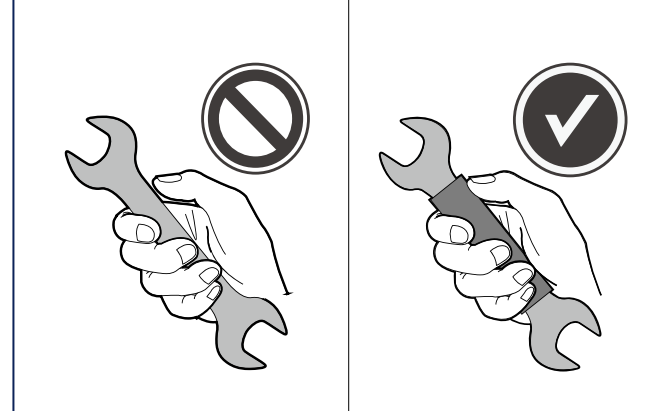

Danger! Risk of fatal injury due to electric shock!

- Insulate any exposed cable ends.
- Only connect cables with plugs.

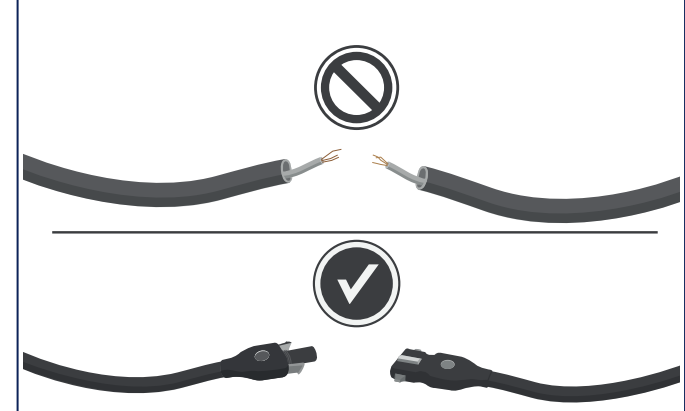

4 Electrical connection

4.2 Electrical installation safety

- ! Danger! Risk of fatal injury due to electric shock!**
- Electrical work may only be performed by qualified and skilled personnel (see page 3).
 - Ensure correct polarity.

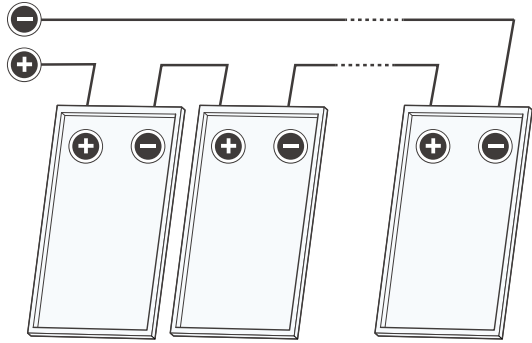

- ! Danger! Risk of fatal injury due to electric shock!**
- Never plug or unplug the cable when under load. Modules must not carry any current.
1. Switch off the inverter.

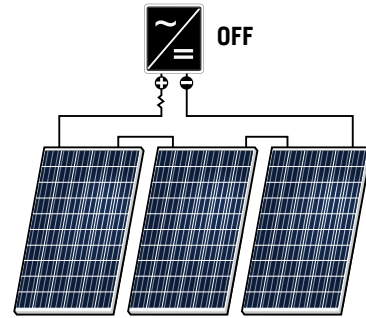

- ! Danger! Risk of fatal injury due to electric shock!**
- Be sure to maintain the time intervals as specified by the inverter manufacturer between switching off the inverter and beginning any further work.

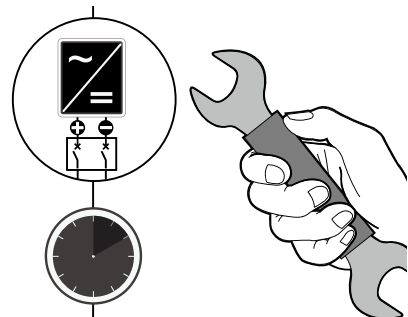

- ! Danger! Risk of fatal injury due to electric shock!**
2. Switch off the DC circuit breaker.
 3. Measure shutdown in DC String. (no DC current flow).
 4. Disconnect plugs by the use of appropriate and qualified tools of the manufacturer.
 5. When connecting the modules proceed in reverse order.

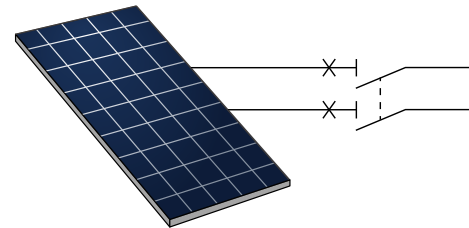

4 Electrical connection

4.3 Connection of modules

- ! Danger! Risk of fatal injury due to electric shock!**
- Use solar cables for the connection at the junction box outlet.
 - Only interconnect connectors of the same type and manufacturer.
 - Use minimum 4 mm² copper wires insulated for a minimum of 90 °C for field connections.

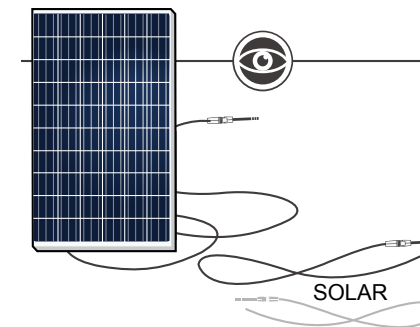

- ! Note! Module damage may occur!**
- Ensure that the cabling is not under mechanical stress (Comply with bending radius of ≥60 mm).
 - Ensure that the cables do not run between module and mounting rail or structure (danger of pinch).

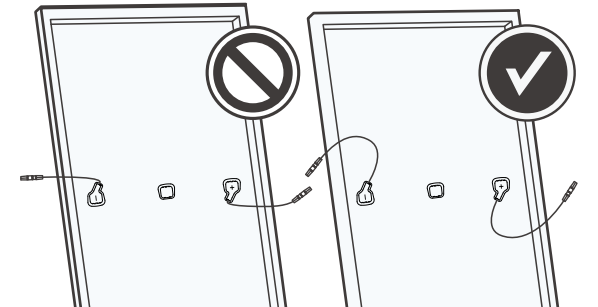

- ! Danger! Risk of fatal injury due to electric shock!**
- Ensure that all electrical components are in a proper, dry, and safe condition.

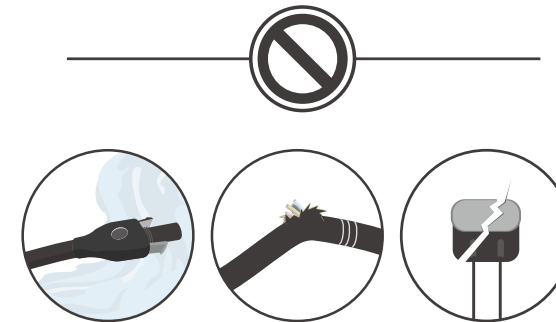

- ! Danger! Risk of fatal injury due to electric shock!**
- Do not connect modules with different orientations or angles of inclination in the same string.

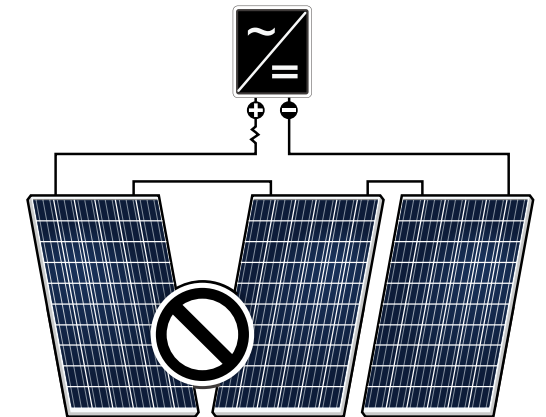

- ! Danger! Risk of fatal injury due to electric shock!**
- Ensure for a tight connection between the plugs. Plugs click together audibly.

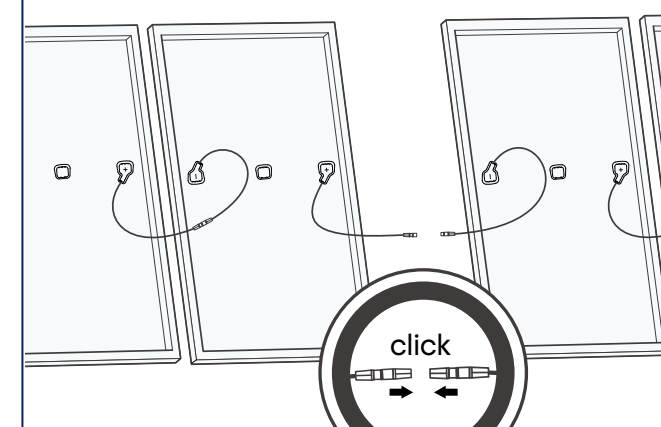

- ! Note! Module damage may occur!**
- To avoid complex cabling arrangements, it is often advantageous to rotate some modules 180°.
 - Module orientation can clearly be identified from the front side by the serial number and barcode labelled behind the module glass on the side with negative connection cable.

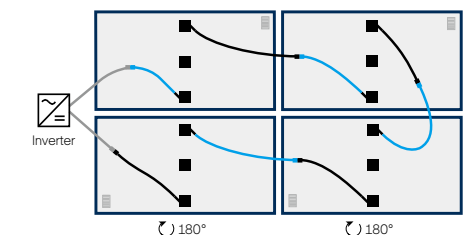

4 Electrical connection

4.4 After installation

 → Ensure that all necessary safety and functional tests have been carried out according to applicable standards.



 **Note! Module damage may occur!**
→ Ensure that the plug connections are secured away from any water-channelling surface.

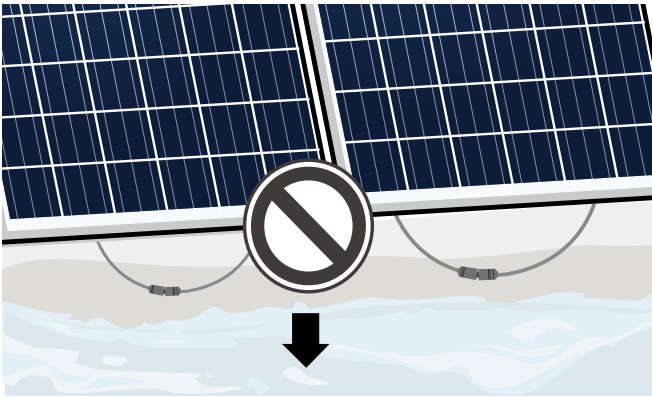

 → Integrate the system into the existing lightning protection system in accordance with the applicable local regulations.

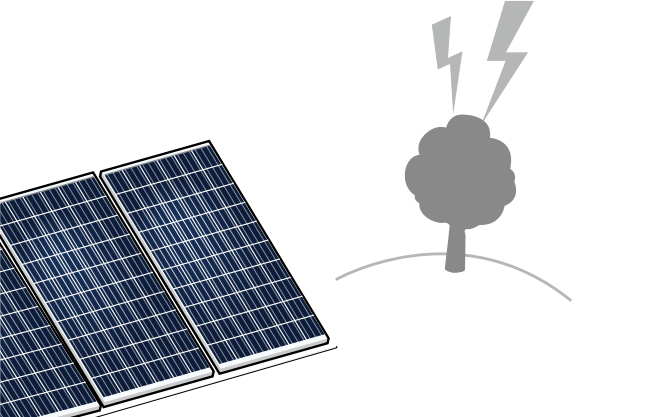

 **Warning! Fire Risk!**
→ Do not use light concentrators (e.g. mirrors or lenses).



 → Ensure that the cabling is not exposed and/or hanging and is protected from dirt, moisture and mechanical friction.

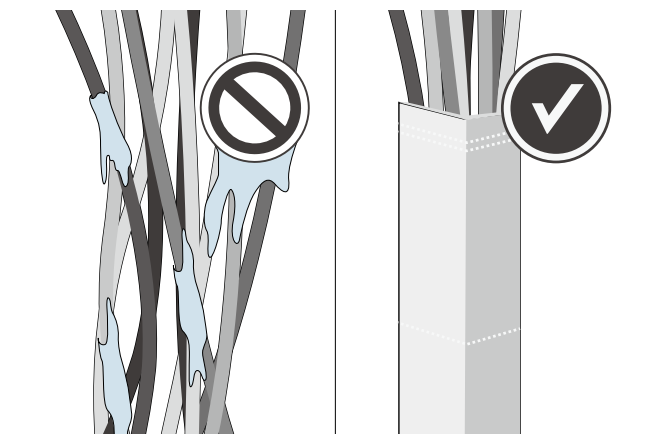

5 Grounding

Protective Grounding

→ The modules must be grounded in accordance with the local statutory regulations.

6 Faults and defects

 **Danger!**
Risk of fatal injury due to electric shock!

- Do not attempt to fix any problems yourself (e.g., glass cracks, damaged cables).
- Please contact an installer or Qcells Technical Customer Service Department.

7 Disposal

- Do not disconnect modules by yourself.
- Please contact an installer or Qcells Technical Customer Service Department.
- Dispose of modules in accordance with the local disposal regulations.

8 Maintenance and cleaning

Qcells solar modules are known for a long operating life and minimal maintenance effort and expense. Dirt and grime are usually washed away by rain. If the module is fully or partially shaded by dirt or debris (e.g., plants, bird droppings), it needs to be cleaned to prevent a loss of performance.

Maintenance

- The PV system has to be inspected regularly by certified personnel
- The time intervals and extent of the inspection can depend on local circumstances (e.g. salt, ammonia content in the air, high humidity etc.). The customer/operator must inform himself about time intervals and extend of necessary inspections.
- Inspections have to be performed especially after extraordinary events (e.g. storm, hail, high snow loads etc.)
- During the inspections it has to be checked that the components are secure, undamaged and clean

Cleaning



WARNING!

Risk of injury due to hot and live modules!

- Only clean modules that have cooled down.
- Do not carry or wear any electrically conductive parts.



WARNING!

Risk of falling due to unsecured access!

- Never access the installation area alone or without taking adequate security precautions.
- Please commission a trade specialist.



NOTE!

Module surface damage may occur!

- Remove snow and ice carefully without force (e.g. with a very soft broom).
- Do not scratch off dirt.
- Module cleaning has to be done by qualified personnel according to the state of the art and taking into account all relevant safety issues and general product properties, e.g., but not restricted to:
 - electrical safety
 - mechanical stability (load limits depending on the actual mounting options)
 - chemical suitability (no effect to any of the module's components, e.g. cable, connector, silicone)
 - no abrasive materials.



NOTE!

Dust and dirt are abrasive materials!

- The situation for each individual project (or type of dirt) must always be professionally evaluated.
- Wrong cleaning may cause damages such as, but not limited to, damages to the glass surface (e.g. scratches) and AR coating, power loss, delamination, loss of frame-to-laminate bond, reduced snow and wind load capability etc.

Apart from the above, each customer is free to choose the method of cleaning. However, possible damages, caused by the cleaning or related to the cleaning tools or agents shall not be covered by the module's Product and Performance Warranty. Therefore it is recommended to use only the tools and agents which have already been successfully tested and used with PV modules, to prevent possible damage.

Isopropyl alcohol (IPA) can be used selectively to remove stubborn dirt and stains within one hour after emergence.



Note! Module damage may occur!

- Do not clean modules with water if there is a risk of frost.

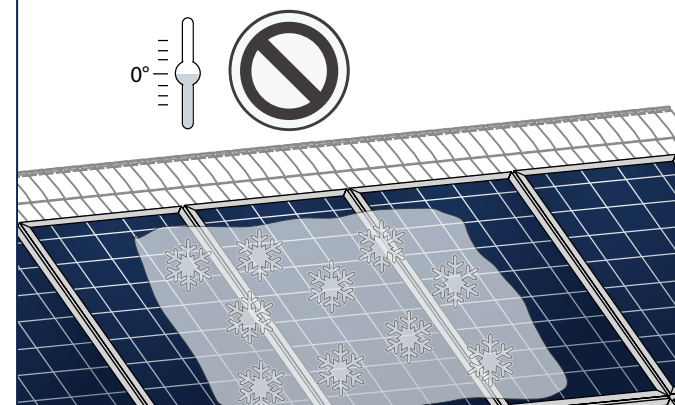

- Free the substructure from any dirt and debris (leaves, bird nests, etc.).

