

User Manual

LPBA48050-OH



LiFePO4 Battery System

Contents

- 1 Introduction** 1
- 2 Symbols**..... 1
- 3. Safety** 2
 - 3.1 Handling 2
 - 3.2 Installation 2
- 4. Response to Emergency Situations** 2
 - 4.1 Warning Labels..... 2
- 5. Product Information** 3
 - 5.1 Battery Module Specifications 3
 - 5.2 BMS Specifications 4
 - 5.3 Battery System Specifications 4
- 6. Product Features**5
 - 6.1 Battery System Features 5
 - 6.2 Electrical Interface Description of BCU600050 5
 - 6.3 Electrical Interface Description of LPBA48050-OH 6
 - 6.4 System Wiring Schematic 6
 - 6.5 Switch On / Off 7
 - 6.6 Description for Communication port..... 7
- 7. Installation** 8
 - 7.1 Items in the package 9
 - 7.2 Product size information..... 9
 - 7.3 Tools..... 9
 - 7.4 Floor installation with base..... 9
 - 7.5 Wall-Mounted Installation Process 11
 - 7.6 Install Environment 12
 - 7.7 Terminal Connection 12
 - 7.8 Battery system switch operation 13
 - 7.9 Commissioning 13
- 8. Commissioning** 14
- 9. Exclusion** 14
 - 9.1 Maintenance 14
 - 9.2 Troubleshooting 15











1. INTRODUCTION

The document describes the installation, commissioning, maintenance and troubleshooting of the following high voltage battery listed below.

The battery chemistry of these products is Lithium Iron Phosphate. This manual is designed for qualified personnel only. The tasks described in this document should be performed by authorized and qualified technicians only.

After Installation the Installer must explain the user manual to the end user.

2. SYMBOLS

	Caution, risk of electric shock.
	Do not place nor install near flammable or explosive materials.
	Install the product out of reach of children.
	Read the instruction manual before starting installation and operation.
	Do not dispose of the product with household wastes.
	Recyclable.
	Disconnect the equipment before carrying out maintenance or repair.
	Observe precautions for handling electrostatic discharge sensitive devices.
	Protective Class 1.
	Caution, risk of electric shock, energy storage timed discharge.

SPECIFICATIONS FOR BCU600050

The battery system main using Solar power system for Family house. It also have a with to controller the battery easily and protect our Household application timely.

3.1 Handling

- Do not expose battery to open flame.
- Do not place the product under direct sunlight.
- Do not place the product near flammable materials. It may lead to fire or explosion in case of accident.
- Store in a cool and dry place with ample ventilation.
- Store the product on a flat surface.
- Store the product out of reach of children and animals.
- Do not damage the unit by dropping, deforming, impacting, cutting or penetrating with a sharp object. It may cause leakage of electrolyte or fire.
- Do not touch any liquid spilled from the product. There is a risk of electric shock or damage to skin.
- Always handle the battery wearing the insulated gloves.
- Do not step on the product or place any foreign objects on it. This can result in damage.
- Do not charge or discharge damaged battery.

3.2 Installation

- After unpacking, please check the product for damages and missing parts.
- Make sure that the inverter and battery is completely turned off before commencing installation.
- Do not interchange the positive and negative terminals of the battery.
- Ensure that there is no short circuit of the terminals or with any external device.
- Do not exceed the battery voltage rating of the inverter.
- Do not connect the battery to any incompatible inverter.
- Do not connect different battery types together.
- Please ensure that all the batteries are grounded properly.
- Do not open the battery to repair or disassemble. Only Felicity is allowed to carry out any such repairs.
- In case of fire, use only dry powder fire extinguisher. Liquid extinguishers should not be used.
- Install the battery away from children or pets.
- Do not use battery in high static environment where the protection device might be damaged.
- Do not install with other batteries or cells.

4. RESPONSE TO EMERGENCY SITUATIONS

The batteries comprise of multiple batteries connected in series. It is designed to prevent hazards or failures. However, Felicity cannot guarantee their absolute safety. Under exposure to the internal materials of the battery the following recommendations should be carried out by the user.





- If there has been inhalation, please leave the contaminated area immediately and seek medical attention.
- If there has been contact with eyes, rinse the eyes with running water for 15 minutes and seek medical attention immediately.
- If there has been contact with the skin, wash the contacted area with soap thoroughly and seek medical attention immediately.
- If there has been ingestion, induce vomiting and seek medical attention.





Fire Situation

Use a FM-200 or Carbon Dioxide (CO2) fire extinguishers to extinguish the fire if there is a fire in the area where the battery pack is installed. Wear a gas mask and avoid inhaling toxic gases and harmful substances produced by the fire.

4.1 Warning Labels

Warning labels and other relevant labels are attached on the battery pack.

 High Voltage Battery System <small>Made 100% off of steel</small>	
High Voltage Controller Model	BCU600050
Recommend Current	25A
Max Current	50A
Nominal Capacity	50Ah
Enclosure Protection Rating	Ip65
Working Temperature Range	-10°C~+50°C
  	

 Lithium Ion Battery <small>Made 100% off of steel</small>	
Model	LPBA48050-OH
Nominal Voltage	51.2V
Nominal Capacity	50Ah
Nominal Energy	2560Wh
Enclosure Protection Rating	Ip65
Working Temperature Range	-10°C~+50°C
  	

WARNING

- Do not disassemble or alter the Pack to avoid heating up, explosion or fire.
- Do not use the Pack beyond specified conditions. Or it may cause heating up, damage or degrading its performance.
- Do not throw, drop, hit, drive-in nail, stamp on the Pack. Or it may cause heating up, explosion or fire.
- Do not put the Pack into fire. Do not use or leave it at the places near fire, heater or high temperature sources. Or it may cause over temperature, explosion or fire.
- Do not put the Pack into the water or wet it. Or it may cause heating up, explosion or fire.
- Do not connect the Pack's positive(+) and negative(-) terminal reversely. Or it will cause short circuit, explosion or fire.
- Do not connect the Pack's positive(+) and negative(-) terminal together or to any other metals. Or it will cause short circuit, explosion or fire.
- Take care! This Pack is heavy enough to cause serious injury.
- In case of electrolyte leakage, keep leaked electrolyte away from eyes or skin. If it has touched your eyes, please wash it with plenty of water and go to the hospital immediately.
- Keep out of the reach of children and animals.



5. PRODUCT INFORMATION

1. LPBA48050-OH is a battery module, it needs to be used with BCU600050 controller;
2. BCU600050 is the controller of the whole system, so each system must have one BCU600050;
3. Our system consists of at least 2 LPBA48050-OH + 1 BCU600050 and up to 10 LPBA48050-OH + 1 BCU600050.

5.1 Battery Module Specifications

Specifications For LPBA48050-OH	
Battery Module	LPBA48050-OH
Total Energy [Kwh]	2.56
Nominal Voltage [V]	51.2
MAX. Charge Voltage [V]	57.6
MIN. Discharge Voltage [V]	48
Max. Chargeing Current [A]	25
Max. Discharge Current [A]	25
Communication	CAN,RS485
Enclosure Protection Rating	Ip65
Working Temperature Range [°C]	-10 ~ 50
Cycle Life	> 6000 Cycle@ 80% DOD / 25°C
Net Weight(KG)	30.5±1
Gross Weight(KG)	34.5±1
Product Dimension(MM)	523*355*210
Package Dimension(MM)	642*422*363

5.2 BMS Specifications

SPECIFICATIONS FOR BCU600050	
Model No.	BCU600050
Operating Voltage Range(v)	80-576
Max. Charge/discharge Current (a)	25
Total Voltage Measurement Accuracy	±1.0%FSR
Communication	CAN,RS485
Available Soc Range	10%~100%
Charge/discharge Efficiency (%)	>98
Working Temperature Range [°C]	-10 ~ 50
Weight (kg)	12±1
Dimension [W X D X H, MM]	540/322/210
Product Dimension(MM)	523*355*210
Package Dimension(MM)	642*422*363
Net Weight(KG)	30.5±1
Gross Weight(KG)	34.5±1

5.3 Battery System Specifications

SPECIFICATIONS FOR BATTERY SYSTEM					
BATTERY SYSTEM	LPBA-5.1-OH	LPBA-7.7-OH	LPBA-10.2-OH	LPBA-12.8-OH	LPBA-15.4-OH
Battery Module	LPBA48050-OH(2.56kwh,51.2v)				
Number of Modules	2	3	4	5	6
Total Energy [Kwh]	5.12	7.68	10.24	12.8	15.36
Usable Energy [kWh] (90%DOD)	4.6	6.9	9.2	11.5	13.8
Nominal Voltage [V]	102.4	153.6	204.8	256	307.2
MAX. Charge Voltage [V]	115.2	172.8	230.4	288	345.6
MIN. Discharge Voltage [V]	96	144	192	240	288
Weight [Kg]	73.5	104	134.5	165	195.5
Battery Module	LPBA-17.9-OH	LPBA-20.5-OH	LPBA-23.0-OH	LPBA-25.6-OH	
Number of Modules	7	8	9	10	
Total Energy [KWh]	17.92	20.48	23.04	25.6	
Usable Energy [kWh] (90%DOD)	16.1	18.4	20.7	23	
Nominal Voltage [V]	358.4	409.6	460.8	512	
MAX. Charge Voltage [V]	403.2	460.8	518.4	576	

MIN. Discharge Voltage [V]	336	384	432	480
Weight [Kg]	226	256.5	287	317.5
Dimension [W x D x H, mm]	540/322/320+210×N			
Max. Chargeing Current [A]	25			
Max. Discharge Current [A]	25			
Communication	CAN, RS485			
Enclosure Protection Rating	Ip65			
Working Temperature Range [°C]	-10 ~ 50			
Cycle Life	>6,000 Cycle@ 80% DOD / 25°C / 0.5C, 60%EOL			
Warranty	5 years			
Certification	IEC62619,UN38.3,CE			

6. ELECTRICAL CONNECTIONS

6.1 Battery System Features

The batteries have been fitted with multiple protection systems to ensure the safe operation of the system. Some of the protection system includes:

- Inverter interface protection: Over voltage, Over current, External Short Circuit, Reverse Polarity, Ground Fault, Over Temp, In rush current.
- Battery Protection: Internal Short Circuit, Over voltage, over current, over temp, Under voltage The battery system contains the following Interface to allow it to connect and operate efficiently.

6.2 Electrical Interface Description of BCU600050

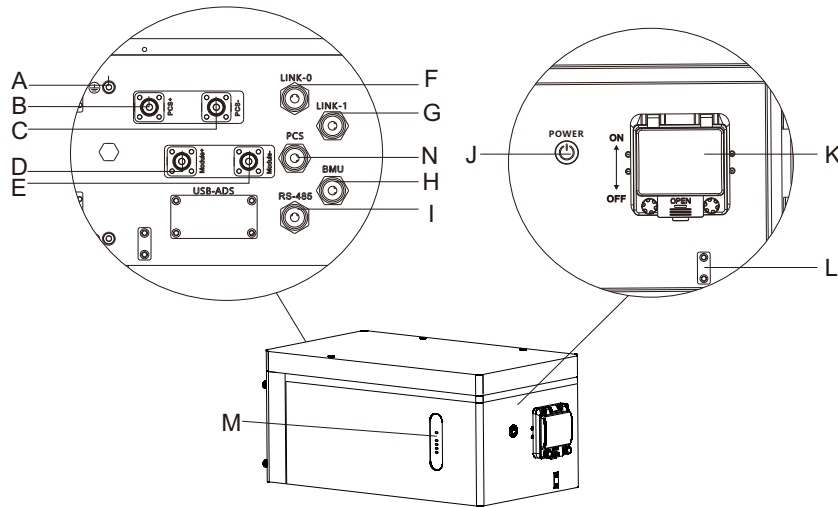

Code	Name
A	Earth Terminal
B	PCS +
C	PCS -
D	BAT +
E	BAT -
F	LINK-0
G	LINK-1
H	RS485 Communication
I	BMU Communication
J	Power Switch
K	Breaker
L	Fastener
M	LED display
N	PCS Communication

6.3 Electrical Interface Description of LPBA48050-OH

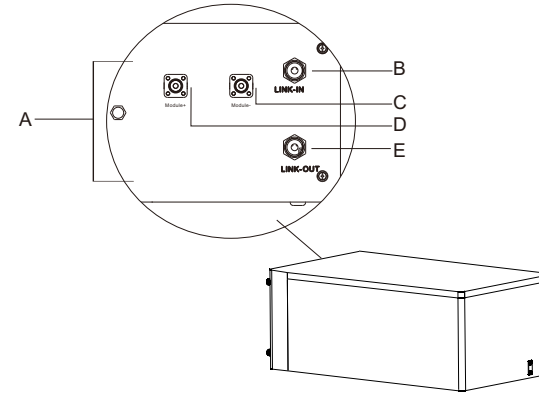

Code	Name
A	Earth Terminal
B	LINK_IN
C	BAT -
D	BAT +
E	LINK_OUT

6.4 System Wiring Schematic

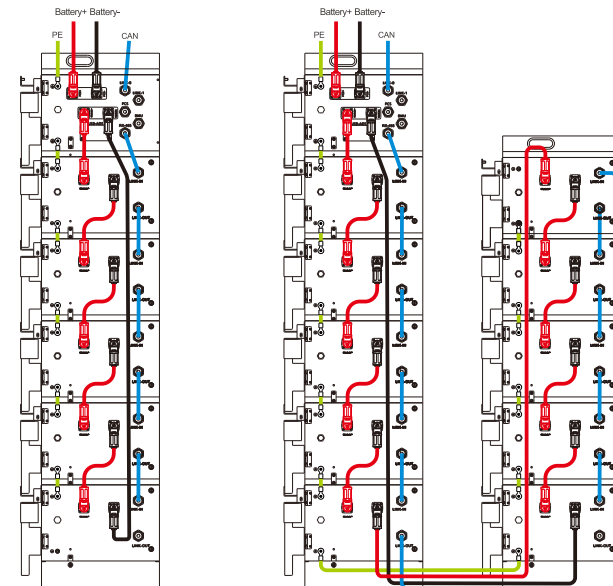

Note:

If the system is connected to less than or equal to 5 batteries, follow the diagram on the left.
If the system is connected to 5 or more batteries, please follow the diagram to the right.

6.5 Switch On / Off

Switch on: close the breaker to the ON block, press and hold Power switch for 2-3 seconds, the battery will perform self-test before output. The LED will show SOC.
Switch off: close the breaker to the OFF block, the battery will shut down directly.

6.6 Description for Communication port

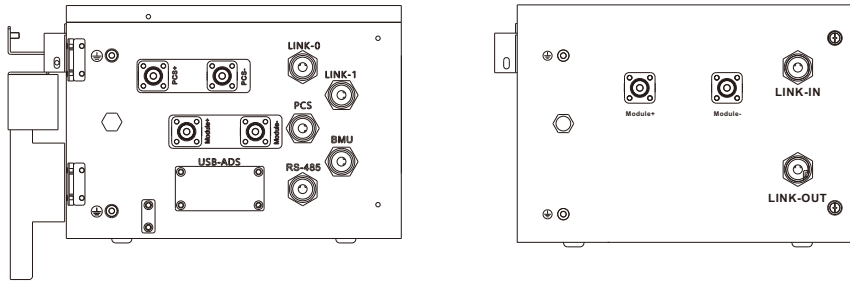

LINK-0 / LINK-1

Pin	Function Definitions	Function Declaration
1	GND	Power/signal ground
2	NC	
3	NC	
4	NC	
5	485B	RS485-B_PCS
6	485A	RS485-A_PCS
7	CANL	CANL_PCS
8	CANH	CANH_PCS

RS-485

Pin	Function Definitions	Function Declaration
1	GND	Power/signal ground
2	12V	
3	NC	
4	NC	
5	485B	RS485-B
6	485A	RS485-A
7	NC	
8	NC	

7. INSTALLATION

7.1 Items in the package

Please check if following items are including with the package:

FOR BCU600050

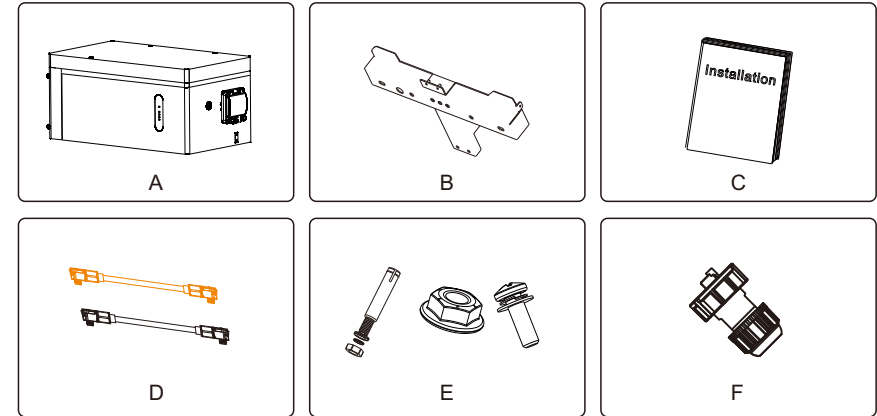

Code	Items	Code	Items
A	BCU600050	D	Power cable (to battery)
B	Wall bracket	E	Expansion screw / flange nut
C	User manual	F	Plug

FOR LPBA48050-OH

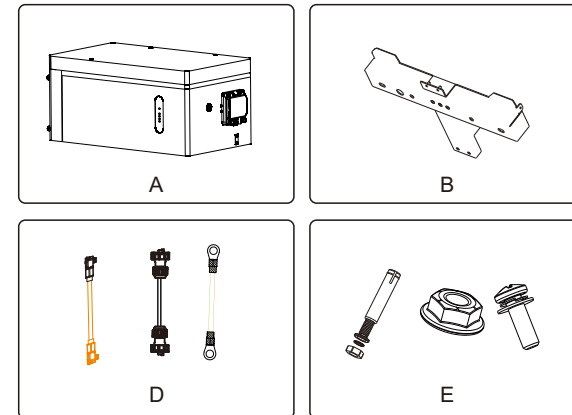

Code	Items	Code	Items
A	LPBA48050-OH	D	Serial cable
B	Wall bracket	E	Expansion screw / flange nut

7.2 Product size information

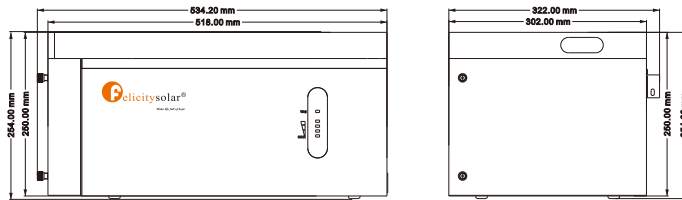

7.3 Tools

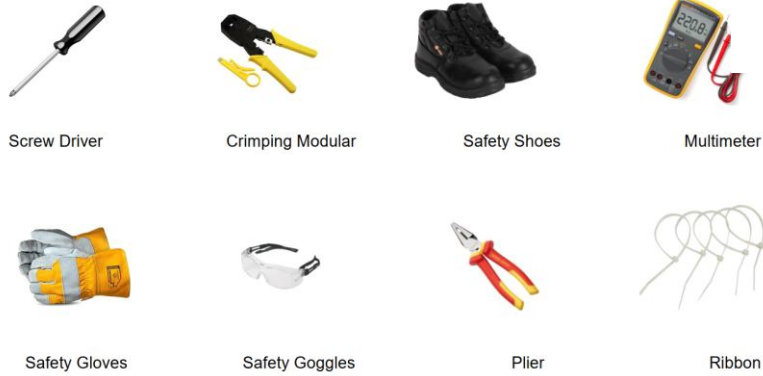

7.4 Floor installation with base

Installation Location Requirements

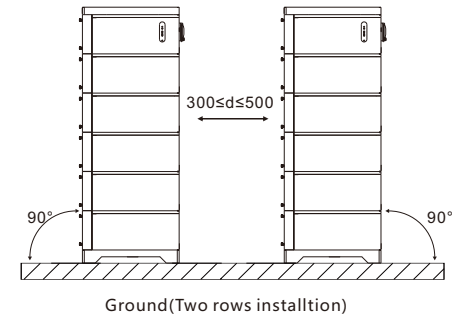
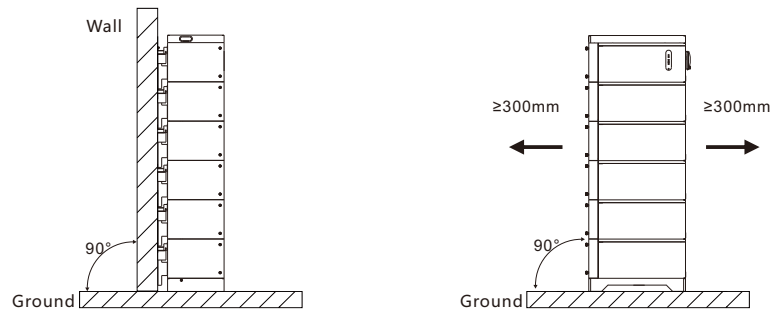

Installation Procedure

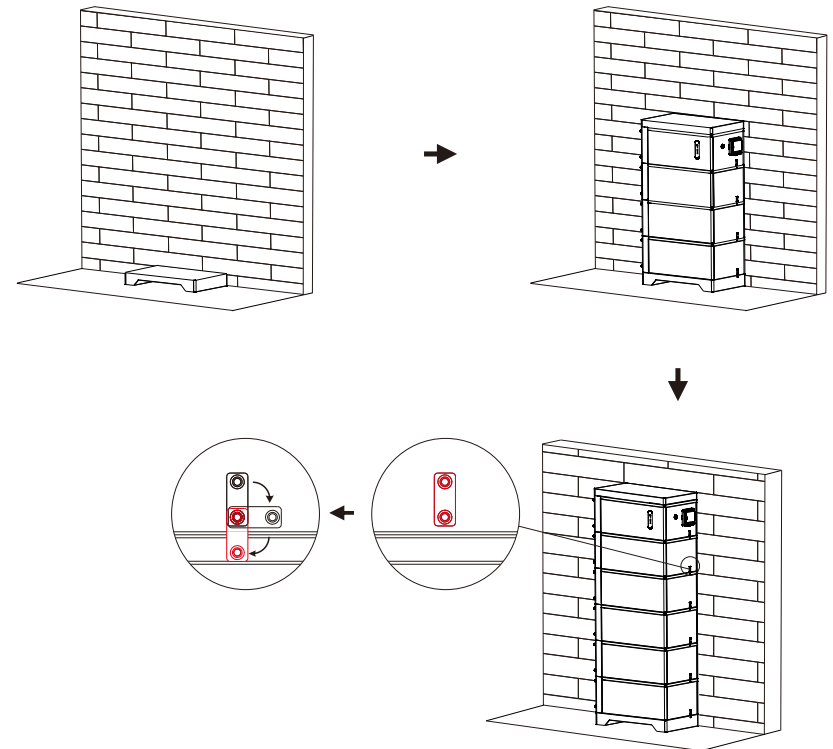

- Note:**
1. If more than 4 batteries are used, base mounting is recommended.
 2. For floor installation with base, the maximum stack number of the battery is ten. But if the battery number is greater than six, we recommend stacking them in two lines.

7.5 Wall-Mounted Installation Process

Installation Location Requirements

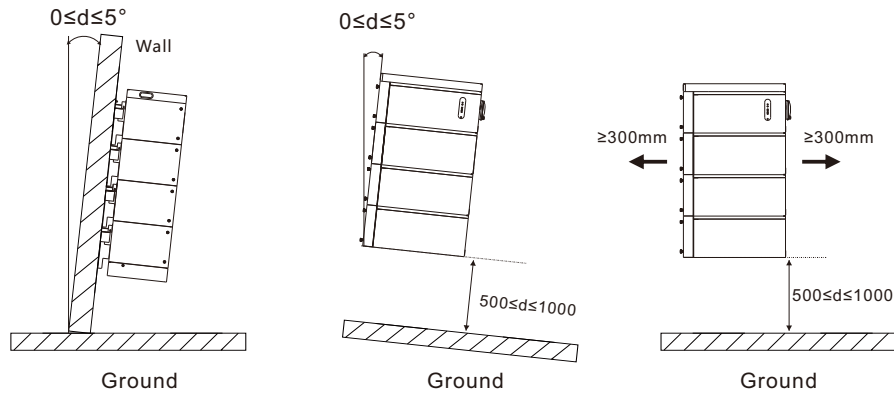

Installation Procedure

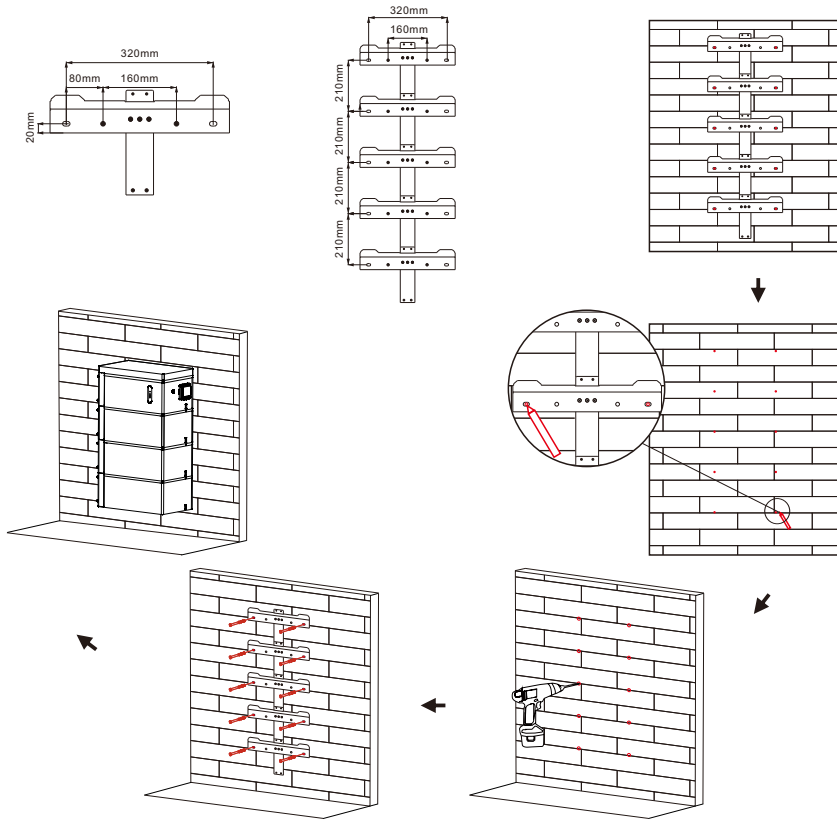

Note:

1. The number of wall-mount installations should not exceed four.
 2. Please make sure that the weight capacity of wall should exceed 150kg.
- Install Environment

7.6 Install Environment

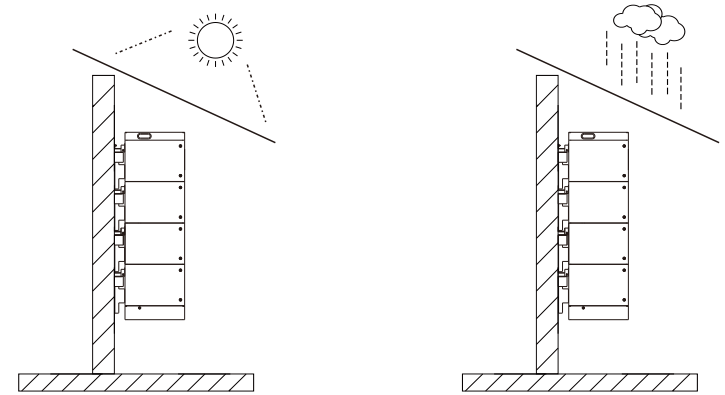

Note: Build sun & rain shade to avoid direct exposure to sunlight and rain.

7.7 Terminal Connection

Power terminal

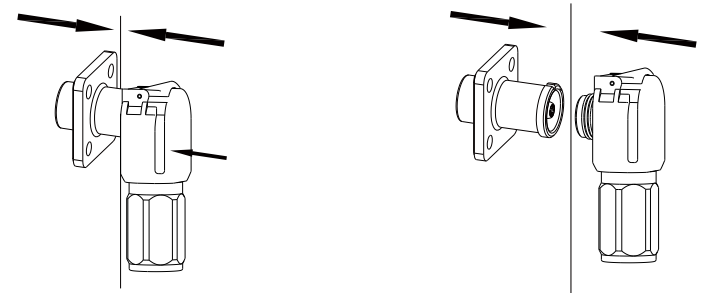

Note: Press the position indicated in the figure above before disconnecting the power terminal.

Communication terminal

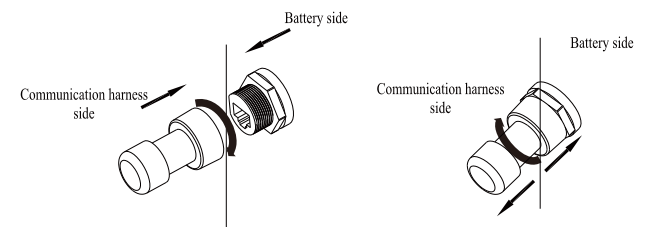

7.8 Battery system switch operation

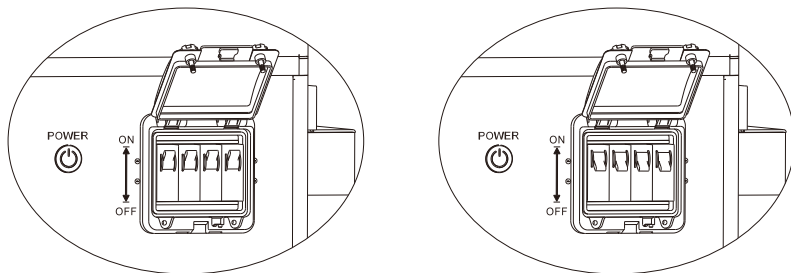

Power on battery system:

Turn the breaker to the "ON" state, press the POWER button 2-3 seconds, wait for the battery system LED light to light up, indicating that the boot is complete.

Power off battery system:

Turn the breaker to the "OFF" state, turn off the entire battery system.

7.9 Commissioning

There are five LED indicators on the front of the battery packs to show its operating status.

SOC LED indication

Status	●	Charge	DisCharge
= 100%	●	ON	ON
	●	ON	ON
	●	ON	ON
	●	ON	ON
100% > SOC ≥ 75%	●	RUNNING	ON
	●	ON	ON
	●	ON	ON
	●	ON	ON
75% > SOC ≥ 50%	●	RUNNING	OFF
	●	RUNNING	ON
	●	ON	ON
	●	ON	ON
50% > SOC ≥ 25%	●	RUNNING	OFF
	●	RUNNING	OFF
	●	RUNNING	ON
	●	ON	ON
25% > SOC ≥ 10%	●	RUNNING	OFF
	●	RUNNING	OFF
	●	RUNNING	OFF
	●	RUNNING	ON
10% > SOC > 0	●	RUNNING	OFF
	●	RUNNING	OFF
	●	RUNNING	OFF
	●	RUNNING	FLASH

SOC LED fault message

Status	Fault LED	SOC				Remark
		LED1	LED2	LED3	LED4	
Power On	On	ON	ON	ON	ON	Soft Start Failed
Standby/soft Start	Flash			Flash		Press Soc To Flash
Discharging	Off					Soc
Charging	Off					Running
Fault	ON	ON	OFF	OFF	OFF	Battery Voltage High
		OFF	ON	OFF	OFF	Battery Voltage Low
		ON	ON	OFF	OFF	Cell Voltage High
		OFF	OFF	ON	OFF	Cell Voltage Low
		ON	OFF	ON	OFF	Charging Current High
		OFF	ON	ON	OFF	Discharging Current High
		ON	ON	ON	OFF	Bms Temperature High
		OFF	OFF	OFF	ON	Bms Temperature Low
		ON	OFF	OFF	ON	Cell Temperature High
		OFF	ON	OFF	ON	Cell Temperature Low
		ON	ON	OFF	ON	Current Sesor Abnormal
		OFF	OFF	ON	ON	Soft Start Failed
		ON	OFF	ON	ON	Parallel Fault
		OFF	ON	ON	ON	Output Impedance Low
		Upgrade	Flash			OFF

8. WARRANTY

The warranty shall not cover the defects caused by normal wear and tear, inadequate maintenance, handling, storage faulty repair, modifications to the battery or pack by a third party other than Felicity, failure to observe the product specification provided herein or improper use or installation, including but not limited to the following.

Damage during transport or storage.

- Incorrect Installation of battery into pack or maintenance.
- Use of battery pr pack in inappropriate environment.
- Improper, inadequate, or incorrect charge, discharge or production circuit other than stipulated herein.
- Incorrect use or inappropriate use.
- Insufficient ventilation.
- Ignoring applicable safety warnings and instructions.
- Altering or attempted repairs y unauthorized personnel.
- In case of force majeure (ex: lightning, storm, flood, fire, earthquake, etc.).
- There are no warranties-implied or express-other than those stipulated herein. Felicity shall not be liable for any consequential or indirect damages arising or in connection with the product specification, battery or pack.

9. TROUBLESHOOTING AND MAINTENANCE

9.1 Maintenance

- 1.Regularly check whether the service environment of the battery meets the requirements, and the installation position should be far away from the heat source.
- 2.In case of one of the following situations, it needs to be charged in time:
 - The battery is often under charged;
 - The battery has been out of use or stored for more than 3 months.
- 3.Regularly check whether the battery and its supporting terminals, connecting cables and indicator lights are normal.

9.2 Troubleshooting

When the red / green LED on the panel is flashing or normally on, it does not mean that the Battery system is abnormal, it may be just an alarm or protection. Please check the 'LED fault message' in chapter 7 for the detailed faulty definition before any trouble-shooting steps. In general, the alarm indication is normal without manual intervention. When the alarm triggering state is removed, Battery system will automatically return to normal use.

- Problem determination based on the following points

- Whether the red light on the BCU600050 is on;
- Whether the battery can be output voltage or not.
- Whether the battery system can be communicated with inverter;

- Preliminary determination steps

LiFePO4 Battery System for Households Battery system cannot work, when DC switch on and POWER on, the LED doesn't light up or flash, please consider contact the local distributor.

- The LED display of BCU600050 is normal, but it cannot charge and discharge. Observe the display screen of inverter and there is no SOC. Please check whether the CAN communication between BCU600050 to inverter is well connected. If the connection is good, please replace a CAN communication cable. If the SOC is still not visible on the inverter display screen, please contact the local distributor.
- After the battery system is powered on, if you can see the alarm information on the LED and inverter display screen at the same time, please contact the local distributor.