

# SUN2000-(600W-P, 450W-P2) Smart PV Optimizer

## Quick Guide

**Issue: 02**

**Part Number: 31500GLF**

**Date: 2022-02-20**

HUAWEI DIGITAL POWER TECHNOLOGIES CO., LTD.



**HUAWEI**

# 1 Product Overview

The Smart PV Optimizer is a DC-DC converter installed on the rear of PV modules in a PV system. It manages the maximum power point (MPP) of each PV module to improve the energy yield of the PV system, and performs functions such as module-level shutdown and module-level management.

## SUN2000-600W-P (Short Input Cable)/SUN2000-450W-P2

The length of the input power cable delivered with the optimizer is 150 mm. Select PV modules with appropriate cable length to ensure that the optimizer can connect to PV modules.

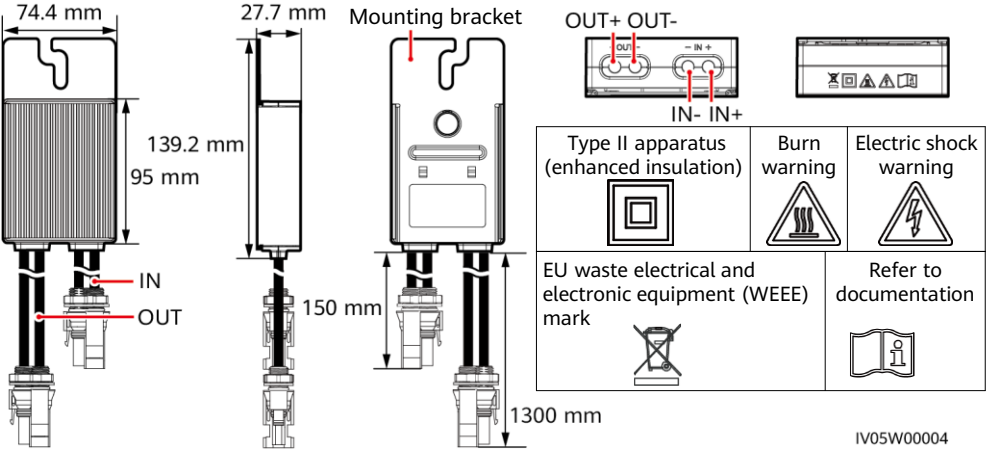

## SUN2000-600W-P (Long Input Cable)

The length of the input power cable delivered with the optimizer is 1000 mm. Select PV modules with appropriate cable length to ensure that the optimizer can connect to PV modules.

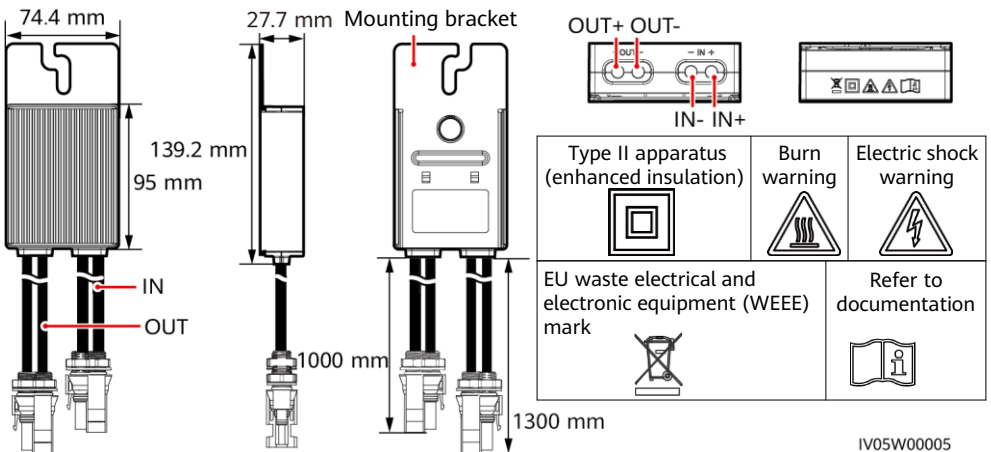

## 2 Installing the Device

### 2.1 Installation Requirements

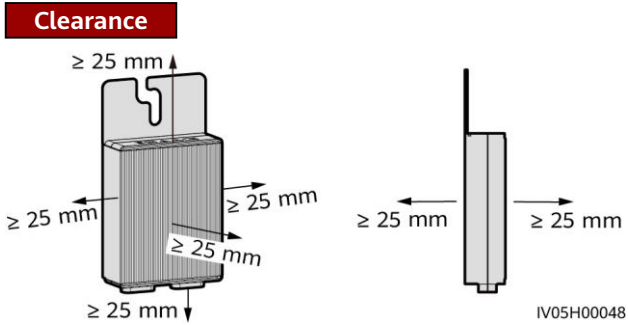

1. Do not install the optimizers in a position that might be soaked in water for two hours or longer.

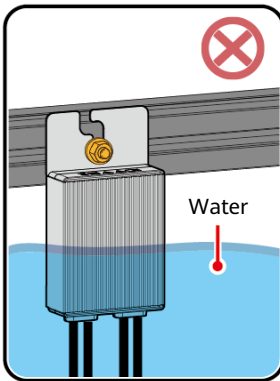

2. Improper operations during the installation and running of optimizers may cause fire. Do not store flammable or explosive materials in the installation area.

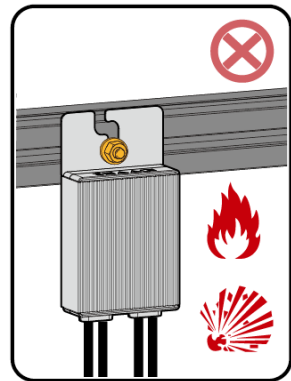

3. Do not cut the cables delivered with the optimizers. Otherwise, the warranty will be voided.

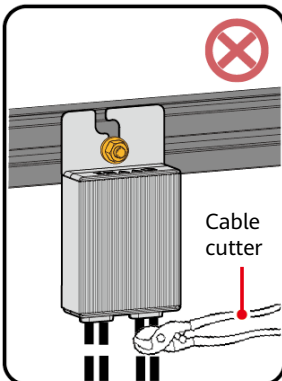

4. Avoid direct sunlight.

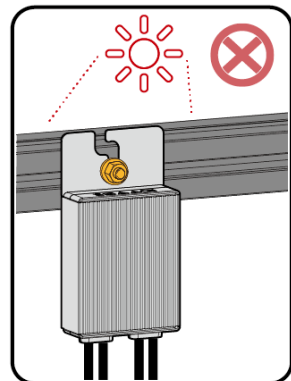

## 2.2 Installing the Optimizer

### NOTICE

Properly plan the installation position of optimizers to ensure that the cables between the optimizer and the PV module and between adjacent optimizers can be properly connected, and the maximum communication distance between the optimizer and the solar inverter is within 350 m.

1. After determining the installation position of the optimizer, remove the SN label from the optimizer and attach it to the physical layout template. For details, see instructions on the back of the physical layout template.

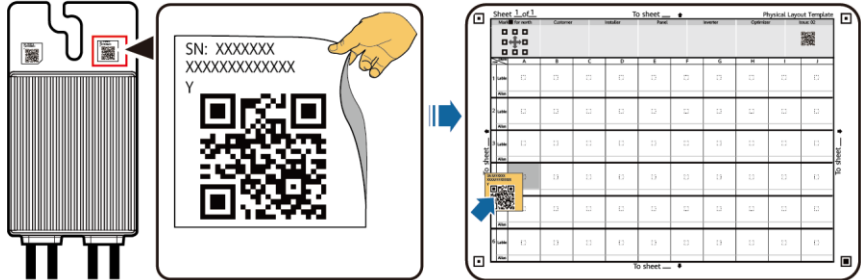

2. Install the optimizer based on the selected installation mode.

### Installed on an Extruded Aluminum Profile – T-shaped Bolt

M8x20 T-shaped bolt

Extruded aluminum profile  
Flange nut

IV05H00042

#### NOTE

- The optimizer is mounted to an aluminum profile on the front or rear side with T-shaped bolt and nut.
- The T-shaped bolt and nut need to be purchased separately from Huawei. The bolt dimensions are as follows.

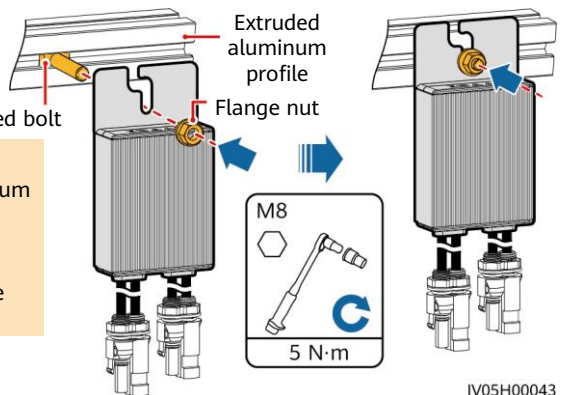
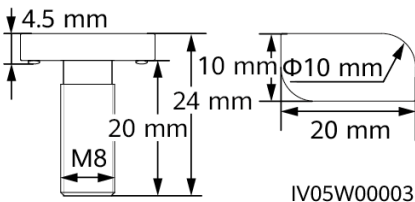

### Installed on a PV Module Frame – Bolt Assembly

#### NOTE

- Before installation, ensure that a mounting hole has been reserved on the PV module frame.
- The bolt assembly and nut need to be purchased from a third party. Ensure that the length meets the installation requirements of the PV module frame.

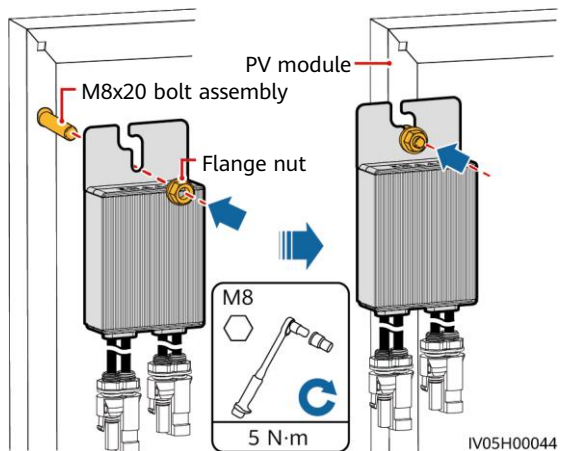

## Installed on a PV Module Frame – Frame Mounting Bracket (Front-mounted)

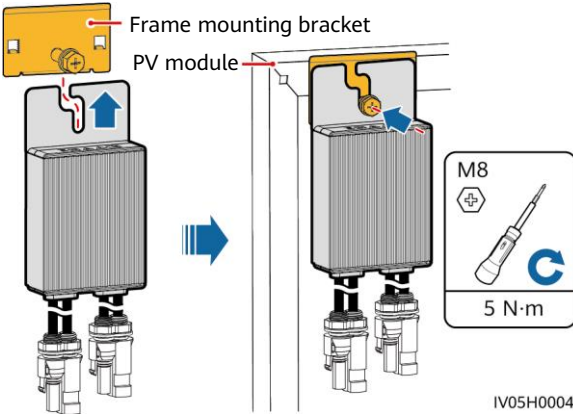

### NOTICE

- Do not press the optimizer mounting ear against the positioning pole of the frame mounting bracket.
- Purchase the frame mounting bracket separately from Huawei.
- Install the PV module after the optimizer is installed.

IV05H00045

## 3 Installing the Optimizer Cables

### NOTICE

Ensure that the input (IN) and output (OUT) cables of the optimizer are correctly connected. If they are reversely connected, the device may be damaged.

1. Connect the optimizer input (IN) cable to the PV module connection box.
2. Connect the positive probe of the multimeter to the positive output terminal of the optimizer and the negative probe to the negative output terminal. Check the output voltage and resistance of a single optimizer.

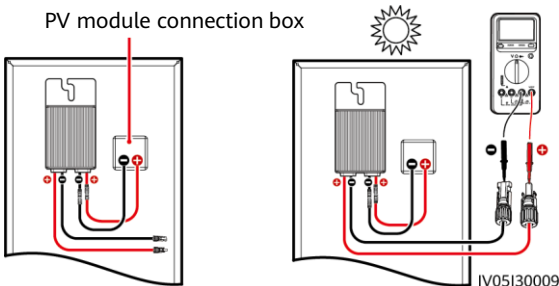

IV05I30009

- The voltage V1 is 0 V.
- The resistance R1 is 1 k $\Omega$  ( $\pm 10\%$ ). If the probes are reversely connected, the measured resistance is less than the resistance measured when the probes are correctly connected, which might be less than 0.9 k $\Omega$ .

Resistance	Cause	Suggestions
$0.9 \text{ k}\Omega \leq R1 \leq 1.1 \text{ k}\Omega$	The optimizer is normal.	N/A
$R1 < 0.9 \text{ k}\Omega$	If the probes of the multimeter are correctly connected, the optimizer is faulty.	Replace the optimizer.
$1.1 \text{ k}\Omega < R1$	<ul style="list-style-type: none"> <li>• The sunlight is weak.</li> <li>• The optimizer input is not connected.</li> <li>• The optimizer output is connected to the PV module output.</li> <li>• The optimizer is faulty.</li> </ul>	<ol style="list-style-type: none"> <li>1. Measure the resistance when the sunlight is sufficient.</li> <li>2. Connect the optimizer input power cables.</li> <li>3. Correct the optimizer cable connection. Connect the optimizer input power cables to the output cables of the PV module.</li> <li>4. If the resistance is still abnormal, replace the optimizer.</li> </ol>

**NOTE**

The measurement precision of the PV string output resistance depends on the resistance setting of the multimeter. Select the lowest resistance setting that can meet the measurement requirements.

**Common Exception Scenarios**

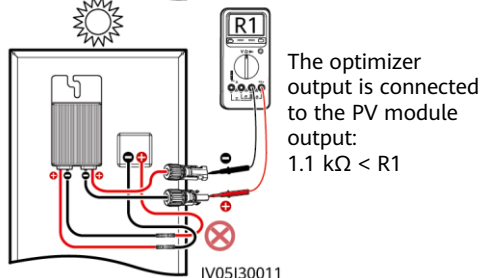
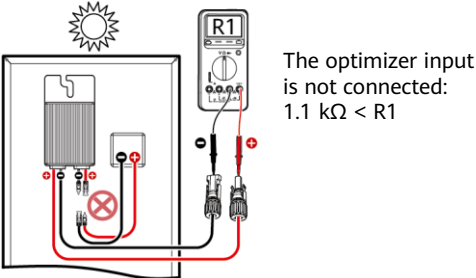
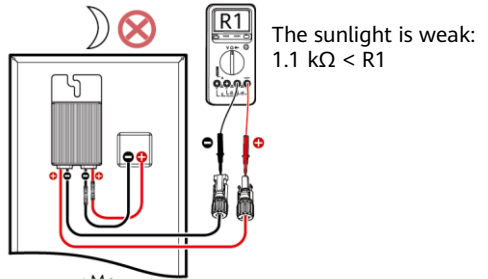
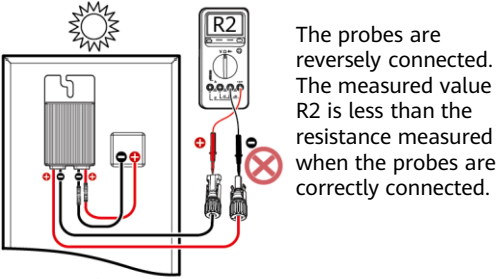

IV05I30011

3. Check that the optimizer input is properly connected, and connect the output power cables to the optimizer. Measure the PV string resistance when the sunlight is sufficient.

**Full Configuration of Optimizers**

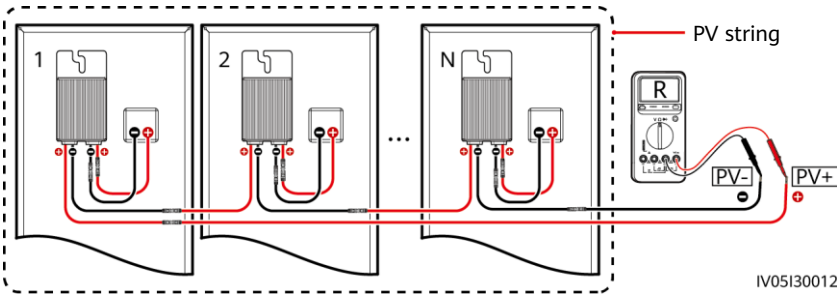

IV05I30012

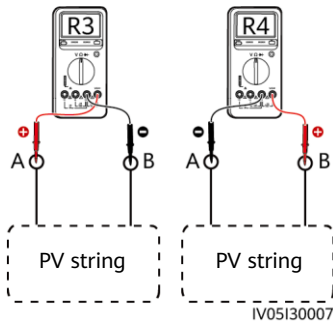

IV05130007

- a. If R is infinite, an open circuit occurs in the PV string or the cables are connected to different PV strings. Rectify the PV string open-circuit fault and correctly group the PV string cables.
- b. If R4 is less than R3, A is the positive cable of the PV string, and B is the negative cable of the PV string. If R3 is less than R4, B is the positive cable of the PV string, and A is the negative cable of the PV string. Attach correct cable labels.
- c. The resistance of each pair of PV module and optimizer is 1 kΩ. The total resistance of a PV string is 1 kΩ times the number of optimizers. If the total resistance is 10 kΩ, the number of optimizers in the PV string is 10.  
Note: The total resistance of a PV string is  $(R3 + R4)/2$ .

4. Connect cables between the PV string and the solar inverter.

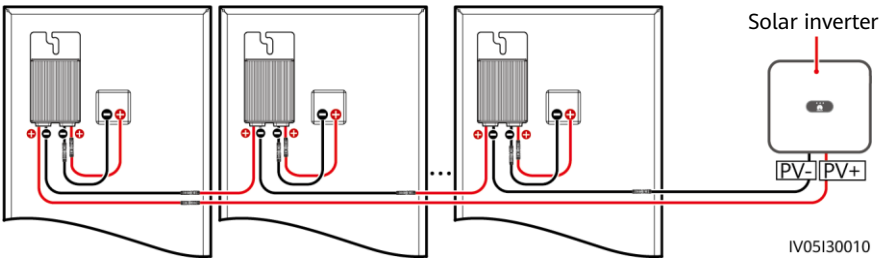

IV05130010

## 4 Power-On Commissioning

1. The physical layout of the optimizers must be provided so that you can easily locate faulty optimizers based on the physical layout diagram.
2. The physical layout of the optimizers must be provided to use the optimizer disconnection detection function. After optimizer disconnection detection is performed, the locating result can be viewed on the **Optimizer layout** page.
3. Choose **Maintenance > Subdevice management > Auto search** to add an optimizer. Create a physical layout on the **Physical layout design** screen. For details, see the corresponding solar inverter quick guide or *FusionSolar App Quick Guide*. The solar inverter quick guide is delivered with the solar inverter. You can scan the QR code to obtain *FusionSolar App Quick Guide*.

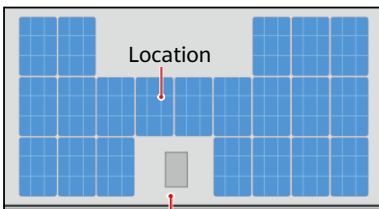

Disconnection icon    Fault icon

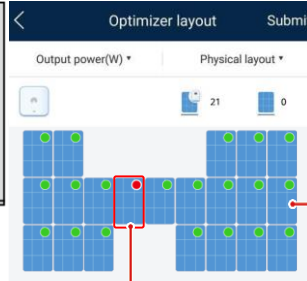

Faulty optimizer

Physical layout

IV05130013



## NOTICE

If the system has change requirements, such as adding, deleting, and replacing an optimizer, adjusting the physical position of an optimizer, or adjusting the PV string connected to the solar inverter input, power off the inverter and wait for 5 minutes before performing the change operation to avoid human injuries. After the change is performed, the optimizer search process must be performed again and the physical layout diagram must be updated. Otherwise, the networking is incomplete, optimizer faults cannot be located, or the system fails.

## 5 Troubleshooting

1. Open the FusionSolar app, log in to intl.fusionsolar.huawei.com using the installer account, choose **Me > Device Commissioning**, and connect to the WLAN hotspot of the solar inverter.
2. Select **installer** and enter the login password. Click **Log In**. The device commissioning screen is displayed.
3. Choose **Device Monitoring**, select the PV string and check the optimizer status.

Status	Description
Green	The optimizer is running properly.
Gray	The optimizer is offline. Check that the SN and location information are correct and search for the device again.
Red	The optimizer is faulty.

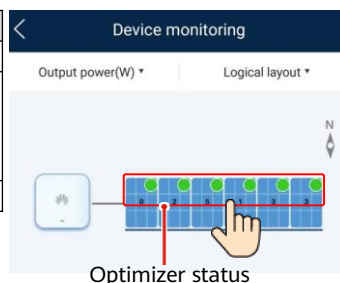

Optimizer status

Fault Alarm	Cause	Suggestions
Input overvoltage	Optimizer input overvoltage occurred.	Check whether the open-circuit voltage of the PV module connected to the optimizer exceeds 80 V.
Overtemperature protection	The optimizer internal temperature is too high.	<ol style="list-style-type: none"> <li>1. Check the ventilation and ambient temperature at the optimizer installation position. If the ventilation is poor or the ambient temperature exceeds the upper threshold, improve the ventilation and heat dissipation.</li> <li>2. If the ventilation and ambient temperature are normal, contact your dealer or Huawei technical support.</li> </ol>
Internal hardware fault	An internal fault occurred in the optimizer.	Contact your dealer or Huawei technical support.
Output backfeed	Optimizer output backfeed occurred.	<ol style="list-style-type: none"> <li>1. Check whether PV modules are severely blocked when PV strings are connected in parallel.</li> <li>2. If the fault persists, contact your dealer or Huawei technical support.</li> </ol>
Abnormal output voltage	The optimizer output voltage is abnormal.	<ol style="list-style-type: none"> <li>1. When the sunlight is normal, perform the optimizer search function again.</li> <li>2. Check whether the optimizer output extension cable is correct (positive connector at one end and negative connector at the other).</li> <li>3. Check whether the PV string is correctly connected to the inverter or whether there is a breakpoint in the PV string.</li> <li>4. If the fault persists, contact your dealer or Huawei technical support.</li> </ol>



Fault Alarm	Cause	Suggestions
Upgrade failed	The optimizer software upgrade failed.	<ol style="list-style-type: none"> <li>1. When the sunlight is normal, perform the optimizer upgrade again.</li> <li>2. If the fault persists, contact your dealer or Huawei technical support.</li> </ol>

## 6 Replacing an Optimizer

1. Power off the solar inverter and remove the faulty optimizer.
2. Install a new optimizer and correctly connect its cables.
3. Power on the solar inverter. On the Device Commissioning screen, choose **Maintenance > Subdevice management**, and tap **Auto search** to add the new optimizer.
4. On the Device Commissioning screen, choose **Maintenance > Optimizer layout**, select the corresponding PV module, and bind the new optimizer. Click **Submit**.

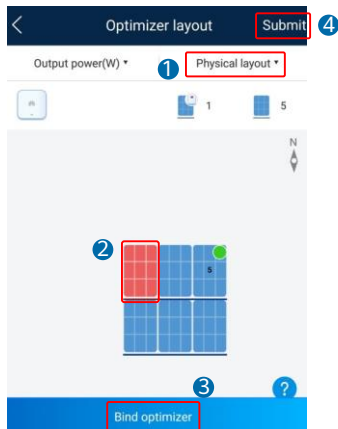
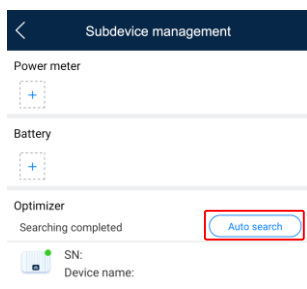

## 7 Precautions

### ⚠ WARNING

- The optimizer uses Staubli MC4 DC connectors. Ensure that the DC connectors to be connected are of this model. If the DC connectors to be connected are not of the Staubli MC4 model, the connector compatibility report and third-party lab (TUV, VED, or Bureau Veritas) report from the DC connector manufacturer must be available. Using incompatible DC connectors may result in serious consequences. The resulting device damage is beyond the warranty scope.
- The optimizer is not supported in the pure off-grid ESS networking. Otherwise, the system may fail to start.
- Partial configuration scenario: The total open-circuit voltage of the PV modules in a PV string cannot exceed the maximum input voltage of the solar inverter under any condition.

## NOTICE

- The information in this document is subject to change without notice. Every effort has been made in the preparation of this document to ensure accuracy of the contents, but all statements, information, and recommendations in this document do not constitute a warranty of any kind, express or implied.
- Only qualified and trained electrical technicians are allowed to operate the device. Operation personnel should understand the composition and working principles of the grid-tied PV power system and local regulations.
- Carefully read this document prior to installation to get familiar with product information and safety precautions. Huawei shall not be liable for any consequence caused by violation of the storage, installation, and operation regulations specified in this document and the solar inverter user manual.
- Use insulated tools when installing the device. For personal safety, wear proper personal protective equipment (PPE).
- If an optimizer does not connect to any other device, connect the OUT+ and OUT- ports of the optimizer respectively to the IN+ and IN- ports to protect the terminals from water.
- It is recommended that the positive and negative cables (PV+/PV-) between the optimizer and the solar inverter be placed side by side to avoid cable winding.
- The input end of the optimizer should be connected to the PV module connection box, and the output end to the adjacent optimizer or a solar inverter. Do not reversely connect the input and output cables. Otherwise, the optimizer may be damaged.
- The screenshots are for reference only. The actual screens may vary. Local physical layout using the solar inverter is used as an example. For details about the remote physical layout using the management system, see the *FusionSolar App Quick Guide*.

## 8 Installation Video

### NOTE

You can scan the QR codes below to obtain the installation videos.



中文



English

**Huawei Digital Power Technologies Co., Ltd.**  
Huawei Digital Power Antuoshan Headquarters, Futian  
Shenzhen 518043, People's Republic of China  
[solar.huawei.com](http://solar.huawei.com)