

ABB solar inverters

Product manual
PVS-50-TL / PVS-60-TL
(from 50 to 60kW)





IMPORTANT SAFETY INSTRUCTIONS

This manual contains important safety instructions that must be followed during the installation and maintenance of the equipment.



SAVE THESE INSTRUCTIONS!

Keep this document in a safe place near the inverter for easy access during installation, operation and maintenance.

THE INSTALLER MUST READ THIS DOCUMENT IN ITS ENTIRETY BEFORE INSTALLING THIS EQUIPMENT.

Operators are required to read this manual and scrupulously follow the instructions given in it, since ABB cannot be held responsible for damage caused to people and/or things, or the equipment, if the conditions described below are not observed.

The purpose of this document is to support the qualified technician, who has received training and/or has demonstrated skills and knowledge in construction, to install, operate and maintain the inverter. This manual covers only inverter, not any equipment (photovoltaic modules, external disconnects, etc) to which it is connected.

Warranty requirements are included in the Terms and Conditions of sale included with the inverter order.

NOTE: Any changes not approved by ABB void the warranty.

Product manual

PVS-50/60-TL string inverters

1 - Introduction and general information



2 - Characteristics



3 - Safety and accident prevention



4 - Lifting and transport



5 - Installation



6 - Instruments



7 - Operation



8 - Maintenance



9 - Attachments



Warranty and supply conditions

The warranty conditions are considered to be valid if the Customer adheres to the indications in this manual; any conditions deviating from those described herein must be expressly agreed in the purchase order.

ABB declares that the equipment complies with the provisions of law currently in force in the country of installation and has issued the corresponding declaration of conformity.

Not included in the supply

ABB accepts no liability for failure to comply with the instructions for correct installation and will not be held responsible for systems upstream or downstream of the equipment it has supplied.



It is absolutely forbidden to modify the equipment. Any modification, manipulation, or alteration not expressly agreed with the manufacturer, concerning either hardware or software, shall result in the immediate cancellation of the warranty.

The customer is fully responsible for any changes made to the system.

Given the countless array of system configurations and installation environments possible, it is essential to check the following: adequate spaces, suitable for housing the equipment; airborne noise produced based on the environment; possible flammability conditions.

ABB will NOT be held liable for defects or malfunctions arising from: improper use of the equipment; deterioration resulting from transportation or particular environmental conditions; performing maintenance incorrectly or not at all; tampering or unsafe repairs; use or installation by unqualified persons.

ABB is not responsible for any loss of the equipment, or part of it, which does not take place on the basis of the regulations and laws in force in the country of installation.

Table of Contents

Introduction and general information	4
Warranty and supply conditions	4
Not included in the supply.....	4
Table of Contents	5
Scope and target audience	9
Purpose and document structure	9
List of appendix documents	9
Operator and maintenance personnel skills/prerequisites	9
Symbols and signs	10
Characteristics	12
General conditions	12
Field of use, general conditions	13
Intended or allowed use.....	13
Limits in field of use.....	13
Improper or prohibited use	13
Identification of the equipment and manufacturer	14
Communication identification label	16
Models and range of equipment	17
List of main reference components	18
Mounting bracket	18
Inverter external view (top and rear sides)	18
Inverter external view (front, left, right and bottom sides)	19
Inverter internal view (wiring boxes)	20
Communication and control board.....	21
Principal wiring box components	22
Characteristics and technical data	23
Tightening torques	27
Cable gland clamping range	27
Overall dimensions	28
Dimensions of mounting bracket.	29
Efficiency curves	30
Power limitation (Power Derating)	31
Power reduction due to environmental conditions.....	31
Power reduction due to the input voltage	32
Power reduction due to the grid voltage	32
P- Q curve capability	33
Characteristics of a photovoltaic generator	34
Strings and arrays.....	34
Description of the equipment	35
Operating diagram	35
Mutual connection of multiple inverters	36
Notes on the system sizing.....	36





Functionality and components of the equipment	37
Highlights	37
Improved commissioning and maintenance	37
Aurora Vision® Plant Management Platform.....	37
Configurable relay	39
Remote switch-on/switch-off.....	39
Reactive power feed into the grid	39
Limiting the active power fed into the grid	39
Overvoltage surge arrester monitoring	39
Data transmission and control	39
Communication connection diagrams.....	40
Communication interface	40
Accessing to web server	40
Ethernet bus connection	41
Topographic diagram of the equipment	42
Safety devices.....	44
Anti-Islanding	44
Ground fault of the photovoltaic panels	44
String fuses	44
Overvoltage surge arresters	44
Other safeguards	44
<i>Safety and accident prevention</i>	<i>45</i>
Safety information and instructions	45
Hazardous areas and operations	46
Environmental conditions and risks	46
Signs and labels.....	46
Thermal and electrical hazard	47
Clothing and protection of personnel.....	47
Residual risks	48
Table of residual risks	48
<i>Lifting and transport.....</i>	<i>49</i>
General conditions	49
Transport and handling	49
Lifting.....	49
Unpacking and checking	49
Storage.....	50
Weight of the equipment.....	50
Types of lifting	50
List of components supplied	51
<i>Installation</i>	<i>52</i>
General conditions	52
Installation site and position.....	53
Wireless signal environmental checks.....	55
Installations above 2000 metres	56
Installations with a high level of humidity	56
Mounting of the inverter on the bracket	57



Grid output connection (AC side)	60
Characteristics and sizing of the protective earth cable	60
Installation of the second protective earthing cable	61
Residual current protection device	61
Load protection switch (AC disconnect switch)	61
Characteristics and sizing of the line cable	62
Connection to terminal block AC side	63
Operations preliminary to the connection of the PV generator	66
Checking of leakage to ground of the photovoltaic generator	66
Checking of strings voltage.....	66
Checking the correct polarity of the strings	66
Independent or parallel input channels configuration	67
Channel configuration examples	68
Independent channel configuration (default configuration)	69
Parallel channel configuration	69
Input connection to PV generator (DC side)	70
Connection of inputs on the Standard and -S models.....	71
Connection of inputs on the -SX / -SX2 models	72
Installation procedure for quick-fit connectors	73
String protection fuses (-SX / -SX2 models only)	77
Sizing of fuses	77
Communication and control board	79
Connections to the communication and control board	80
Ethernet connection	81
Serial Communication connection - Slave (RS485-1, RS485-2)	83
Serial Communication connection - Slave/Master (RS485-MAIN)	86
Remote control connection	87
Configurable Relay connection (ALARM and AUX)	87
Front cover closure	88
Instruments	89
General conditions	89
Description of the LED function	90
LED isolation fault	90
User interface	91
Measurement tolerance	91
Operation	92
General conditions	92
Commissioning	93
Commissioning via Installer for Solar Inverters mobile APP	94
Commissioning Via Web UI - Wireless connection	98
LED behaviour	106
Description of the Web User Interface	108
Access to the Web User Interface	108
Web User Interface menu structure.....	111
MAIN section.....	112
SETTING section	113
Inverter Log	117



Maintenance

USER section.....	118
NETWORK Services	119
Service TOOLS	126
INFORMATION	132
Inverter switch-off.....	133
Operator and maintenance personnel skills/prerequisites	133
Switch-off procedure	134
Maintenance.....	140
General conditions	140
Routine maintenance	141
Troubleshooting	142
Internal Webserver and wireless communication troubleshooting.....	142
Alarm Messages of the Inverter.....	144
Power limitation messages.....	156
Procedure for dismantling the Inverter	158
Registration on “Registration” website and calculation of security token (Admin Plus)	159
Replacing DC string fuses.....	162
Replacing cooling section.....	163
Replacement of the buffer battery.....	164
Verification of ground leakage	165
Behaviour of a system without leakage.....	165
Behaviour of a system with leakage.....	166
Measuring the isolation resistance of the PV generator.....	167
Storage and dismantling	168
Storage of the equipment or prolonged stop.....	168
Dismantling, decommissioning and disposal.....	168
Attachments.....	169
Port and network services used by the inverter.....	169
IP Network Services.....	169
Network Hosts.....	170
Inverter network configuration	170
Further information	171
Contact us	172

Scope and target audience

Purpose and document structure

This operating and maintenance manual is a useful guide that will enable you to work safely and carry out the operations necessary for keeping the equipment in good working order.



If the equipment is used in a manner not specified in this manual, the protection provided by the equipment may be impaired.



The language in which the document was originally written is ENGLISH; therefore, in the event of inconsistencies or doubts please ask the manufacturer for the original document.

List of appendix documents

In addition to this user manual and maintenance you can consult (and download) the product documentation by visiting www.abbsolarinverters.com.



Part of the information given in this document is taken from the original supplier documents. This document contains only the information considered necessary for the use and routine maintenance of the equipment.

Operator and maintenance personnel skills/prerequisites



Personnel in charge of using and maintaining the equipment must be skilled for the described tasks and must reliably demonstrate their capacity to correctly interpret what is described in the manual.



For safety reasons, only a qualified electrician who has received training and/or demonstrated skills and knowledge of the inverter's structure and operation may install the inverter.



The installation must be performed by qualified installers and/or licensed electricians in accordance with the existing regulations in the country of installation and in accordance of all safety rules for performing electrical works.



Inverter operation and maintenance by a person who is NOT qualified, is intoxicated, or on narcotics, is strictly forbidden.











The customer has civil liability for the qualification and mental or physical state of the personnel who interact with the equipment. They must always use the personal protective equipment (PPE) required by the laws of the country of destination and whatever is provided by their employer.

Symbols and signs

In the manual and/or in some cases on the equipment, the danger or hazard zones are indicated with signs, labels, symbols or icons.

Symbol	Description
	Indicates that it is mandatory to consult the manual or original document, which must be available for future use and must not be damaged in any way.
	General warning - Important safety information. Indicates operations or situations in which staff must be very careful.
	Dangerous Voltage - Indicates operations or situations in which staff must be very careful with regard to dangerous voltage levels.
	Hot parts - Indicates a risk arising from the presence of hot zones or zones with parts at high temperatures (risk of burns).
	Risk of explosion
	Risk of injury due to the weight of the equipment. Take care during lifting and transport
	Indicates that the area in question must not be accessed or that the operation described must not be carried out.
	Keep out of the reach of children
	Indicates that smoking and the use of naked flames is prohibited.
	Indicates that it is mandatory to carry out the described operations using the clothing and/or personal protective equipment provided by the employer.
	WEEE logo. Indicates that the product is to be disposed of according to current legislation regarding the disposal of electronic components.
	Indicates the protection rating of the equipment according to IEC 70-1 (EN 60529 June 1997) standard.
	Point of connection for grounding protection.
	Indicates the permitted temperature range

Symbol	Description
	Indicates a risk of electric shock. The discharge time of the stored energy (represented in the figure by the letters XX), is provided on the identification label.
	Direct Current
	Alternate current
	With isolation transformer
	Without isolation transformer
	Positive pole of the input voltage (DC)
	Negative pole of the input voltage (DC)
	Indicates the centre of gravity of the equipment.
	Indicates the requirement to wear acoustic protection devices in order to prevent damage to hearing



General conditions

A description of the equipment characteristics is provided to identify its main components and specify the technical terminology used in the manual.

This chapter contains information about the models, details of the equipment, characteristics and technical data, overall dimensions and equipment identification.



The customer/Installer takes full responsibility if, when reading this manual, the chronological order of its presentation provided is not observed. All information is provided considering occasional inclusion of information in previous chapters.



In certain cases, there may be a need to separately document software functionality or attach supplementary documentation to this manual which is intended for more qualified professionals.

Field of use, general conditions

ABB shall not be liable for any damages whatsoever that may result from incorrect or careless operations.



*You may not use the equipment for a use that does not conform to that provided for in the field of use. The equipment **MUST NOT** be used by inexperienced staff, or even experienced staff if carrying out operations on the equipment that fail to comply with the indications in this manual and enclosed documentation.*



Intended or allowed use

This equipment is a inverter designed for:
transforming a continuous electrical current (DC)
supplied by a photovoltaic generator (PV)
in an alternating electrical current (AC)
suitable for feeding into the public distribution grid.

Limits in field of use

The inverter can be used only with photovoltaic modules which have ground isolated input poles, unless they are accessories installed that enable earthing of the inputs. In this case you must install an insulating transformer on the AC side of the system.

Only a photovoltaic generator can be connected in the input of the inverter (do not connect batteries or other sources of power supply).

The inverter can be connected to the electricity grid only in countries for which it has been certified/approved.

The inverter cannot be connected to the DC side in parallel to other inverters to convert energy from a photovoltaic generator with a power greater than the nominal power of the single inverter.

The inverter may only be used in compliance with all its technical characteristics.

Improper or prohibited use



IT IS STRICTLY FORBIDDEN TO:

- *Install the equipment in environments subject to particular conditions of flammability or in adverse or disallowed environmental conditions, (temperature and humidity).*
- *Use the equipment with safety devices which are faulty or disabled.*
- *Use the equipment or parts of the equipment by linking it to other machines or equipment, unless expressly provided for.*
- *Modify operating parameters that are not accessible to the operator and/or parts of the equipment to vary its performance or change its isolation.*
- *Clean with corrosive products that could eat into parts of the equipment or generate electrostatic charges.*
- *Use or install the appliance or parts of it without having read and understood the contents of the user and maintenance manual.*
- *Heat or dry rags and clothing on the parts in temperature. In addition to being hazardous, doing so would compromise component ventilation and cooling.*



Identification of the equipment and manufacturer

The technical data provided in this manual does not substitute the data supplied on the labels affixed to the equipment.



The labels affixed to the equipment must NOT be removed, damaged, stained, hidden, etc., for any reason whatsoever.

PVS-50-TL:

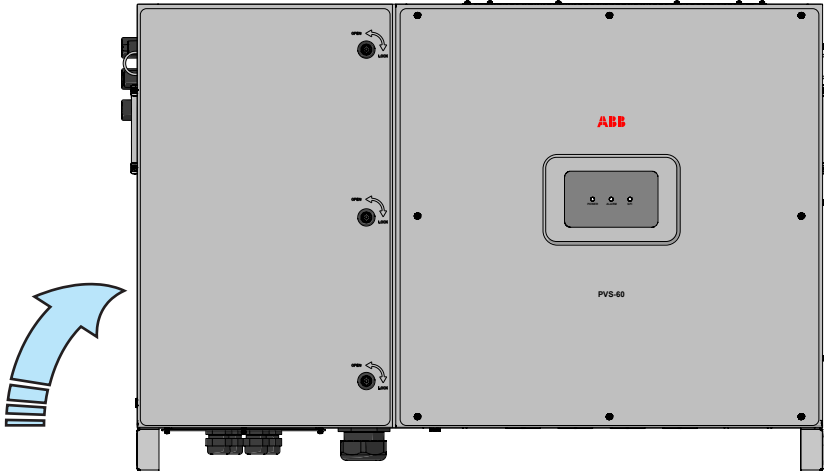

The approval label contains the following information:

1. Manufacturer
2. Model
3. Rating data
4. Certification marks

ABB 1 4 Made in Italy

www.abb.com/solar
SOLAR INVERTER

MODEL: PVS-50-TL 2

V _{dc} Operating Range	300-950 V	V _{acr}	400 V 3Ø
V _{dc} MPP	480-800 V	P _{acr} (cosφ=1)	50000 W
V _{dc} max	1000 V	P _{acr} (cosφ=0.9)	45000 W
I _{dc} max	108 A	P _{ac} max (cosφ=1)	55000 W
I _{sc} max	165 A	S _{max}	55000 VA
		f _r	50/60 Hz
		I _{ac} max	80 A

3

-25 to +60 °C
-13 to +140 °F

ABB 1 4 Made in Italy

www.abb.com/solar
SOLAR INVERTER

MODEL: PVS-50-TL 2

V _{dc} Operating Range	300-950 V	V _{acr}	400 V 3Ø
V _{dc} MPP	480-800 V	P _{acr} (cosφ=1)	50000 W
V _{dc} max	1000 V	P _{acr} (cosφ=0.9)	45000 W
I _{dc} max	108 A	P _{ac} max (cosφ=1)	55000 W
I _{sc} max	165 A	S _{max}	55000 VA
		f _r	50/60 Hz
		I _{ac} max	80 A

3

-25 to +60 °C
-13 to +140 °F

ABB 1 4 Made in Italy

www.abb.com/solar
SOLAR INVERTER

MODEL: PVS-50-TL 2

V _{dc} Operating Range	300-950 V	V _{acr}	400 V 3Ø
V _{dc} MPP	480-800 V	P _{acr} (cosφ=1)	50000 W
V _{dc} max	1000 V	P _{acr} (cosφ=0.9)	45000 W
I _{dc} max	3x36 A	P _{ac} max (cosφ=1)	55000 W
I _{sc} max	3x55 A	S _{max}	55000 VA
		f _r	50/60 Hz
		I _{ac} max	80 A

3

-25 to +60 °C
-13 to +140 °F

ABB 1 4 Made in Italy

www.abb.com/solar
SOLAR INVERTER

MODEL: PVS-50-TL 2

V _{dc} Operating Range	300-950 V	V _{acr}	400 V 3Ø
V _{dc} MPP	480-800 V	P _{acr} (cosφ=1)	50000 W
V _{dc} max	1000 V	P _{acr} (cosφ=0.9)	45000 W
I _{dc} max	3x36 A	P _{ac} max (cosφ=1)	55000 W
I _{sc} max	3x55 A	S _{max}	55000 VA
		f _r	50/60 Hz
		I _{ac} max	80 A

3

-25 to +60 °C
-13 to +140 °F



The labels are NOT to be hidden by foreign objects and parts (rags, boxes, equipment, etc.); they must be regularly cleaned and always kept in sight.

PVS-60-TL:

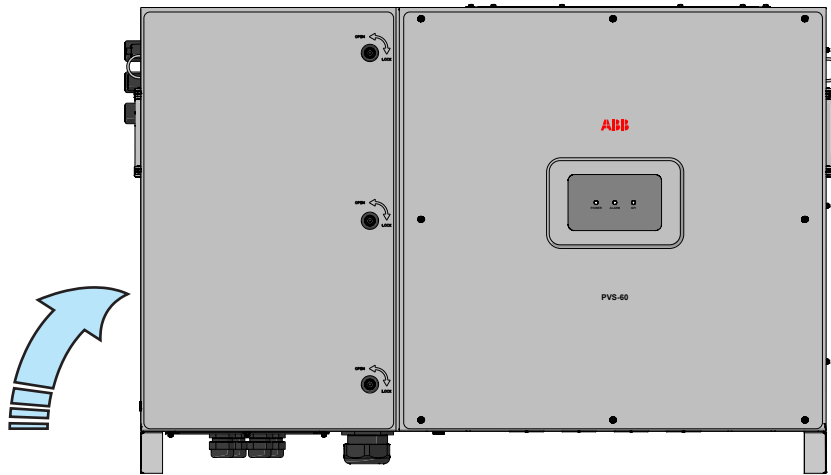

The approval label contains the following information:

1. Manufacturer
2. Model
3. Rating data
4. Certification marks



ABB 1 4 Made in Italy

www.abb.com/solar
SOLAR INVERTER

MODEL: PVS-60-TL 2

V _{dc} Operating Range	360-950 V	V _{acr}	480 V 3Ø
V _{dc} MPP	570-800 V	P _{acr} (cosφ=1)	60000 W
V _{dc} max	1000 V	P _{acr} (cosφ=±0.9)	54000 W
I _{dc} max	108 A	P _{ac} max (cosφ=1)	66000 W
I _{sc} max	165 A	S _{max}	66000 VA
		f _r	50/60 Hz
		I _{ac} max	80 A

3 IP54 Cooling Section

-25 to +60 °C
-13 to +140 °F

ABB 1 4 Made in Italy

www.abb.com/solar
SOLAR INVERTER

MODEL: PVS-60-TL 2

V _{dc} Operating Range	360-950 V	V _{acr}	480 V 3Ø
V _{dc} MPP	570-800 V	P _{acr} (cosφ=1)	60000 W
V _{dc} max	1000 V	P _{acr} (cosφ=±0.9)	54000 W
I _{dc} max	108 A	P _{ac} max (cosφ=1)	66000 W
I _{sc} max	165 A	S _{max}	66000 VA
		f _r	50/60 Hz
		I _{ac} max	80 A

3 IP54 Cooling Section

-25 to +60 °C
-13 to +140 °F

ABB 1 4 Made in Italy

www.abb.com/solar
SOLAR INVERTER

MODEL: PVS-60-TL 2

V _{dc} Operating Range	360-950 V	V _{acr}	480 V 3Ø
V _{dc} MPP	570-800 V	P _{acr} (cosφ=1)	60000 W
V _{dc} max	1000 V	P _{acr} (cosφ=±0.9)	54000 W
I _{dc} max	3x36 A	P _{ac} max (cosφ=1)	66000 W
I _{sc} max	3x55 A	S _{max}	66000 VA
		f _r	50/60 Hz
		I _{ac} max	80 A

3 IP54 Cooling Section

-25 to +60 °C
-13 to +140 °F

ABB 1 4 Made in Italy

www.abb.com/solar
SOLAR INVERTER

MODEL: PVS-60-TL 2

V _{dc} Operating Range	360-950 V	V _{acr}	480 V 3Ø
V _{dc} MPP	570-800 V	P _{acr} (cosφ=1)	60000 W
V _{dc} max	1000 V	P _{acr} (cosφ=±0.9)	54000 W
I _{dc} max	3x36 A	P _{ac} max (cosφ=1)	66000 W
I _{sc} max	3x55 A	S _{max}	66000 VA
		f _r	50/60 Hz
		I _{ac} max	80 A

3 IP54 Cooling Section

-25 to +60 °C
-13 to +140 °F

ABB 1 4 中國製造

www.abb.com/solar
太阳能并网逆变器

MODEL: PVS-60-TL 2 CN

MPP电压范围	360 - 950 V	额定输出电压	480 V 3Ø
满载MPP电压范围	570 - 800 V	额定输出功率(cosφ=1)	60000 W
最大输入电压	1000 V	输出功率(cosφ=±0.9)	54000 W
最大输入电流	3x36 A	最大输出功率(cosφ=1)	66000 W
最大短路电流	3x55 A	最大输出视在功率	66000 VA
		额定输出频率	50 / 60 Hz
		最大输出电流	80 A

3 IP54 Cooling Section

-25 to +60 °C
-13 to +140 °F



The labels are NOT to be hidden by foreign objects and parts (rags, boxes, equipment, etc.); they must be regularly cleaned and always kept in sight.

In addition to the label showing the inverter data, there is an additional identification label for the inverter.
The label displays the following information:

The diagram shows an identification label with the following fields and callouts:

- MODEL NAME** (callout to the top text)
- Inverter model** (callout to the top text)
- Inverter Part Number** (callout to P/N: P/P/P/P/P/P/P/P)
- Inverter Serial Number** consisting of:
 - YY = Year of manufacture
 - WW = Week of manufacture
 - SSSSSS = sequential number
- Week/Year of manufacture** (callout to SN: YYWWSSSSSS WK: WWYY)
- Manufacturer** (callout to POWER-ONE ITALY S.p.A. Via S. Giorgio 642, Terranuova Tavarnuzze (AR), 52028, Italia)



The officially required information is located on the approval label. The identification label is an accessory label which shows the information necessary for the identification and characterisation of the inverter by ABB.



The labels are NOT to be hidden by foreign objects and parts (rags, boxes, equipment, etc.); they must be regularly cleaned and always kept in sight.

Communication identification label

An additional Communication Identification label is applied on the wiring box. The label displays the following information:

The diagram shows a communication identification label divided into two parts by a dashed line. The top part contains:

- SN WLAN: SSSSSSSSSS** (callout to WLAN board Serial Number)
- PN WLAN: PPP.PPPPP.PP** (callout to WLAN board Part Number)
- Mac Address: XX:XX:XX:XX:XX:XX** (callout to MAC address)

The bottom part contains:

- SN WLAN: SSSSSSSSSS** (callout to WLAN board Serial Number)
- SN Inverter: SSSSSSSSSS** (callout to Inverter Serial Number)
- MAC: XX:XX:XX:XX:XX:XX** (callout to MAC address)
- PK: KKKK-KKKK-KKKK-KKKK** (callout to Product Key)

Text on the label: "Remove and apply on the Quick installation guide".

Additional information for MAC address:

- To be used to obtain the SSID of the wireless access point created by the inverter: **ABB-XX-XX-XX-XX-XX-XX** (where "X" is a hex digit of the MAC address).
- To be used to obtain the "Host Name": **http://ABB-XX-XX-XX-XX-XX-XX.local** (where "X" is a hex digit of the MAC address).
- MAC address it's the only required information to register the inverter with Aurora Vision.

Additional information for Product Key:

- To be used as wireless access point password, or to be used to access to the Web UI as username and password in case of lost credentials, and to commission inverter using ABB Installer for Solar Inverters.



The Communication Identification label is divided in two separate parts by a dashed line; take the bottom part and apply it on the plant documentation. (it's recommend to create a plant map and apply the Communication Identification label of each inverters in the right position of that map).

Models and range of equipment



The choice of the inverter model must be made by a qualified technician who knows about the installation conditions, the devices that will be installed outside the inverter and possible integration with an existing system.

The models of three-phase inverters covered by this manual are divided into two groups according to their maximum output power: 50kW and 60kW.

For each model, the following variants are available.



Inverter Model Number	Description
PVS-50-TL PVS-60-TL	<ul style="list-style-type: none"> • DC Terminal blocks. Single MPPT • AC Terminal blocks • SPD type II in both sides AC and DC monitored
PVS-50-TL-S PVS-60-TL-S	<ul style="list-style-type: none"> • DC Switch • DC Terminal blocks. Single MPPT • AC Terminal blocks • SPD type II in both sides AC and DC monitored
PVS-50-TL-SX PVS-60-TL-SX	<ul style="list-style-type: none"> • 15 DC input via fast connectors • 3 independent MPPT(parallel has to be possible) • Protection fuses on POSITIVE pole only (state monitoring not included) • DC Switch • SPD type II in both sides AC and DC monitored
PVS-60-TL-SX-CN	<ul style="list-style-type: none"> • 12 DC input via fast connectors • 3 independent MPPT (parallel has to be possible) • Protection fuses on POSITIVE pole only (state monitoring not included) • DC Switch • SPD type II in both sides AC and DC monitored
PVS-50-TL-SX2* PVS-60-TL-SX2*	<ul style="list-style-type: none"> • 15 DC input via fast connectors • 3 independent MPPT (parallel has to be possible) • Protection fuses on both poles (state monitoring not included) • DC Switch • SPD type II in both sides AC and DC monitored

All inverter models can be equipped with display by dedicated part number (“;DISPLAY” suffix)

*The SX2 versions can be equipped with SPD type I e II in DC side monitored by dedicated part number (“;SPD1+2” suffix)

List of main reference components

Mounting bracket

- 01 Mounting bracket
- 02 Locking brackets
- 03 Inverter/bracket anchor points

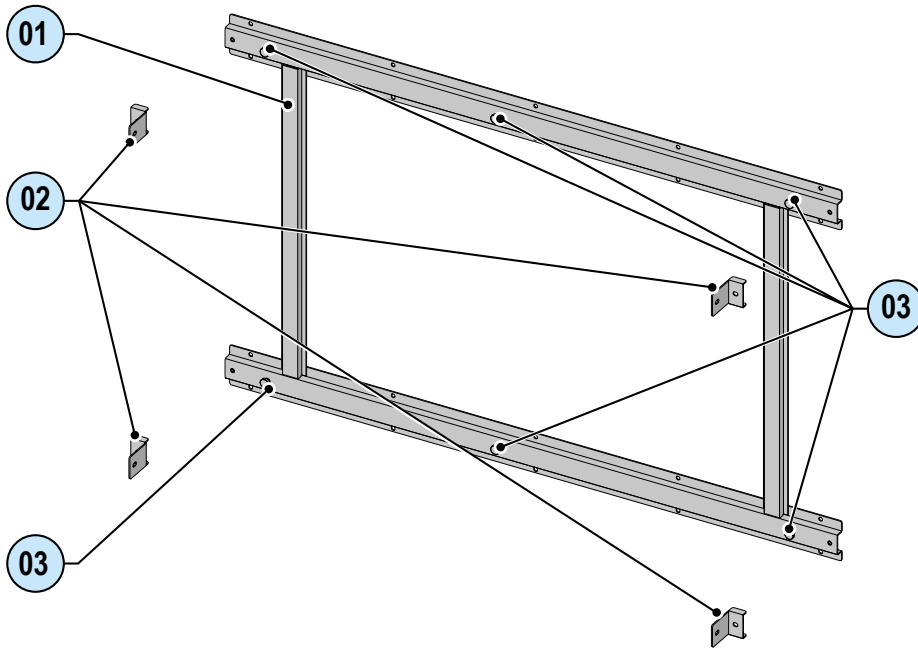

Inverter external view (top and rear sides)

- 03 Inverter/bracket anchor points

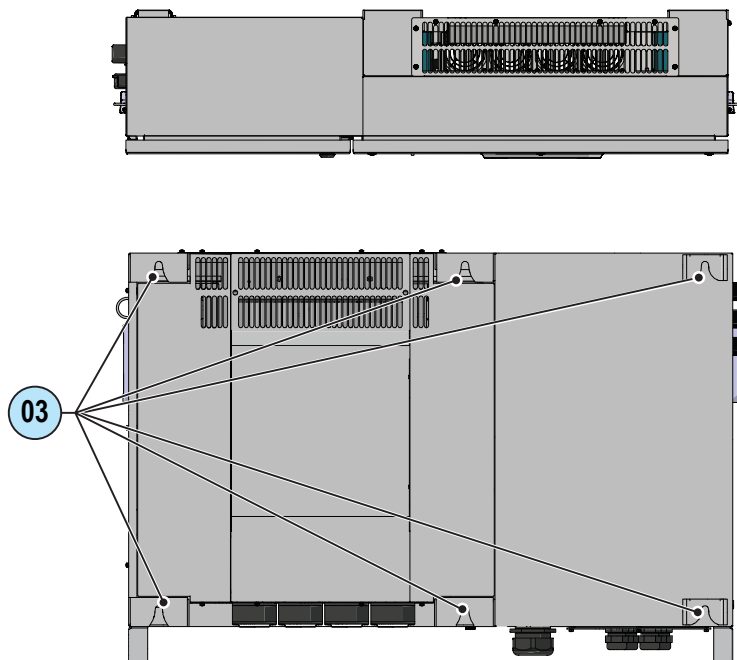

Inverter external view (front, left, right and bottom sides)

- | | | | |
|----|-----------------------------------|----|----------------------------------------|
| 04 | Wiring box front door | 15 | DC disconnect switch |
| 05 | LED panel | 16 | Protective earth terminal (external) |
| 06 | Display | 17 | DC cable glands |
| 07 | Keypad | 18 | AC cable gland |
| 08 | Key lock | 19 | Input quick fit connectors (channel 1) |
| 09 | Lifting ring | 20 | Input quick fit connectors (channel 2) |
| 10 | Wi-Fi antenna connector | 21 | Input quick fit connectors (channel 3) |
| 11 | Locking brackets attachment point | 22 | Anti-condensation valve |
| 12 | Ethernet cable gland | 23 | Cooling section |
| 13 | Service cable gland | 24 | Lower support |
| 14 | Handle | | |

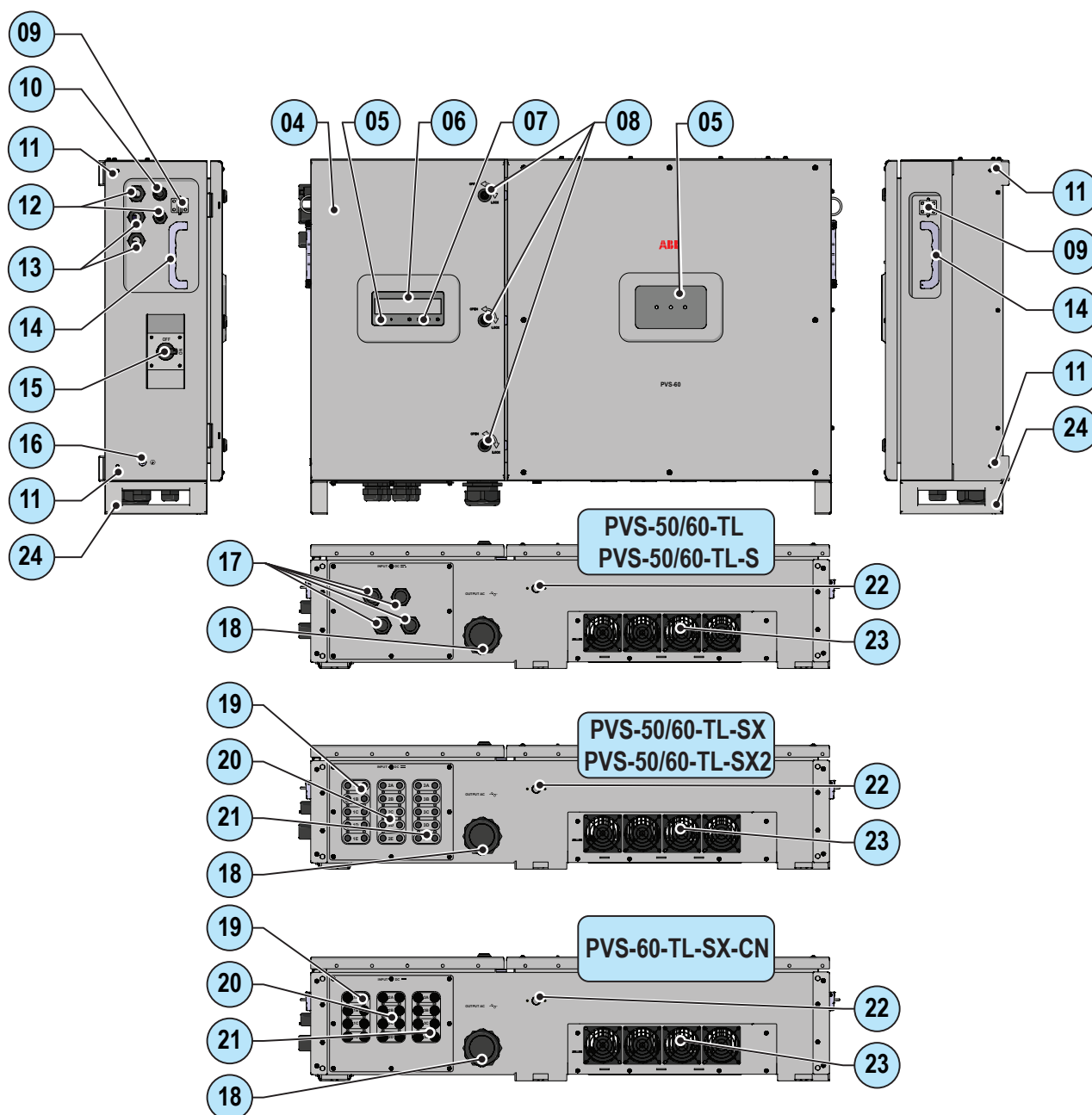

Inverter internal view (wiring boxes)

- ③① communication and control board
- ③② Grounding kit (optional kit)
- ③③ DC overvoltage surge arresters
- ③④ DC disconnect switch
- ③⑤ Negative (-) side string fuses
- ③⑥ Positive (+) side string fuses

- ④① AC overvoltage surge arresters
- ④② Protective earth terminal (internal)
- ④③ AC output screw terminal block
- ④④ DC input screw terminal block
- ④⑤ AC filter board
- ④⑥ Parallel MPPT connection points

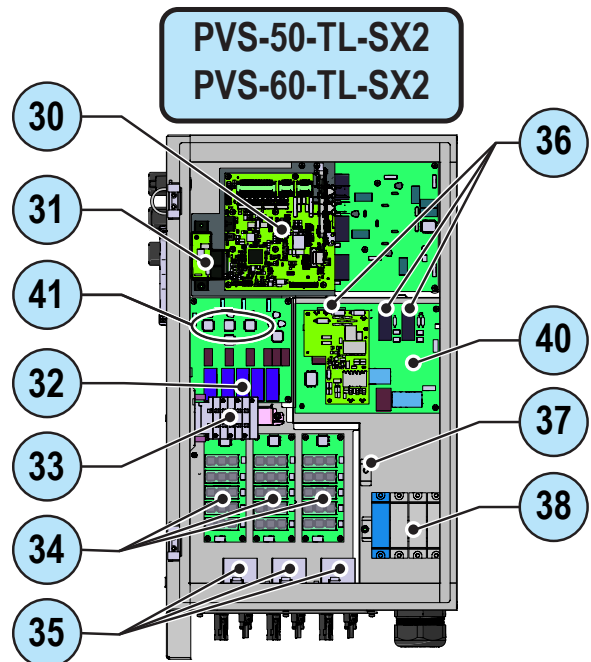
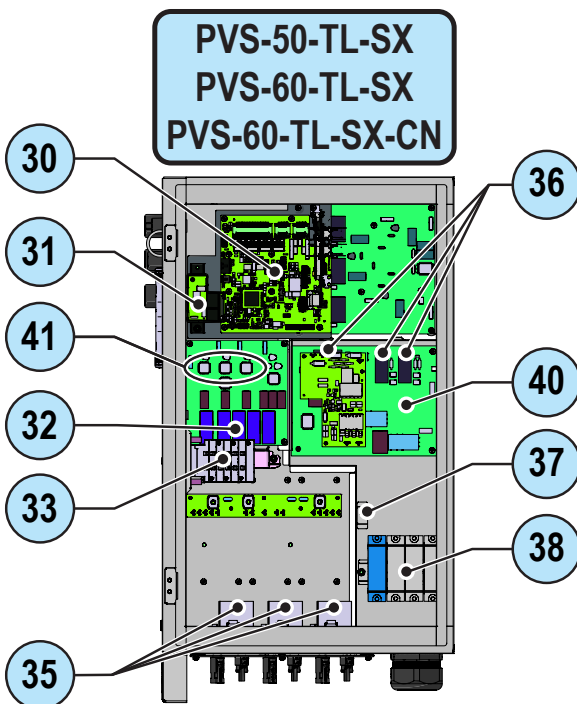
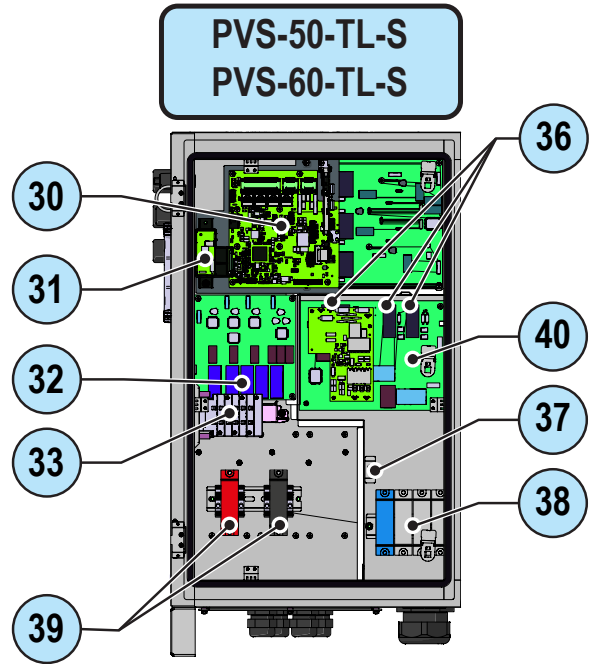
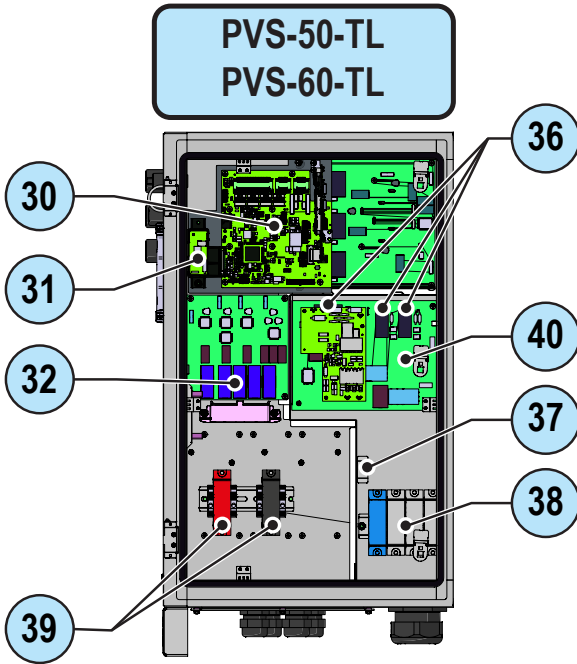

Communication and control board

- 50 Interposer board
- 51 ALARM (multifunction relay) terminal block
- 52 AUX (multifunction relay) terminal block
- 53 RS485-1 and RS485-2 lines, R1 ON/OFF and R2 ON/OFF (remote ON/OFF) and 5V auxiliary lines terminal block
- 54 RS485-1 line 120Ohm termination resistor switch
- 55 RS485-1 communication card housing
- 56 RS485-1 line connection on RJ45 connector
- 57 RS485-2 line connection on RJ45 connector
- 58 RS485-2 line 120Ohm termination resistor switch
- 59 RS485-2 communication card housing
- 60 RS485-MAIN terminal block (J5)
- 61 Battery housing
- 62 SD card housing
- 63 Grounding kit connector (optional kit)
- 64 Inverter data memory card housing
- 65 Ethernet connector

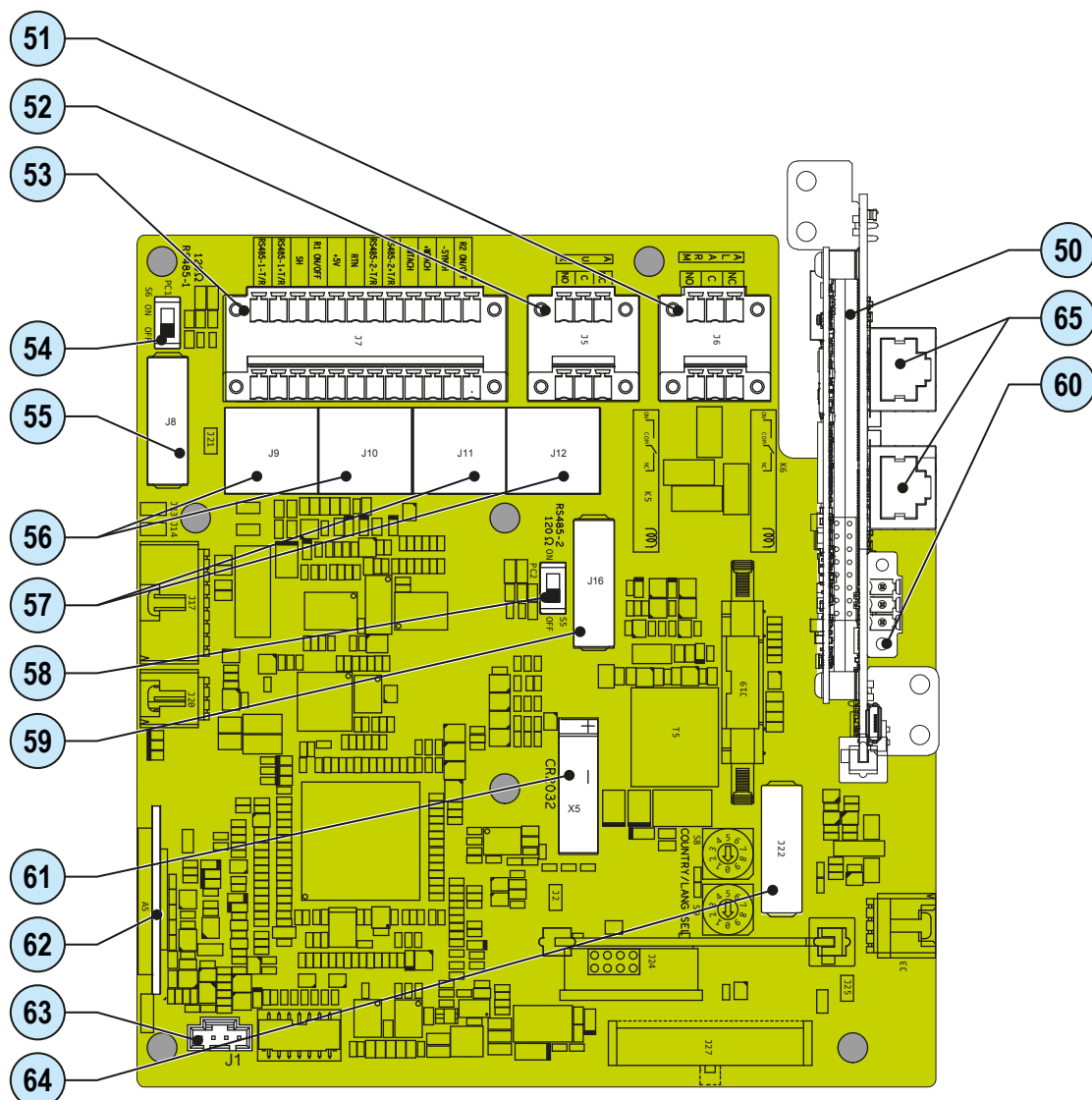

000858BG

Principal wiring box components

- DC disconnect switch ¹⁵

PVS-50/60-TL -S / -SX/ -SX2 models

Model: Nader NDG3V-50

DC disconnect switch

Voltage	Utilisation category	Current
1000Vdc	DC-21B	150A (50A for each pole)

- String fuses ³⁴ ³⁵

PVS-50/60 wiring box -SX/ -SX2

The standard string protection fuses installed on the inverter have the following features:

Voltage	Rating	Type
1000Vdc	15 A (Max. Rating 20A)	gPV

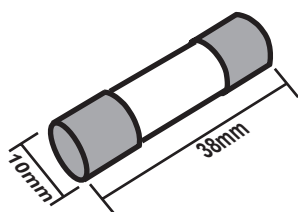

- DC overvoltage surge arresters ³²

PVS-50/60-TL all versions (Overvoltage surge arrester class 2)

The DC overvoltage surge arresters installed on these inverter models are:

Brand: PTG

Model: PV 600-40M2-M (5 elements).

These components are not replaceable.

PVS-50/60-TL-SX2;SPD 1+2 (Overvoltage surge arrester class 1+2)

The DC overvoltage surge arresters installed on this inverter model are:

Brand: PTG

Model: PTV 600-40M2-M (5 elements).

These components are not replaceable.

- AC overvoltage surge arresters ³⁶

PVS-50/60-TL all versions (Overvoltage surge arrester class 2)

The AC overvoltage surge arresters installed on these inverter models are:

Brand: PTG

Model: PTE 385-40M2-10 (4 elements)

These components are not replaceable.



In the event of damage to the surge arresters caused by atmospheric agents, spare part kits are available.

Characteristics and technical data

Table: Technical Data		PVS-50-TL
Input		
Absolute Maximum Input Voltage (V _{max,abs})	1000 V	
Input start-up voltage (V _{start})	420...700 V (default 420 V)	
DC Input operating interval (V _{dcmín} ...V _{dcmáx})	0.7xV _{start} ...950 V (min 300 V)	
Rated DC Input Voltage (V _{dcr})	610 Vdc	
DC Input Nominal Power(P _{dcr})	52000 W	
Number of Independent MPPT	3 (-SX and -SX2 version) / 1 (standard and -S version)	
Max DC Input power for each MPPT (P _{MPPT,max})	19300W@30°C/17500 W@45°C	
MPPT DC Voltage Range (V _{MPPTmin} ... V _{MPPTmax}) to P _{acr}	480-800 Vdc	
Maximum DC Input Current (I _{dcmáx}) for each MPPT	36 A	
Maximum Return current (AC side vs DC side)	Negligible in normal operating conditions ⁽³⁾	
Max short circuit current (I _{scmáx}) for each MPPT	55 A (165A in case of parallel MPPTs)	
Number of DC Connection Pairs for each MPPT	5 (-SX and -SX2 versions)	
Type of Input DC Connectors	Screw terminal block max. cross-section 95mm ² (Standard and -S version) PV quick fit connector ⁽⁴⁾ (-SX and -SX2 version)	
Type of photovoltaic panels that can be connected at input according to IEC 61730	Class A	
Input protection		
Reverse Polarity Protection	Yes, from current limited source	
Input overvoltage protection for each MPPT - SPD	Yes, 1 for each MPPT	
Input overvoltage protection for each MPPT - surge arrester	Type II/Type I+II (optional)	
Isolation Check	Complying with the local standard	
Characteristics of DC disconnect switch for each MPPT (versions with DC disconnect switch)	1000 V / 60 A for each MPPT (180 A in case of parallel MPPTs)	
String fuses (-SX/-SX2 versions)	15A (gPV / 1000Vdc) ⁽⁶⁾	
Output		
AC Connection to the grid	3W + GND (no N connection) or 4W + GND (with N connection), Grounded WYE system only	
Nominal AC Output Power (P _{acr} @cosφ=1)	50000 W	
Maximum AC Output Power (P _{acmáx} @cosφ=1)	55000 W up to 30°C	
Maximum apparent Output power (S _{máx})	55000 VA up to 30°C	
Rated AC Output Voltage (V _{acr})	400 V	
Output voltage range (V _{acmín} ...V _{acmáx})	320...480 V ⁽¹⁾	
Maximum output current (I _{acmáx})	80 A	
Contribution to short-circuit current	92 A	
Rated Output Frequency (fr)	50 Hz / 60 Hz	
Output Frequency Range (f _{mín} ...f _{máx})	47...53 Hz / 57...63 Hz ⁽²⁾	
Nominal power factor and setting interval	> 0.995, 0...1 inductive/capacitive with maximum S _{máx}	
Total harmonic distortion of current	<3%	
Max AC cable cross section accepted	95 mm ² copper copper/aluminum	
AC Connections Type	Screw terminal block - single AC cable gland M63	
Output protection		
Anti-islanding Protection	Complying with the local standard (active frequency drift combined with RoCoF techniques)	
Maximum external AC overcurrent protection	100 A	
Output overvoltage protection - SPD	Yes	



Table: Technical Data		PVS-50-TL
Output overvoltage protection - Modular surge arrester		Type II
Operating performance		
Maximum Efficiency (η_{max})		98.4%
Weighted Efficiency (EURO/CEC)		98.2% / -
Communication		
Embedded communication interface	2x RS485, 2x Ethernet (RJ45), WLAN (IEEE802.11 b/g/n @ 2,4 GHz)	
Communication protocol	Modbus RTU / TCP (SunSpec compliant); Aurora Protocol	
Remote Monitoring services	Standard level access to Aurora Vision monitoring portal	
Advanced features	Integrated Web User Interface; Display (option); Embedded logging and direct transferring of data to Cloud	
Environmental		
Ambient temperature range	-25...+60°C (-13...140°F) with derating over 45°C (113°F)	
Relative Humidity	4...100 % condensing	
Typical noise emission pressure	75 dB(A) @ 1 m	
Maximum operating altitude	4000 m (13123 ft) with derating above 2000 m / 6561 ft	
Environmental pollution degree classification for external environments	3	
Environmental class	Outdoor	
Physical		
Environmental Protection Rating	IP 65 (IP54 for the cooling section)	
Cooling System	Forced air	
Dimensions (H x W x D)	750 mm x 1100 mm x 257 mm / 29.5" x 43.3" x 10.12"	
Weight	70 kg / 154 lbs (SX version)	
Assembly System	Mounting bracket (vertical or horizontal)	
Overvoltage rating as per IEC 62109-1	II (DC input) III (AC output)	
Safety		
Safety class	I	
Isolation Level	Transformerless (TL)	
CE Marking	CE ⁽⁵⁾	
Safety and EMC Standards	IEC/EN 62109-1, IEC/EN 62109-2, EN 61000-6-2, EN 61000-6-3, EN 61000-3-11, EN 61000-3-12, CEI 0-21, CEI 0-16, DIN V VDE V 0126-1-1, VDE-AR-N 4105, G59/3, EN 50438 (not for all national appendices), RD 1699, RD 413, RD 661, P.O. 12.3, AS 4777, BDEW, NRS-097-2-1, MEA, PEA, IEC 61727, IEC 60068, IEC 61683, VFR-2014, IEC 62116	
Grid standard (check the availability with your sales channel)		
Accessories		
PVS-50/60-GROUNDING KIT	Allows to connect the negative input pole to ground	
DISPLAY	Display is available as optional by dedicated part number	

1. The output voltage range may vary according to the grid standard of the country of installation
2. The output frequency range may vary according to the grid standard of the country of installation
3. In the event of a fault, limited by the external protection envisaged on the AC circuit
4. Please refer to the document "String inverters – Product manual appendix" available at www.abb.com/solarinverters for information on the quick-fit connector brand and model used in the inverter.
5. 50Hz only
6. Maximum installable size 20A

Note. Features not specifically mentioned in this data sheet are not included in the product



Table: Technical Data		PVS-60-TL
Input		
Absolute Maximum Input Voltage (V _{max,abs})	1000 V	
Input start-up voltage (V _{start})	420...700 V (Default 500 V)	
DC Input operating interval (V _{dcmín} ...V _{dcmáx})	0,7xV _{start} ...950 V (min 360 V)	
Rated DC Input Voltage (V _{dcr})	720 V	
DC Input Nominal Power(P _{dcr})	61800 W	
Number of Independent MPPT	3 (-SX and -SX2 version) / 1 (standard and -S version)	
Max DC Input power for each MPPT (P _{MPPT,max})	23100 W@30°C/21000 W@45°C	
MPPT DC Voltage Range (V _{MPPTmin} ... V _{MPPTmax}) to P _{acr}	570...800 V	
Maximum DC Input Current (I _{dcmáx}) for each MPPT	36 A	
Maximum Return current (AC side vs DC side)	Negligible in normal operating conditions ⁽³⁾	
Max short circuit current (I _{scmáx}) for each MPPT	55 A (165A in case of parallel MPPTs)	
Number of DC Connection Pairs for each MPPT	5 (-SX and -SX2 version)	
Type of Input DC Connectors	Screw terminal block max. cross-section 95mm ² (Standard and -S version) PV quick fit connector ⁽⁴⁾ (-SX and -SX2 version)	
Type of photovoltaic panels that can be connected at input according to IEC 61730	Class A	
Input protection		
Reverse Polarity Protection	Yes, from current limited source	
Input overvoltage protection for each MPPT - SPD	Yes, 1 for each MPPT	
Input overvoltage protection for each MPPT - surge arrester	Type II / Type I+II (optional)	
Isolation Check	Complying with the local standard	
Characteristics of DC disconnect switch for each MPPT (versions with DC disconnect switch)	1000 V / 60 A for each MPPT (180 A in case of parallel MPPTs)	
String fuses (-SX/-SX2 versions)	15A (gPV / 1000Vdc) ⁽⁶⁾	
Output		
AC Connection to the grid	3W + GND (no N connection) or 4W + GND (with N connection) Grounded WYE system only	
Nominal AC Output Power (P _{acr} @cosφ=1)	60000 W	
Maximum AC Output Power (P _{acmáx} @cosφ=1)	66000 W up to 30°C	
Maximum apparent Output power (S _{máx})	66000 VA up to 30°C	
Rated AC Output Voltage (V _{acr})	480 Vac	
Output voltage range (V _{acmín} ... V _{acmín})	384...571 Vac ⁽¹⁾	
Maximum output current (I _{acmáx})	80 A	
Contribution to short-circuit current	92 A	
Rated Output Frequency (fr)	50 Hz / 60 Hz	
Output Frequency Range (f _{mín} ...f _{máx})	47...53 Hz / 57...63 Hz ⁽²⁾	
Nominal power factor and setting interval	> 0.995, 0...1 inductive/capacitive with maximum S _{máx}	
Total harmonic distortion of current	<3%	
Max AC cable cross section accepted	95 mm ² copper/aluminum	
AC Connections Type	Screw terminal block - single AC cable gland M63	
Output protection		
Anti-islanding Protection	Complying with the local standard (active frequency drift combined with RoCoF techniques)	
Maximum external AC overcurrent protection	100 A	
Output overvoltage protection - Varistors	Yes	
Output overvoltage protection - Modular surge arrester	Type 2	
Operating performance		
Maximum Efficiency (η _{máx})	98.6%	

Table: Technical Data		PVS-60-TL
Weighted Efficiency (EURO/CEC)	98.4% / -	
Communication		
Embedded communication interface	2x RS485, 2x Ethernet (RJ45), WLAN (IEEE802.11 b/g/n @ 2,4 GHz)	
Communication protocol	Modbus RTU / TCP (Sunspec compliant); Aurora Protocol	
Remote Monitoring services	Standard level access to Aurora Vision monitoring portal	
Advanced features	Integrated Web User Interface; Display (option); Embedded logging and direct transferring of data to Cloud	
Environmental		
Ambient temperature range	-25...+60°C (-13...140°F) with derating over 45°C (113°F)	
Relative Humidity	4...100 % with condensation	
Typical noise emission pressure	75 dB(A) @ 1 m	
Maximum operating altitude without derating	4000 m (13123 ft) with derating above 2000 m / 6561 ft	
Environmental pollution degree classification for external environments	3	
Environmental class	Outdoor	
Physical		
Environmental Protection Rating	IP 65 (IP54 for the cooling section)	
Cooling System	Forced air	
Dimensions (H x W x D)	750 mm x 1100 mm x 257 mm / 29.5" x 43.3" x 10.12"	
Weight	70 kg / 154 lbs (SX version)	
Assembly System	Mounting bracket (vertical or horizontal)	
Overvoltage rating as per IEC 62109-1	II (DC input) III (AC output)	
Safety		
Safety class	I	
Isolation Level	Without transformer (TL)	
CE Marking	CE ⁽⁹⁾	
Safety and EMC Standards	IEC/EN 62109-1, IEC/EN 62109-2, EN 61000-6-2, EN 61000-6-3, EN 61000-3-11, EN 61000-3-12, CEI 0-21, CEI 0-16, DIN V VDE V 0126-1-1, VDE-AR-N 4105, G59/3, EN 50438 (not for all national appendices), RD 1699, RD 413, RD 661, P.O. 12.3, AS 4777, BDEW, NRS-097-2-1, MEA, PEA, IEC 61727, IEC 60068, IEC 61683, VFR-2014, IEC 62116	
Grid standard (check the availability with your sales channel)		
Accessories		
PVS-50/60-GROUNDING KIT	Allows to connect the negative input pole to ground	
DISPLAY	Display is available as optional by dedicated part number	

1. The output voltage range may vary according to the grid standard of the country of installation
2. The output frequency range may vary according to the grid standard of the country of installation
3. In the event of a fault, limited by the external protection envisaged on the AC circuit
4. Please refer to the document "String inverters – Product manual appendix" available at www.abb.com/solarinverters for information on the quick-fit connector brand and model used in the inverter.
5. 50Hz only
6. Maximum installable size 20A

Note. Features not specifically mentioned in this data sheet are not included in the product

Tightening torques

To maintain the IP65 protection of the system and for optimal installation, the following tightening torques must be used:

Component	
DC input terminal block ⑬ 95 mm ² (Standard / -S version)	20.0 Nm
AC output terminal block 95 mm ²	20.0 Nm
Signal Terminal Block 1.5 mm ² Max	2.5 Nm
Service cable gland ③④ (PG 21)	7.5 Nm
DC cable glands ⑪ M32 (only Standard / -S versions)	8.0 Nm
AC cable gland M63	10.0 Nm
Ethernet cable gland (PG 21)	7.5 Nm
Ethernet cable gland (PG 16)	5.0 Nm
Protective earth terminal (external) ⑯	11.0 Nm
Protective earth terminal (internal) ⑳	11.0 Nm



Cable gland clamping range

Component	
Service cable gland ③④ (PG 21)	13...18mm
DC cable glands ⑪ M32 (Standard / -S versions)	13...21mm
AC cable gland M63	25...44mm
Ethernet cable gland (PG 21)	13...18mm
Ethernet cable gland (PG 16)	10...14mm

Overall dimensions

The overall dimensions are expressed in millimetres and include the mounting bracket.

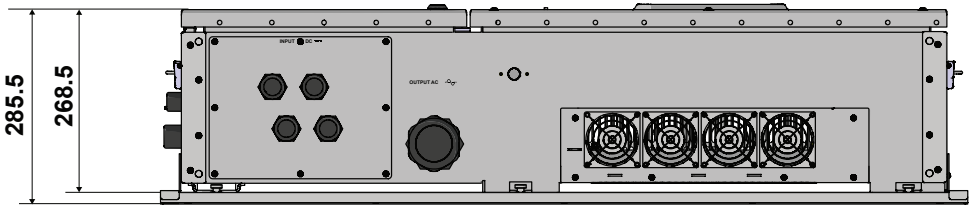
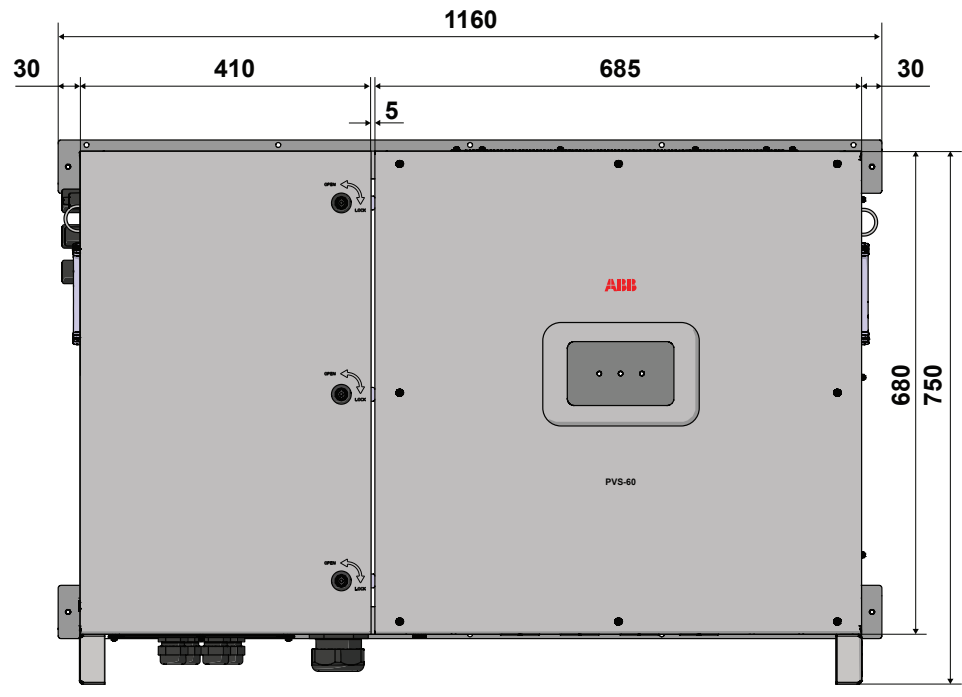
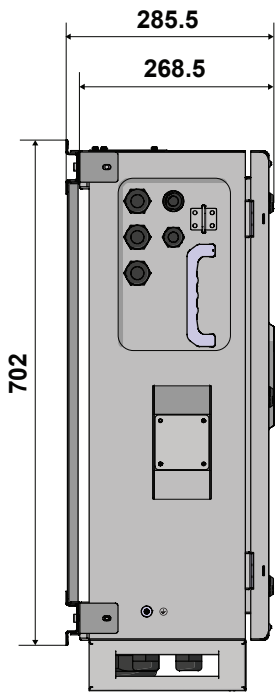
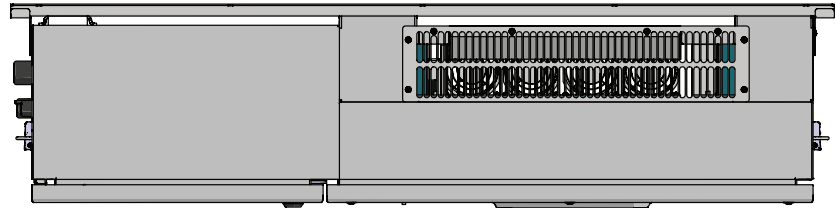

Dimensions of mouting bracket.

The dimensions of the wall mounting bracket are expressed in millimetres.

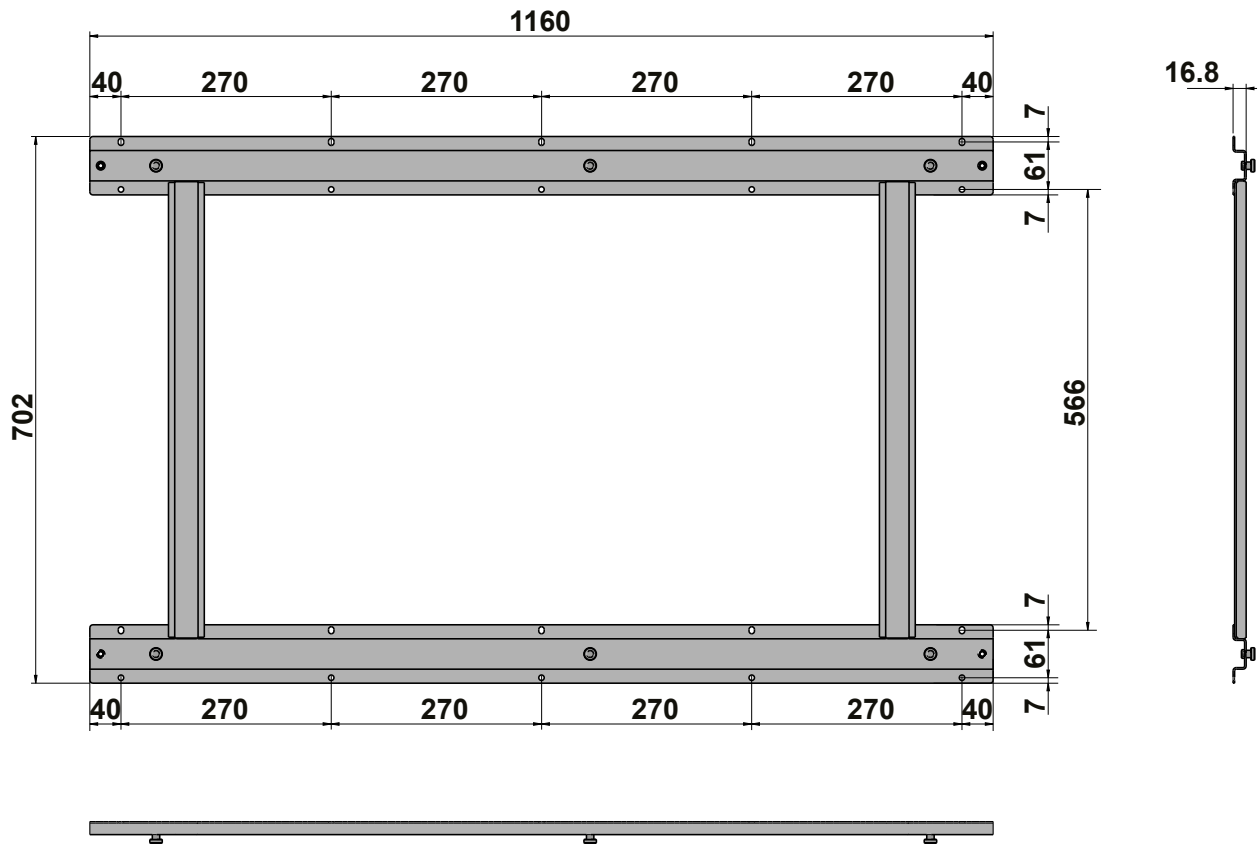

Efficiency curves

The equipment was designed considering current energy conservation standards, to avoid waste and unnecessary leakage.

Graphs of the efficiency curves of all models of inverter described in this manual are shown below.

The efficiency curves are linked to technical parameters that are continually being developed and improved and should therefore be considered approximate.



PVS-50-TL

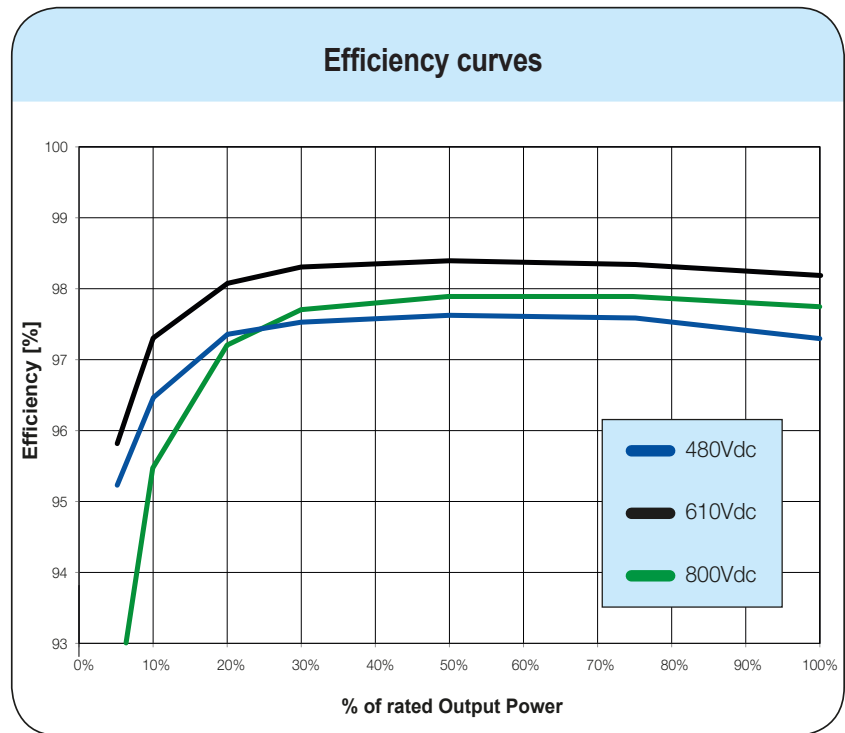

PVS-60-TL

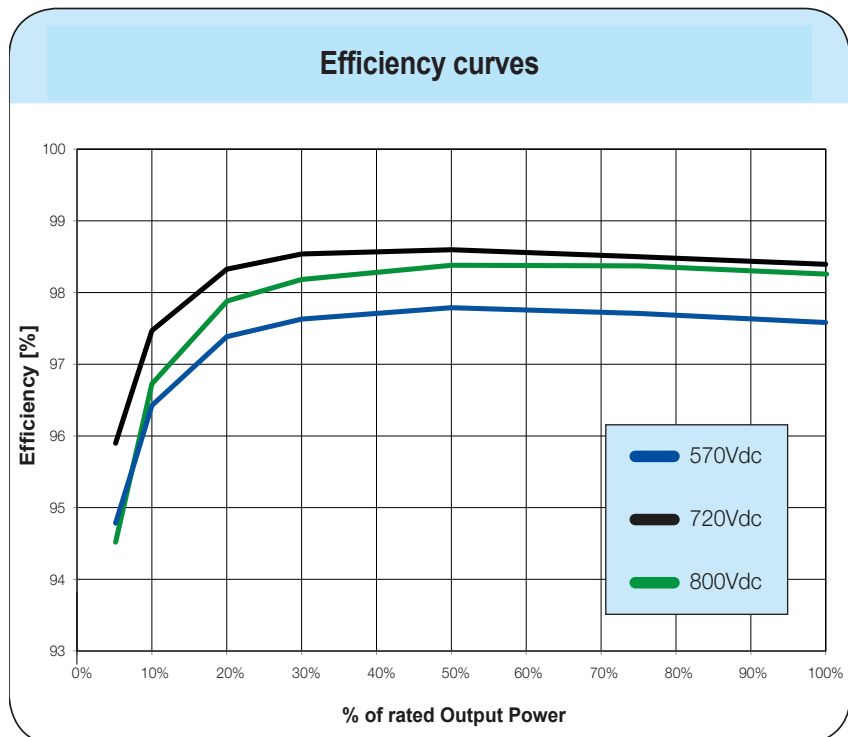

Power limitation (Power Derating)

In order to allow inverter operation in safe thermal and electrical conditions, the unit automatically reduces the value of the power fed into the grid.

Power limiting may occur due to:

- Adverse environmental conditions (thermal derating)
- Percentage of output power (value set by the user)
- Grid voltage over frequency (mode set by user)
- Grid overvoltage $U > 10\text{min Der.}$ (enabling carried out by user)
- Anti-islanding
- Grid under voltage
- Input voltage values too high.
- High input current values.



Power reduction due to environmental conditions

The power reduction value and the inverter temperature at which it occurs depend on the ambient temperature and on many operating parameters.

Example: input voltage, grid voltage and power available from the photovoltaic field.

The inverter can therefore reduce the power during certain periods of the day according to the value of these parameters.

In any case, the inverter guarantees the maximum output power even at high temperatures, provided the sun is not shining directly on it.

PVS-50-TL
PVS-60-TL

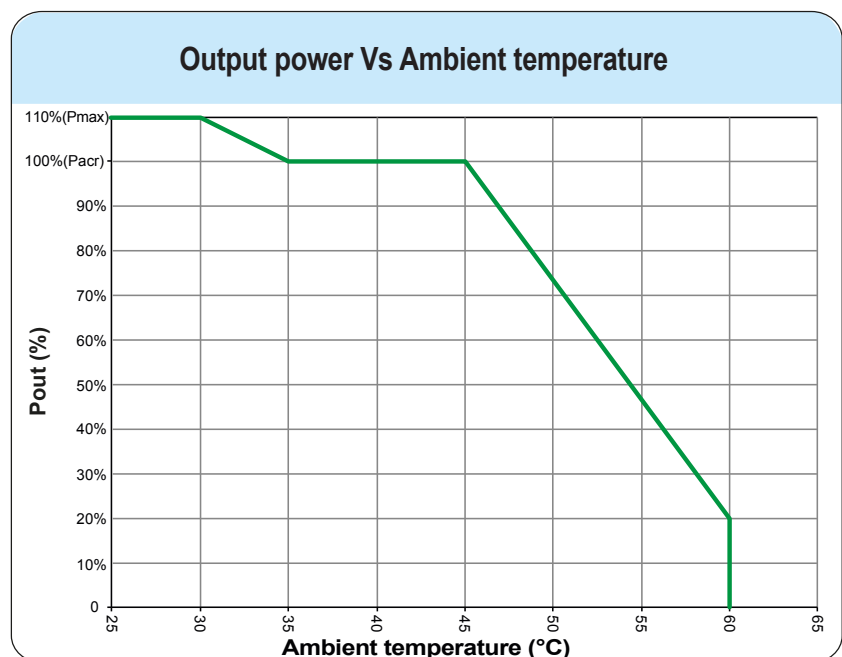

Power reduction due to the input voltage

The reduction of the power supplied where the DC input voltage values are too high or too low is adjusted automatically.

PVS-50-TL
PVS-60-TL

* The curves on the graph, indicate how "All input powered", are valid if the input voltages (of each input channel) are balanced.

* The curves on the graph are valid with nominal value of grid voltage.

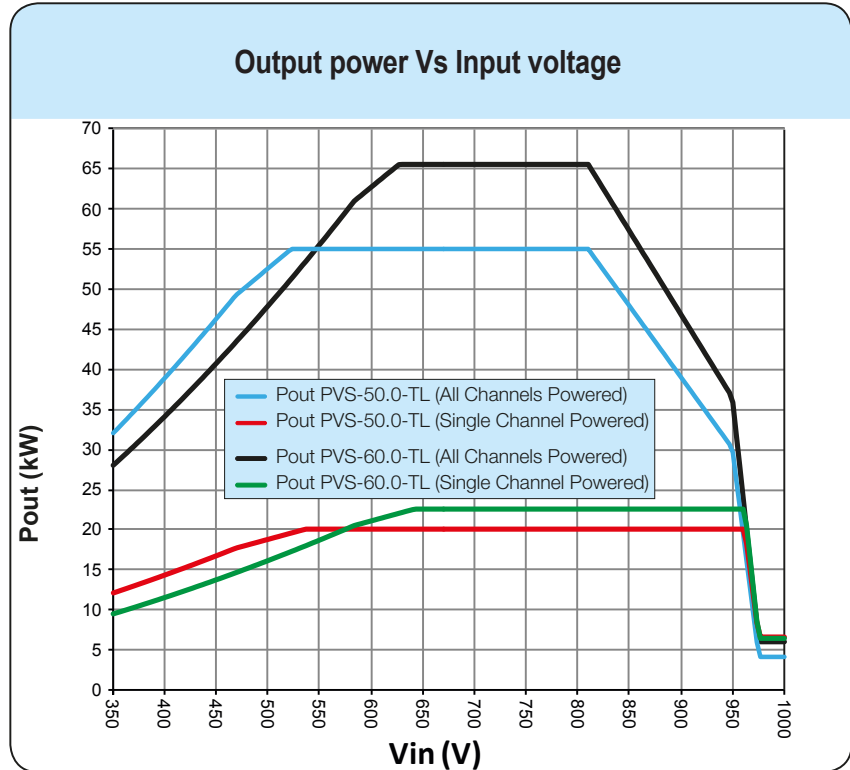

Power reduction due to the grid voltage

The reduction of the power supplied where the grid voltage values are too high or too low is adjusted automatically.

PVS-50-TL
PVS-60-TL

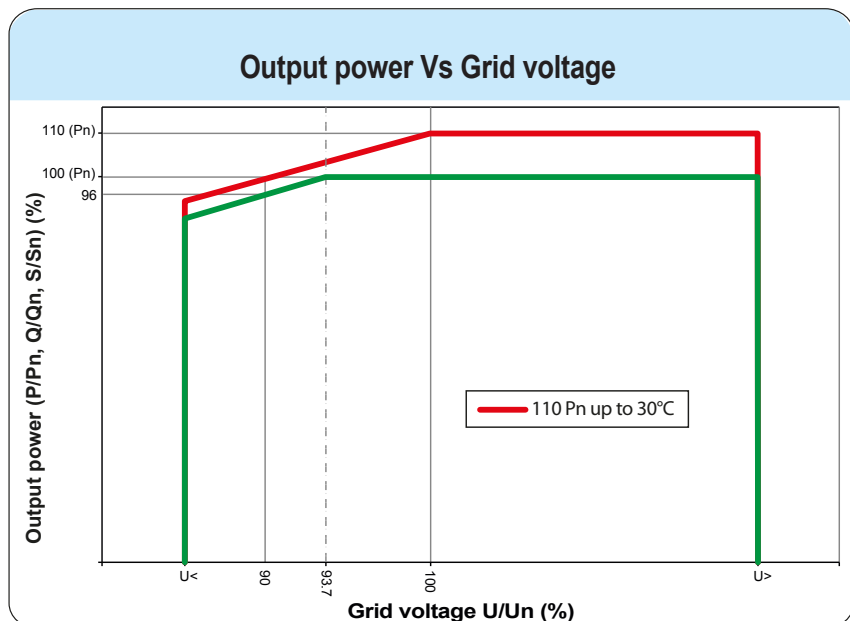

The U< and U> values could change based on the grid country standard selection

P-Q curve capability

Based on the country grid standard the P-Q capability curve can be reduced.

Conditions:

PVS-50-TL

- Rated output voltage (U_n) 400Vac
- Rated active power (P_n) 50kW (55kW up to 30°C amb. temperature)
- Nominal apparent power (S_n) 50kVA (55kVA up to 30°C amb. temperature)
- Rated reactive power (Q_n) 50kVAR
- Cos -0 ... 1 ... 0 +
- 100% P_n Capability with grid voltage between $0.937 \times U_n$... $1.2 \times U_n$
- 110% P_n Capability with grid voltage between $1.0 \times U_n$... $1.1 \times U_n$ up to 30°C amb. temperature



PVS-60-TL

- Rated output voltage (U_n) 480Vac
- Rated active power (P_n) 60kW (60kW up to 30°C amb. temperature)
- Nominal apparent power (S_n) 60kVA (60kVA up to 30°C amb. temperature)
- Rated reactive power (Q_n) 60kVAR
- Cos -0 ... 1 ... 0 +
- 100% P_n Capability with grid voltage between $0.937 \times U_n$... $1.2 \times U_n$
- 110% P_n Capability with grid voltage between $1.0 \times U_n$... $1.1 \times U_n$ up to 30°C amb. temperature

PVS-50-TL
PVS-60-TL

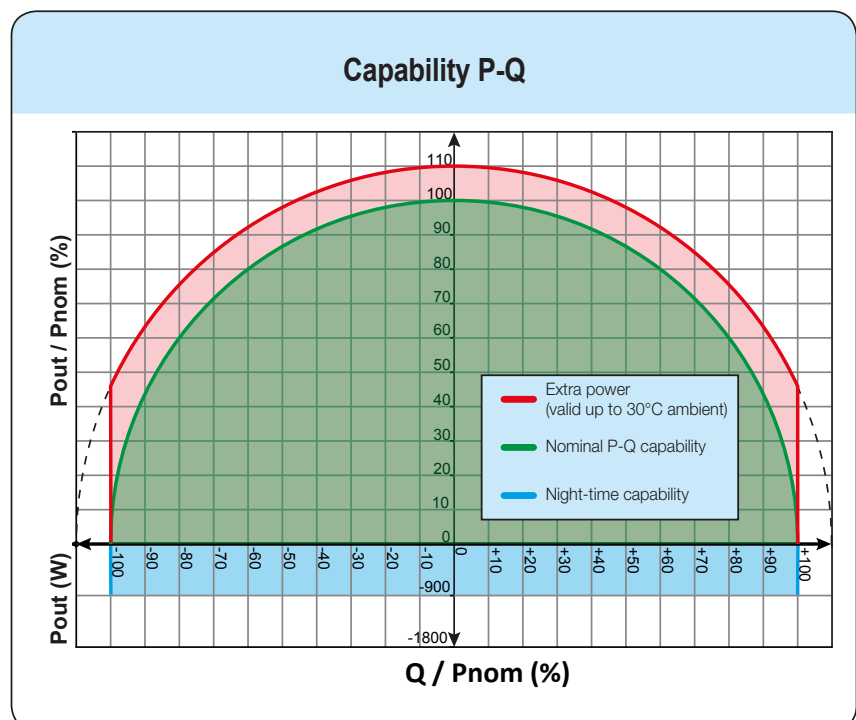

Characteristics of a photovoltaic generator

A PV generator consists of an assembly of photovoltaic modules that transform solar radiation into DC electrical energy and can be made up of:

Strings: number (X) of PV modules connected in series

Array: group of X strings connected in parallel



Strings and arrays

The string technology was developed to significantly reduce the installation costs of a photovoltaic system, mainly associated to wiring on the DC side of the inverter and subsequent distribution on the AC side. A photovoltaic panel consists of many photovoltaic cells mounted on the same support.

- A string consists of a certain number of panels connected in series.
- An array consists of two or more strings connected in parallel.

Large photovoltaic systems can include multiple arrays connected to one or more inverters.

The greater the number of panels in each string, the lower the cost and the less complex the wiring connections of the system.

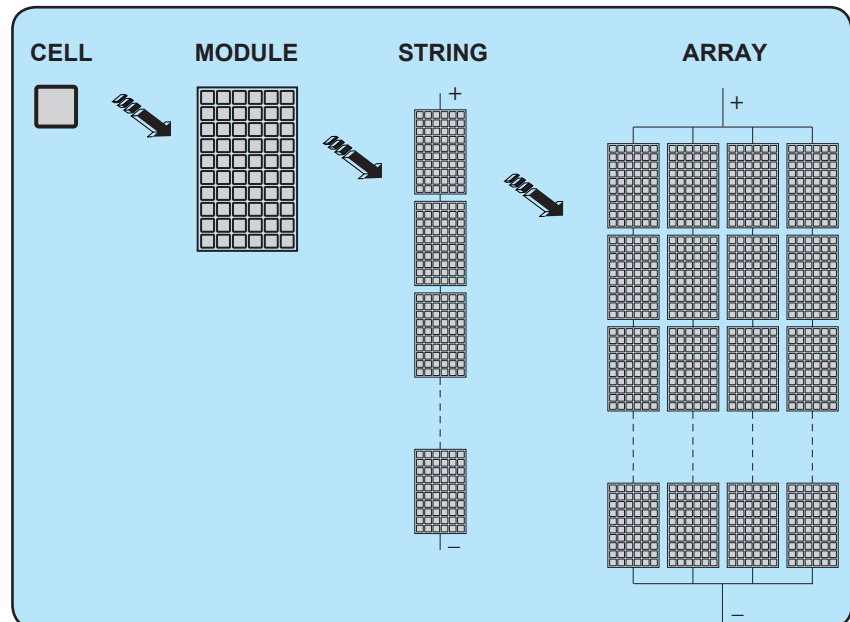

The current of each array must fall within the limits of the inverter.

Description of the equipment

This equipment is a string inverter which converts the direct current of a photovoltaic generator into alternating current and feeds it into the public distribution grid.

Photovoltaic panels convert solar radiation into “DC” electrical energy (via a photovoltaic field, also called PV generator); in order to use it, it is transformed into “AC” alternate current. This conversion, known as inversion from DC to AC, is done in an efficient way by the ABB inverters, without using any rotary elements, rather only via static electronic systems. In order to allow inverter operation in safe thermal and electrical conditions, the unit automatically reduces the value of the power fed into the grid under adverse environmental conditions or unsuitable input voltage values.

When connected in parallel with the grid, the alternating current from the inverter flows directly into the domestic or industrial distribution circuit, which is in turn connected to the public distribution grid.

This way the solar energy system compensates for the energy drawn from the utilities connected to the grid to which it is linked.

When the photovoltaic system is not generating sufficient energy, the power required to ensure proper operation of connected loads is taken from the public distribution grid. While if too much energy is produced, it is directly fed to the grid, thus becoming available to other users.

According to national and local standards and regulations the produced energy can be sold to the grid or credited to the user against future consumption, thus granting a great saving of money.



Operating diagram

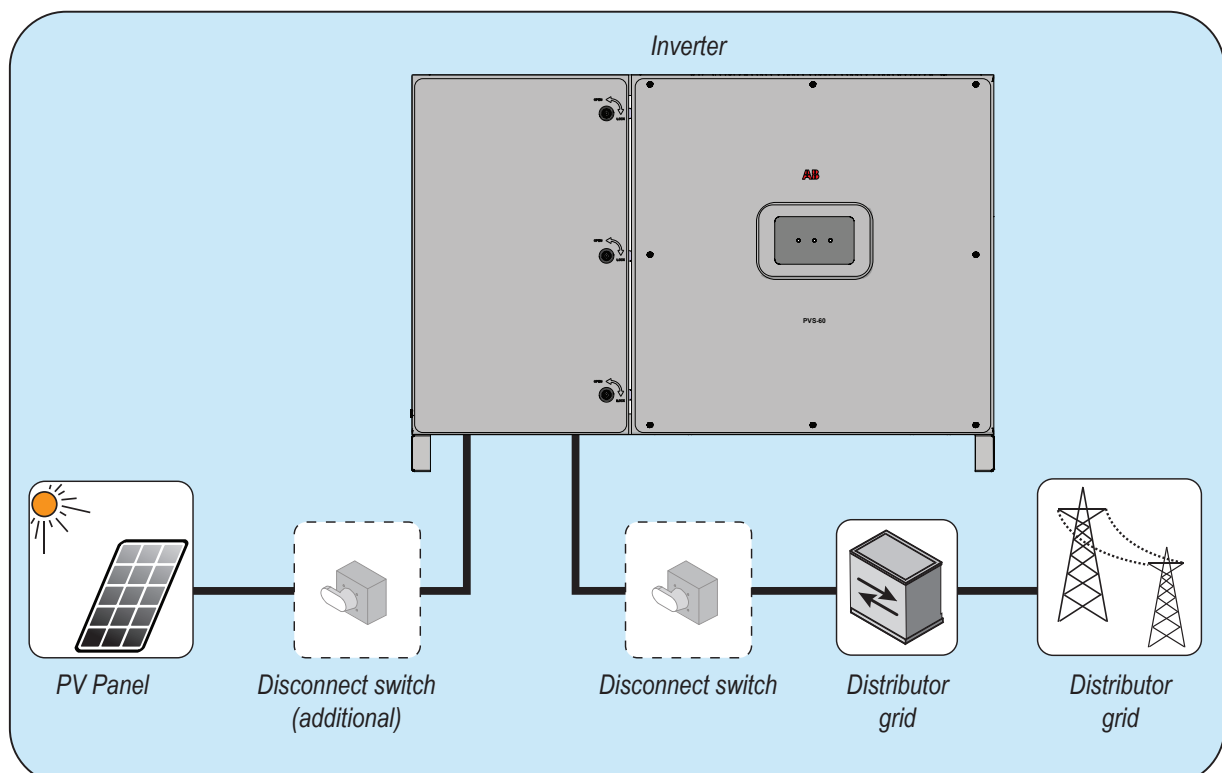

Mutual connection of multiple inverters

If the photovoltaic system exceeds the capacity of a single inverter, it is possible to connect multiple inverters to the system, each of them in turn connected on the DC side to an appropriate section of the photovoltaic generator, and on the AC side to the distribution grid.

Each string inverter will work independently of the others and its own photovoltaic module will supply the maximum power available to the grid.



Notes on the system sizing

Decisions on how to structure a photovoltaic system depend on a series of factors and considerations, such as the type of panels, the space availability, the future location of the system, energy production goals over the long term, etc.

A configuration program that can help to correctly size the photovoltaic system is available on the ABB website (<http://stringsizer.abb.com>).

Functionality and components of the equipment

Highlights

- 3 Independent MPPT (only for SX and SX2 versions)
- Transformerless inverter
- Double stage topology for a wide input range
- Large set of specific grid codes available which can be selected directly in the field
- Both vertical and horizontal installation
- 2 available sizes, 50 and 60 kW with 400 and 480 Vac of output voltage, respectively
- Wireless access to embedded user interfaces
- Ethernet daisy chain enabled
- Modbus TPC/RTU Sunspec compliant
- Remote monitoring and firmware update via Aurora Vision® (logger free)



Improved commissioning and maintenance

ABB Installer for Solar Inverters APP

Improved multi inverter installation with ABB Installer for Solar Inverters APP by using Android mobile devices (the app for iOS mobile devices will be implemented soon).

Integrated Web User Interface

The inverter is equipped with an ethernet and wireless (IEEE802.11 b/g/n) board and with an Integrated Web User Interface that allow a full access to all main configuration and parameters of the inverter. It can be accessed by using from any ethernet or wireless capable device like laptop, tablet or smartphone via a common internet browser.

Remote firmware update function

The inverter firmware can be updated remotely using the Integrated Web User Interface dedicated section or via Aurora Vision® or via ABB Installer for Solar Inverters APP.

Aurora Vision® Plant Management Platform

Integrated logging capability allows remote monitoring of the plant without the need of any additional external loggers.

Aurora Vision is a cloud based platform enabling remote monitoring and asset management of ABB devices in range of solar power application.

Aurora Vision consists of a three different product:

1. **Plant Portfolio Manager** is a full featured web based application used by solar power professionals to monitor and manage a portfolio of solar power plants using ABB inverters.

2. **Plant Viewer** is an easy to use web based serviced application used by non-solar power professionals (such as homeowners or small business owners) to monitor solar power plants they own.

3. **Plant Viewer for Mobile** is the mobile version of **Plant Viewer** enabling non-solar power professionals to remotely monitor their own PV plants by using smart phones, tablets and iPod Touch with IOS and Android operating systems.

All three product previously mentioned work together to allow solar power professional and site owners to collaboratively manage solar power plant.

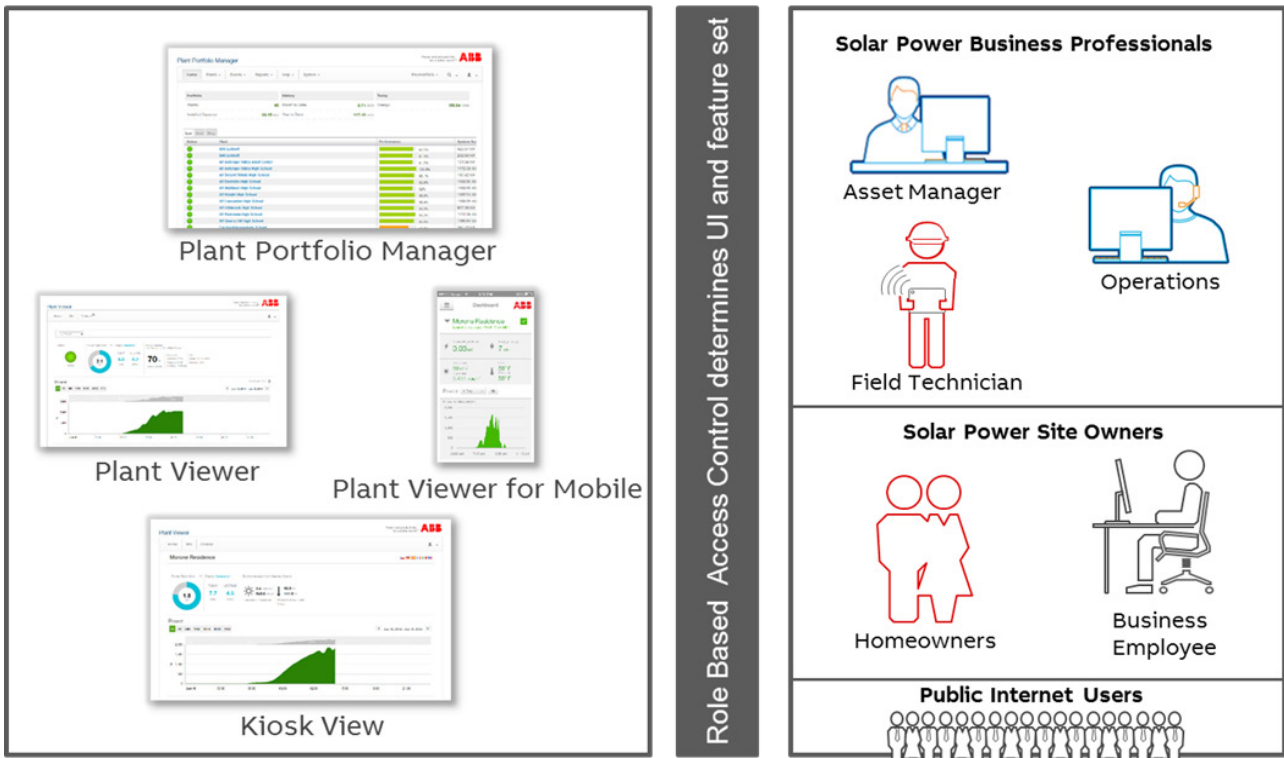

Please contact the ABB technical support for getting your own plant portfolio manager account (mainly for installers and plant administrators). Please get your Plant Viewer and Plant Viewer for Mobile by accessing the website www.auroravision.net and click on “Register with Plant Viewer” button (mainly for site owners).

Configurable relay

The inverter is equipped with a configurable switching relay, which can be used in different operating configurations that can be set using the internal webserver. A typical example of application is closing the contact when an alarm is triggered.

Remote switch-on/switch-off

This command can be used to perform a software switch off/switch on the inverter via an external (remote) command (see chapter 5 and 7 for more details).



The switching on of the inverter, when this functionality is activated, besides being dictated by the presence of normal parameters which allow the inverter to be connected to the grid, also depends on the external control for switching on/off.

Reactive power feed into the grid

The inverter is able to produce reactive power and can feed this power into the grid via the phase factor setting (see chapter 5 for more details). Power feeding modes vary according to the country of installation and the grid companies.

Limiting the active power fed into the grid

The inverter can limit the amount of active power fed into the grid by the inverter to the desired and settable value (see chapter 5 for more details).

Overvoltage surge arrester monitoring

The inverter monitors the status of the overvoltage surge arresters, and generates a warning in the event of a fault (viewable via monitoring system, internal web user interface or Installer Mobile APP).

Data transmission and control

Embedded multi communication interfaces (WLAN, Ethernet, RS485) combined with a Sunspec compliant Modbus protocol (RTU/TCP) allow the inverter to be easily integrated with any third party monitoring and-control systems that support the same Sunspec standard.



Please contact the ABB technical support or get access to Sunspec alliance website for further information on Modbus Sunspec products.

Communication connection diagrams

The communication connection diagrams shows how the integrated ethernet and wireless board allows the locally or remotely connection to the inverter.

Communication interface

The inverter provide the following communication interface:

- Integrated Wi-Fi channel (IEEE 802.11 b/g/n@2.4GHz)

The use is recommended to access wirelessly to embedded web server by using any WLAN standard device (PC, tablet, smartphone) for commissioning and parameter setting

- 2x Ethernet ports (10/100BaseTx - external RJ45 plugs)

The ports are configured by default for enabling daisy chain connection of the inverters over the Ethernet bus.

In order to improve the reliability of the communication with the inverters it is also allowed to create ring shape layout by using this Ethernet bus

- 3x RS485 ports (internally located)

Mainly recommended for replacement of old product or service operations.

Accessing to web server

The recommended way to access to the inverter web server is the Wi-Fi communication interface.

Any standard WLAN devices with a common browser can be used for this purpose.

- Once powered, the inverter will automatically create a wireless network (approx. 60 seconds after its switch-on) that will be visible as an Access Point from the user devices previously mentioned (tablet, smartphone, etc.).
- Enable the wireless connection on the device which is being used for the board setup (tablet, smartphone or PC) and connect it to the Access Point created by the inverter system: the name of the wireless network created by the system that the connection should be established with, will be: **ABB-XX-XX-XX-XX-XX-XX** where "X" is a hex digit of the wireless MAC address (MAC address can be found on the "Communication Identification Label" placed on the side of the inverter).
- When required Input the network password **PRODUCT KEY**



When prompted, type the "product key" (including the dashes: Example 1234-1234-1234-1234) as the network password to access the inverter's access point. The product key is printed on the "wireless identification label" located on the side of the inverter.

The access to the web server is allowed by user account and admin account (both protected by password) defined during the commissioning procedure.

In order to recover the user/admin password push "forgot password" button and follow the procedure.

Ethernet bus connection

By default the 2 Ethernet ports of the inverters are already configured for enabling communication over daisy chain layout.

Once physically connected the inverters do not need specific settings: after the first time the inverter is turned on, the inverters automatically get all needed network parameters with or without the presence of DHCP server. If an internet connection is available on site the inverters are automatically configured to transmit telemetry data to Aurora Vision Cloud without the need of installing any additional devices (logging capability are already integrated into the inverter by default)



Aurora Vision Plant Management platform is the ABB cloud solution allowing customer to remotely monitor and manage its own solar plants. Please refer to <http://new.abb.com/power-converters-inverters/solar> or contact ABB technical support for further information on how getting an Aurora Vision account

With the inverters connected over Ethernet daisy chain and with an available internet connection it will be always possible, via Aurora Vision Cloud, to upgrade remotely the firmware of the inverters.

In order to improve the communication services and allow reaching of all the inverters in the chain also in presence of fault it is recommended to create a ring shape layout by connecting both the first and the last inverters of the chain to the local Ethernet switch(as shown in the picture)

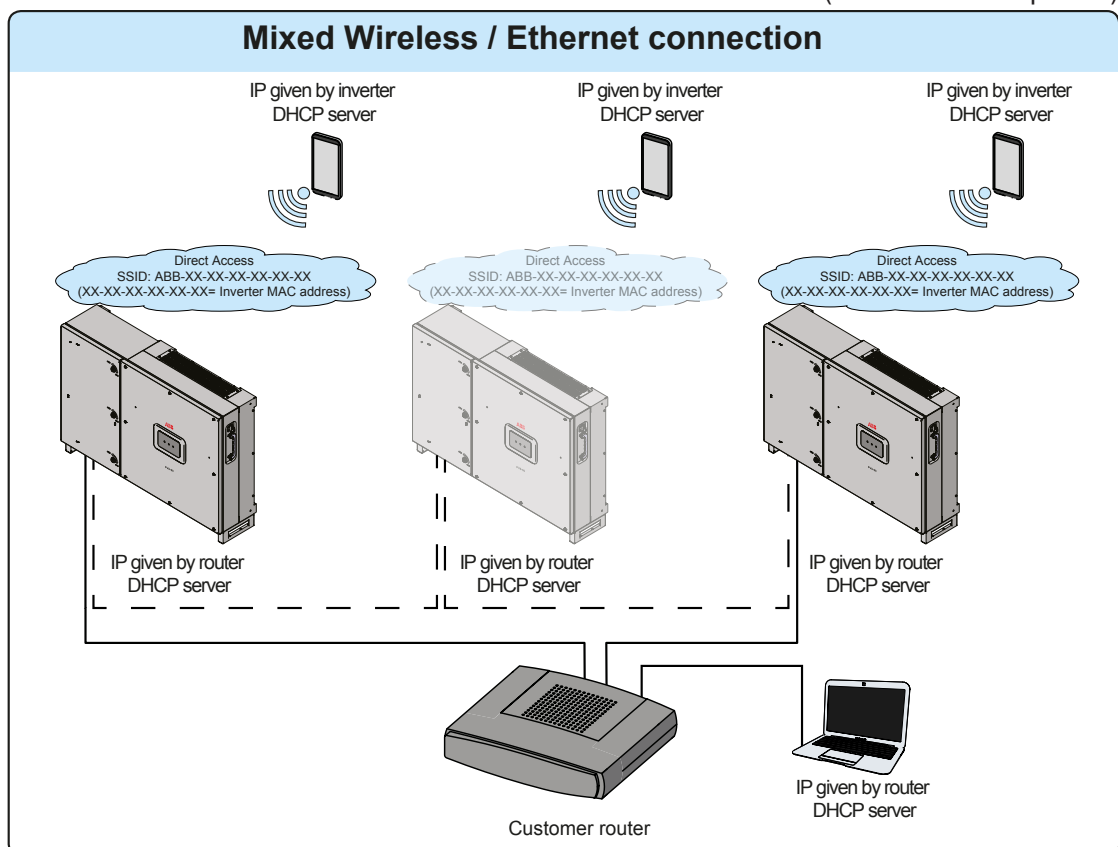

000862BG



Please refer to chapter 5 for further information about the installation.

Topographic diagram of the equipment

This new addition PVS family, with 3 independent MPPT and power ratings of up to 60 kW (480 V version), has been designed with the objective to maximize the ROI in large systems with all the advantages of a decentralized configuration for both rooftop and ground-mounted installations.

Design flexibility

The internal circuitry is with double stage conversion and therefore consists of:

- DC/DC input converter (booster)
- DC-AC output inverter

The DC-DC converter and the DC-AC inverter both work at a high switching frequency and are therefore small and relatively light.

Each input converter is dedicated to an array with a maximum power point tracking (MPPT) function in order to maximize the exportation of energy from the photovoltaic generator.

This inverter version is of the type without transformer, that is without galvanic isolation between the input and the output. This allows ultimately an increase in conversion efficiency.

The operation and the protection management of the inverter is controlled by two independent DSPs (Digital Signal Processors) and a central microprocessor.

The connection to the distribution grid is thus kept under control by two independent computers, in full compliance with the electric field norms both for power supply to the systems as well as security.

In doing all this, we guarantee optimal operation of the whole assembly and a high performance in all irradiation conditions and always ensuring full compliance with the relevant directives, standards and regulations.

Embedded multi communication interfaces (WLAN, Ethernet, RS485) combined with a Sunspec compliant Modbus protocol (RTU/TCP) allow the inverter to be easily integrated with any third party monitoring and control systems.



The diagram summarises the internal structure of the inverter.

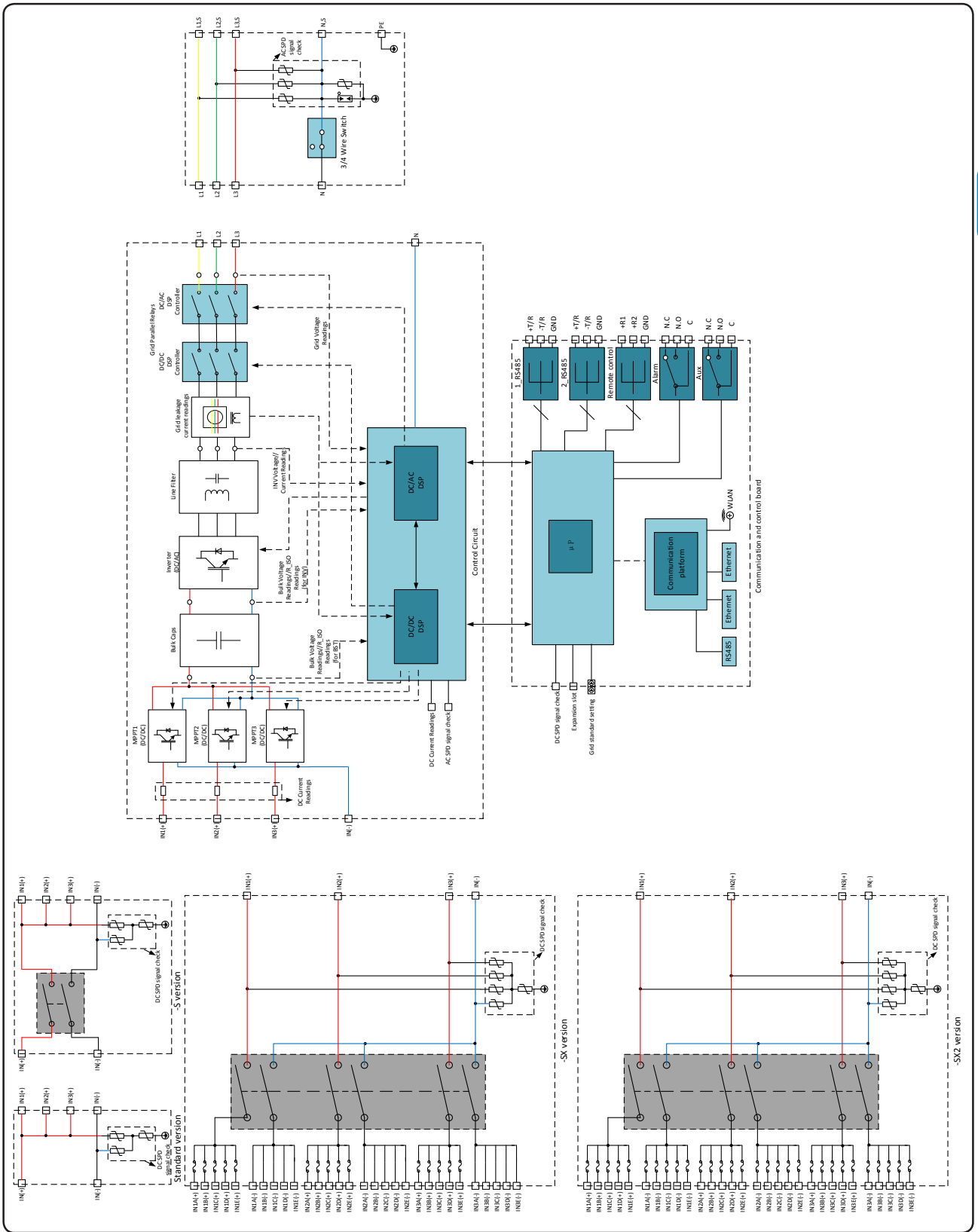

Safety devices

Anti-Islanding

In the event of a local grid outage by the electricity company, or when the equipment is switched off for maintenance operations, the inverter must be physically disconnected to ensure the protection of the people working on the grid, in accordance with the relevant national laws and regulations. To prevent possible islanding, the inverter is equipped with an automatic safety disconnection system called "Anti-Islanding".

The method used to ensure an active anti-islanding protection is: active frequency drift in combination with techniques RoCoF

Anti-islanding protection mechanisms are different depending on the grid standards, even if they all have the same purpose.

Ground fault of the photovoltaic panels

An advanced ground fault protection circuit continuously monitors the ground connection and disconnects the inverter when a ground fault indicating the fault condition by means of the red "GFI" LED on the LED panel on the front side (where the accessory is present).

Use this inverter with panels connected in "floating" mode, i.e. with no earth connections on the positive and negative terminals.

String fuses

The DC compartment can be equipped with string fuses are:

-SX version - Only positive side (+) string fuses ³⁵ are preinstalled

-SX2 version - Negative side (-) string fuses ³⁴ and the positive side (+) string fuses ³⁵ are preinstalled.

The fuses protect the appliance from currents exceeding the limit value independently for each string.

The sizing of the fuses must therefore be carefully assessed during installation.

Overvoltage surge arresters

As additional protection to prevent damage caused by lightning and electrostatic induction phenomena, all versions are equipped with type 2 overvoltage arresters (optional -SX2 version Type I+II on the DC side).

Other safeguards

The inverter is equipped with additional protective devices to ensure safe operation in any circumstance. These protections include:

- Constant monitoring of the grid voltage to ensure that voltage and frequency values remain within operating limits;
- Internal temperature control to automatically limit the power if necessary to prevent overheating of the unit (derating).

The numerous control systems determine a redundant structure to ensure absolutely safe operations.



Safety information and instructions

The equipment has been manufactured in accordance with the strictest accident-prevention regulations and supplied with safety devices suitable for the protection of components and operators.



For obvious reasons, it is not possible to anticipate the great number of installations and environments in which the equipment will be installed. It is therefore necessary for the customer to appropriately inform the manufacturer about particular installation conditions.

ABB accepts no liability for failure to comply with the instructions for correct installation and cannot be held responsible for the upstream or downstream equipment.



It is essential to provide operators with correct information. They must therefore read and comply with the technical information provided in the manual and in the attached documentation.



The instructions provided in the manual do not replace the safety devices and technical data for installation and operation labels on the product, and they do not replace the safety regulations in force in the country of installation.

The manufacturer is willing to train staff, at its premises or on site, in accordance with conditions agreed to in the contract.



Do not use the equipment if you find any operating anomalies.

Avoid temporary repairs. All repairs should be carried out using only genuine spare parts, which must be installed in accordance with their intended use.

Liabilities arising from commercial components are delegated to the respective manufacturers.

Hazardous areas and operations

Environmental conditions and risks

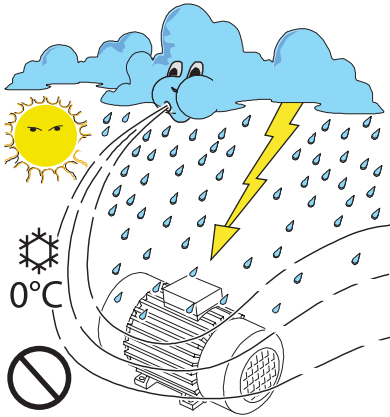

The device can be installed outdoors, but only in environmental conditions that do not prevent its regular operation. These conditions are listed in the technical data and in the installation chapter.

ABB IS NOT responsible for the disposal of the equipment: displays, cables, batteries, accumulators, etc., and therefore the customer must dispose of these items, which are potentially harmful to the environment, in accordance with the regulations in force in the country of installation.

The same precautions shall be adopted for dismantling the equipment.



The device is not designed to operate in environments that are particularly inflammable or explosive.

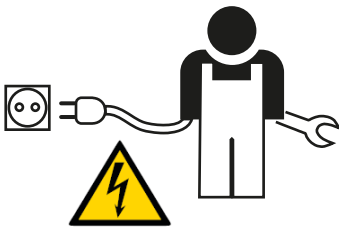

The customer and/or installer must appropriately train operators or anyone who may come into close proximity of the equipment, and highlight, with notices or other means where necessary, the hazardous areas or operations at risk: magnetic fields, hazardous voltages, high temperatures, possible discharges, generic hazard, etc.

Signs and labels



The labels affixed on the equipment must strictly NOT be removed, damaged, defaced, hidden, etc.

The labels must be regularly cleaned and kept in sight, i.e. NOT hidden by foreign objects and parts (rags, boxes, equipment, etc.)

The technical data provided in this manual does not in any case replace that shown on the labels affixed on the equipment.

Thermal and electrical hazard

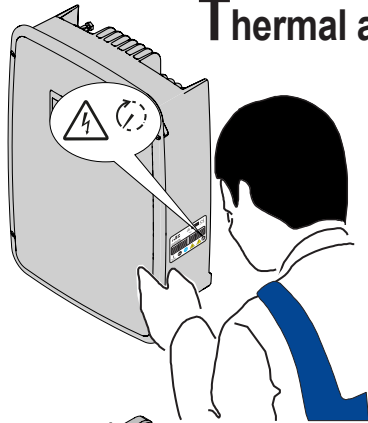

WARNING: the removal of guards or covers is only permitted after the voltage has been removed and time period indicated on the label has passed. This is to let the components cool down and allow the internal capacitors to discharge. Refer to “Inverter switch-off” chapter on this manual to know all the necessary step to safely operate on the inverter.

When the device has just been switched off, it may have hot parts as a result of overheating of the heated surfaces (e.g.: transformers, accumulators, coils, etc.) so be careful where you touch.

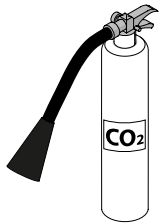

In the event of fire, use CO2 extinguishers and auto-extraction systems to extinguish the fire in closed environments.



Clothing and protection of personnel

ABB has done its best to eliminate sharp edges and corners, but as this is not always possible you are advised always to wear the clothing and personal protective equipment provided by the employer.



Personnel must not wear clothes or accessories that could start fires or generate electrostatic charges or, in general, clothing that can compromise personal safety.



All operations on the equipment must be performed with adequately insulated clothing and instruments.

E.g.: insulating gloves, class 0, RC category

Maintenance operations may only be performed after the equipment has been disconnected from the grid and from the photovoltaic generator. Refer to “Inverter switch-off” chapter on this manual to know all the necessary step to safely operate on the inverter.

Staff must NOT go near the equipment with bare feet or wet hands.

The maintenance technician must in any case ensure that no one else can switch on or operate the device during the maintenance operations, and should report any anomaly or damage due to wear or ageing so that the correct safety conditions can be restored. Refer to “Inverter switch-off” chapter on this manual to know all the necessary step to safely operate on the inverter.

The installer or maintenance technician must always pay attention to the work environment, ensuring that it is well-lit and there is enough room to ensure an escape route.

During installation, **consider that the noise emitted based on the environment** could possibly exceed the legal thresholds (less than 80 dBA), therefore, suitable ear protection must be worn.



Residual risks



Despite the warnings and safety systems, there are still some residual risks that cannot be eliminated.

These risks are listed in the following table with some suggestions to prevent them.

Table of residual risks

RISK ANALYSIS AND DESCRIPTION	SUGGESTED REMEDY
 Noise pollution due to installation in unsuitable environments or where staff work permanently.	Reassess the environment or the place of installation.
Suitable local ventilation that does not cause overheating of the equipment and is sufficient not to create discomfort to people in the room.	Restore suitable ambient conditions and air the room.
External weather conditions, such as water seepage, low temperatures, high humidity, etc.	Maintain ambient conditions suitable for the system.
Overheating of surfaces at temperature (transformers, accumulators, coils, etc.) can cause burns. Also be careful not to block the cooling slits or systems of the equipment.	Use suitable protective equipment or wait for the parts to cool down before switching on the equipment.
Inadequate cleaning: compromises cooling and does not allow the safety labels to be read.	Clean the equipment, labels and work environment adequately.
Accumulation of electrostatic energy can generate hazardous discharges.	Ensure the devices have discharged their energy before working on them.
Inadequate training of staff.	Ask for a supplementary course.
During installation, temporarily mounting the equipment or its components may be risky.	Be careful about and disallow access to the installation area.
Accidental disconnections of the quick-fit connectors with the equipment in operation, or wrong connections, may generate electric arcs	Be careful about and disallow access to the installation area.

General conditions

Some recommendation apply only to large size product or multiple small size product packaging.

Transport and handling



Transport of the equipment, especially by road, must be carried out with means for protecting the components (in particular, the electronic components) from violent shocks, humidity, vibration, etc.

During handling, do not make any sudden or fast movements that can create dangerous swinging.

Lifting



ABB usually stores and protects individual components by suitable means to make their transport and subsequent handling easier, but as a rule, it is necessary to utilize the experience of specialized staff in charge of loading and unloading the components.

The ropes and equipment used for lifting must be suitable for bearing the weight of the equipment.

Do not lift several units or parts of the equipment at the same time, unless otherwise indicated.

Unpacking and checking

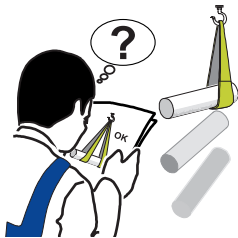
Packaging elements (cardboard, cellophane, staples, adhesive tape, straps, etc.) may cause cuts and/or injuries if not handled with care. They should be removed with the proper equipment.

The components of the packaging must be disposed on in accordance with the regulations in force in the country of installation.

When you open an equipment package, check that the equipment is undamaged and make sure all the components are present. If you find any defects or damage, stop unpacking and consult the carrier, and also promptly inform ABB Service.

Storage

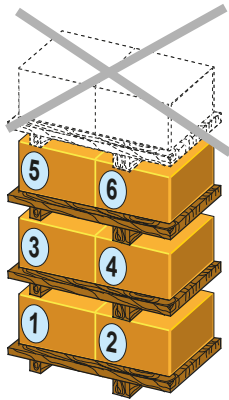

If the package is stored correctly, it can withstand a maximum load of 6 stacked devices (divided into 3 pallets).

DO NOT stack with equipment or products other than those indicated.

Weight of the equipment



Table: Weights

	Weight (kg)	Lifting points (n°#)
PVS-50-TL	70kg/159lbs	4 (2 handles and 2 lower support)
PVS-60-TL		

Types of lifting

Because of its weight, the inverter must be lifted by two people or alternatively using suitable lifting equipment.



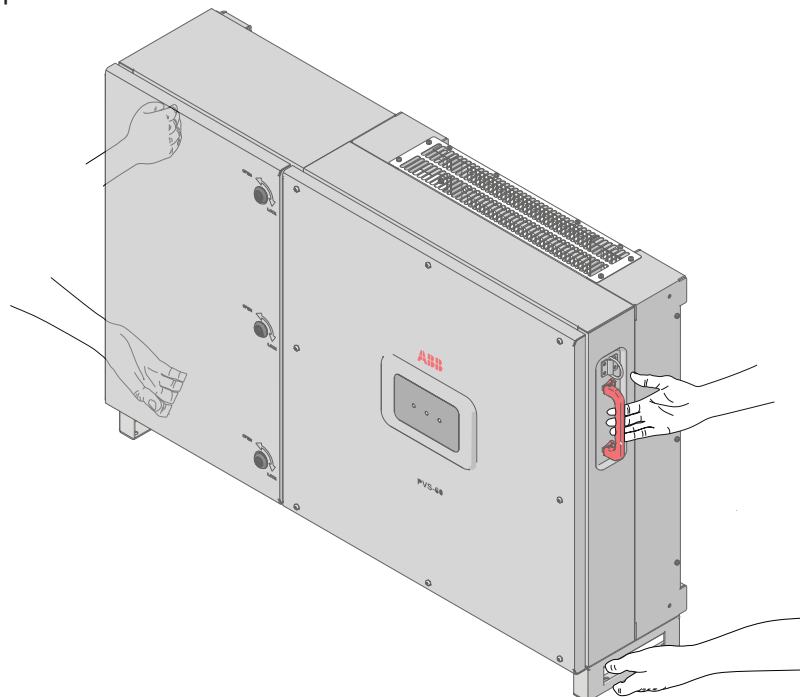



In order to make the inverter easier to manage, handles ¹⁴ and lower support ²⁴ should be used to lift the inverter.

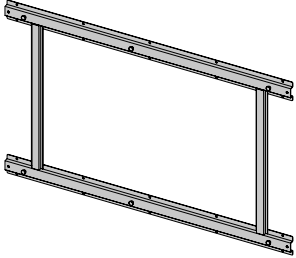
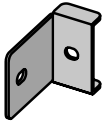
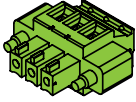
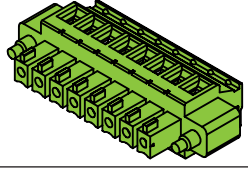
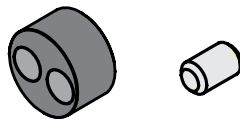

The lateral lifting rings should be used only to pull out the inverter from the box.

List of components supplied

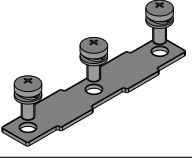
Supplied with the inverter are all the components required to correctly install and connect the inverter

Components available for all inverter models		Qty
	Mounting bracket ①	1
	Locking brackets ②	4
	Connector for connection of the configurable relay	2
	Connector for connecting the communication and control signals	2
	Two-hole gasket for service cable glands ⑬ PG 21 + cap	2 + 2
	M6 screw for securing the: - Protective earth terminal (internal) ⑳ - Protective earth terminal (external) ⑱	2
	M6 toothed washer for securing the: - Protective earth terminal (internal) ⑳ - Protective earth terminal (external) ⑱	4
	Wireless antenna	1
	Bar for parallel input channels configuration + M5x12 screws (equipped with cut and flat washer)	1 + 3
	Key for front cover key-lock ⑳	1
	Technical documentation	



General conditions

The device is intended to be installed in a suitable plant for its use and its purpose. All the installation instruction described in this chapter must be followed considering the plant structure where the device is intended to be installed. Its performance therefore depends on the correctness of the installation.

The installation operations must be carried out by qualified personnel and it is mandatory to adhere to the indications provided in this manual, the diagrams and the enclosed documentation, paying attention to follow the installation sequence exactly as described in this manual.



Staff authorised to carry out the installation must be specialised and experienced in this job. They must also have received suitable training on equipment of this type.



The installation must be performed by qualified installers and/or licensed electricians in accordance with the existing regulations in the country of installation.



The removal of the inverter panels/covers allows access to the area dedicated to service personnel (the operator is not authorized to access this area)



Connection of the photovoltaic system to an electric installation connected to the distribution grid must be approved by the electricity provider.



The installation must be carried out with the equipment disconnected from any voltage sources. Refer to “Inverter switch-off” chapter on this manual to know all the necessary step to safely operate on the inverter.



When the photovoltaic panels are exposed to sunlight they provide continuous DC voltage to the inverter.

Installation site and position

- Consult the technical data to check the required environmental conditions (protection rating, temperature, humidity, altitude, etc.)
- Installation of the unit in a location exposed to direct sunlight is acceptable. Except for the version equipped with a display.
- Do not install in small closed rooms where air cannot circulate freely
- Always ensure that the flow of air around the inverter is not blocked so as to prevent overheating.
- Do not install near flammable substances (minimum distance 3 m)
- Do not install on wooden walls or near flammable substances.
- Do not install in rooms where people live or where the prolonged presence of people or animals is expected, because of the high noise that the inverter produces during operation. The level of the sound emission is heavily influenced by where the appliance is installed (for example: the type of surface around the inverter, the general properties of the room, etc.) and the quality of the electricity supply.
- Installation of these models can be carried out vertically or horizontally, with a maximum inclination as indicated in the figure.

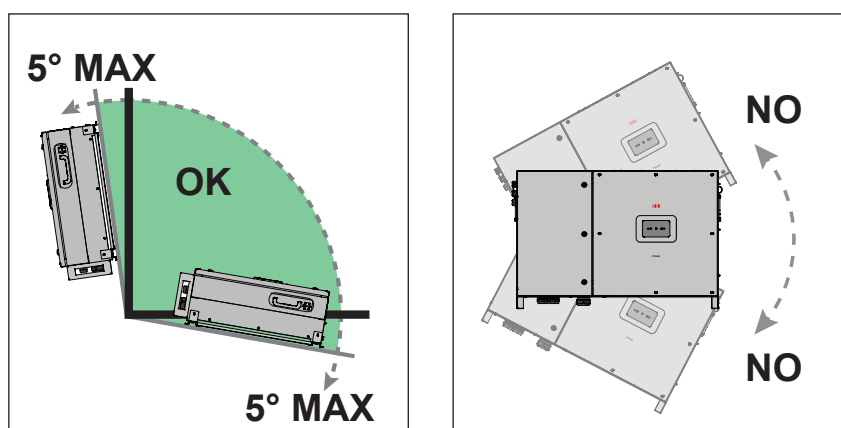

- Hardware and software maintenance on device entails opening the front cover. Check that the correct installation safety distances are observed in order to allow routine check and maintenance operations.
- Install on a wall or strong structure suitable to bear the weight
- If possible, install at eye-level so that the status LEDs can be seen easily.
- Install at a height which takes into consideration the weight of the appliance and in a position which is suitable for servicing, unless suitable means are provided to carry out the operation
- Final installation of the device must not compromise access to any disconnection devices that may be located externally.

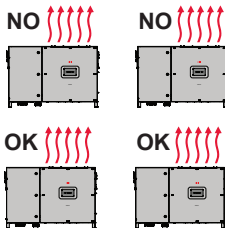
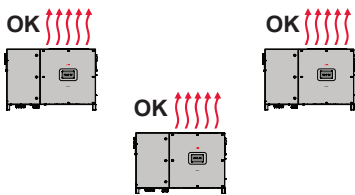
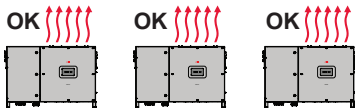
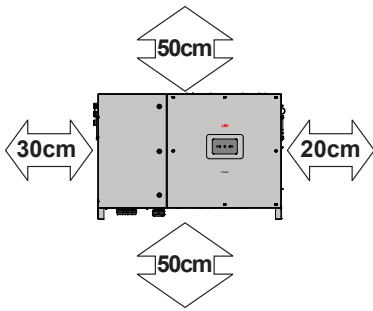

- Respect the minimum distances from objects around the inverter that could prevent the inverter installation and restrict or block the air flow. The wiring boxes are connected to the inverter using quick fit connectors which require sufficient space in order for them to be connected and disconnected easily

- Provide sufficient working space in front of the inverter that allows to make connections on the wiring box.

- In case of multiple installation position the inverters side by side keeping the minimum distances (measured from the outer edge of the inverter) for each inverter.

- If the space available does not allow this arrangement, position the inverters in a staggered arrangement as shown in the figure so that heat dissipation is not affected by other inverters below.

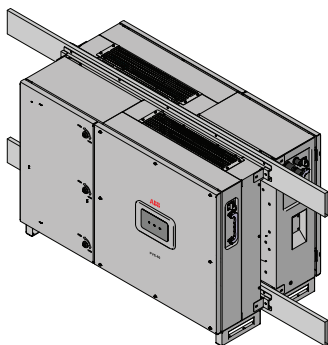
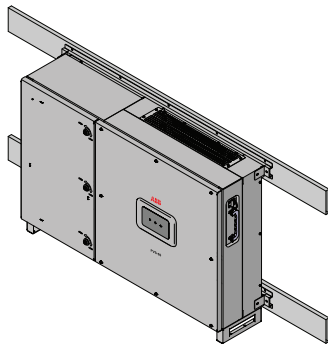

- The vertical installation is also permitted on a structure which must be composed of a support for the attachment of the bracket and one for the support of the rear pins.

- The vertical installation of two inverters positioned back to back is also permitted on a structure which must be composed of a support for the attachment of the brackets and one for the support of the rear pins.



Please refer to the warranty terms and conditions to evaluate any possible warranty exclusions due to improper installation.

Wireless signal environmental checks

The wireless communication is used to perform commissioning and monitoring on the inverter. The WLAN board of the inverter uses radio waves to transmit and receive data, it is therefore important to assess this factor in order to have optimal installation.

- Walls in reinforced cement and surfaces covered in metal (doors, shutters, etc.) can markedly reduce the reach of the device which even in optimal conditions, should be of approximately 50 metres in free space.
- It is therefore recommended that before installing the inverter, the strength of the wireless signal is checked, using a mobile device (smartphone, tablet or notebook) and connecting to the wireless router from a position which is close to the installation site of the inverter.

The radio signal level between the inverter and the wireless router can be improved in a number of ways:

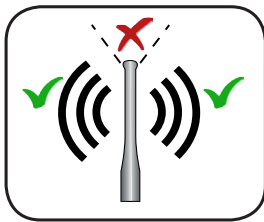

1. Change the direction of the antenna.

The antenna has a dead zone at its tip, which should not be positioned facing the wireless router, as shown in the figure.

2. Find a new position for the router considering the different types of materials which the radio signal will have to pass through:

Material	Relative signal reduction
Open field	0% (strength of approximately 50 metres)
Wood / Glass	From 0 to 10%
Stone / Plywood	From 10 to 40%
Reinforced concrete	From 60 to 90%
Metal	Up to 100 %

The quality of the RF signal can be assessed during the installation stage where the signal is displayed in dBm.

3. Install a wireless signal repeater and place it in an area between the inverter and the router, trying to make sure that the most critical obstacles are avoided.



Installations above 2000 metres



On account of the rarefaction of the air (at high altitudes), particular conditions may occur that should be considered when choosing the place of installation:

- Less efficient cooling and therefore a greater likelihood of the device going into derating because of high internal temperatures.
- Reduction in the dielectric resistance of the air which, in the presence of high operating voltages (DC input), can create electric arcs (electrical discharges) that may damage the device.

As the altitude increases, the failure rate of some electronic components increases exponentially because of cosmic radiation.



The inverter operates normally up to 2000 meters.

Between 2000 and 4000 meters the inverter works in derating (second curve derating by altitude).

Above 4000 meters the installations are forbidden.

Installations with a high level of humidity



Never open the inverter in the case of rain, snow or a level of humidity >95%.

Always carefully seal all unused openings.

Even though the device is equipped with an anti-condensation valve, air with extremely high levels of humidity can lead to the creation of condensation inside the inverter.

As the inverter is almost completely insulated from the outside, condensation can also form after installation in certain weather conditions.

Mounting of the inverter on the bracket

The mounting bracket can be used to install the inverter on a vertical or horizontal support.

- Position the bracket ① perfectly level on the support and use it as drilling template.

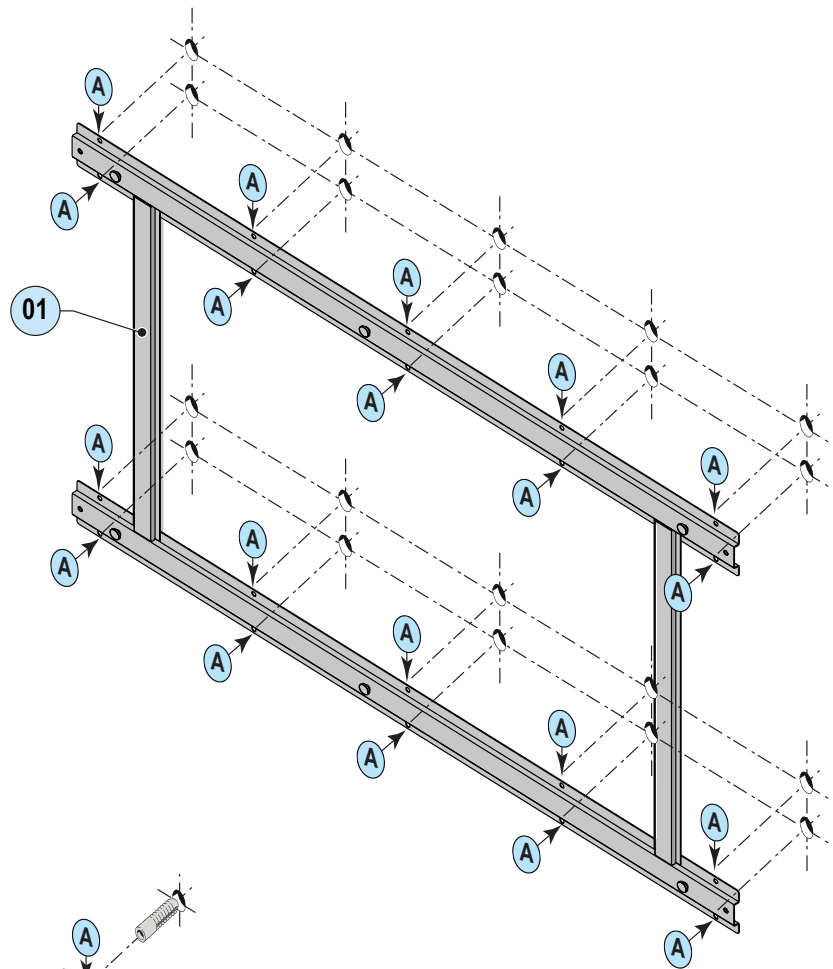

- It is the installer's responsibility to choose an appropriate number and distribution of attachment points. The choice must be based on the type of support (wall, frame or other support), the type of anchors to be used, and their ability to support 4 times the inverter's weight ($4 \times 70\text{Kg} = 280\text{Kg}$ for all models).

Attach the bracket to the wall with at least 10 attachment screws. Depending on the type of anchor chosen, drill the required 10 holes (minimum) (A) to mount the bracket. Put at least four screws in the upper side and at least four in the lower side (see example in the illustration)

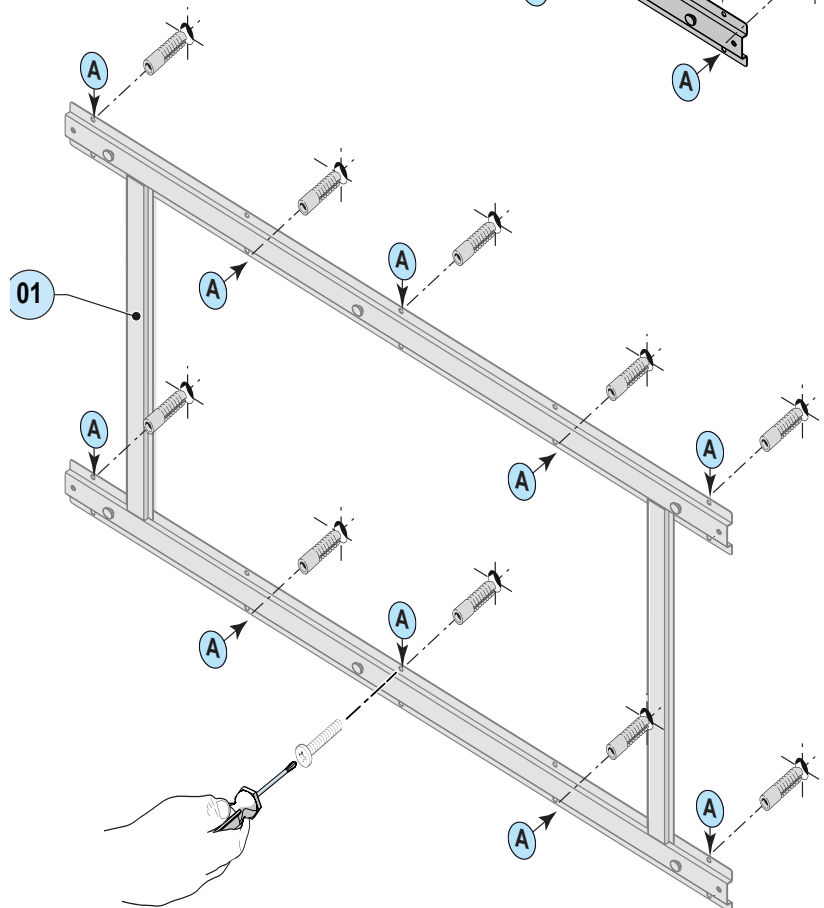

- Fix the bracket to the support.

- Lift the inverter up to the bracket using the handles 14, or another appropriate lifting device. The inverter is pre-equipped with lower support 24 which allow it to be temporarily put vertically on the floor to make it easier the lifting.



Risk of injury due to the heavy weight of the equipment.

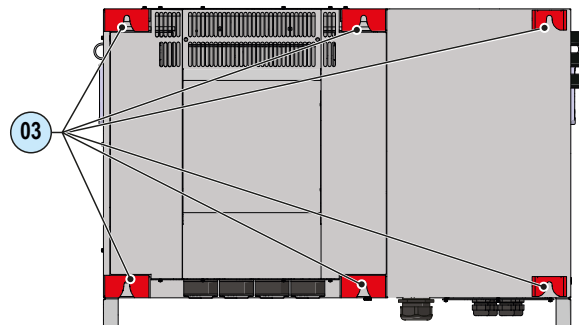
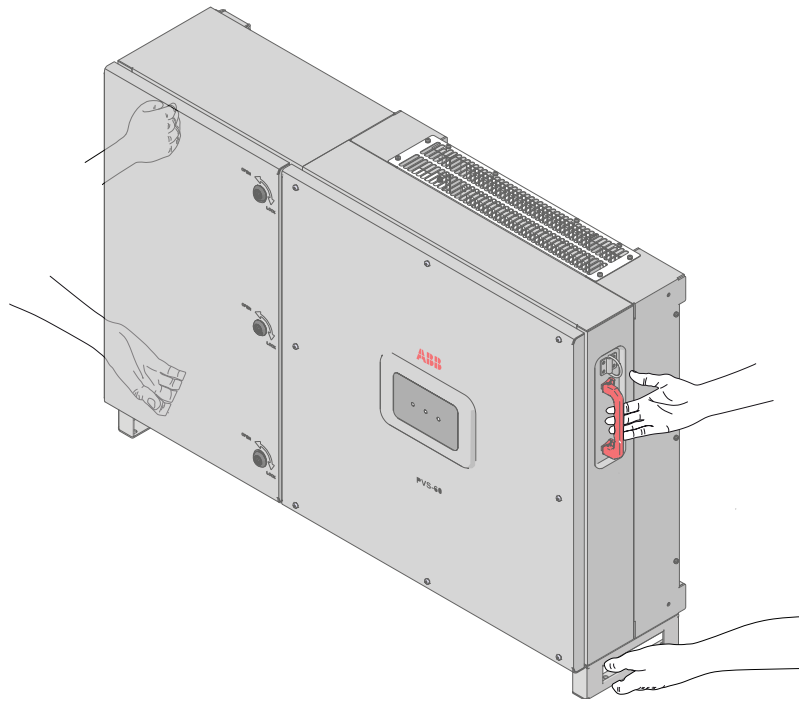

- Insert the heads of six anchor point 03 present on the bracket into the slots on the rear of the inverter.

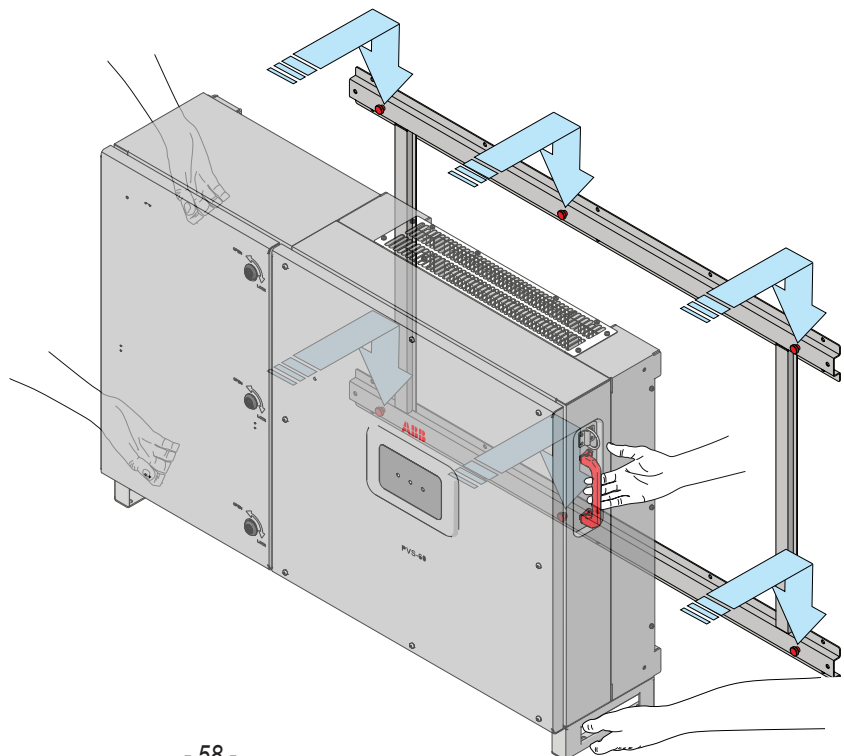

- Install the 4 fixing bracket on the 4 corner of the inverter (using 8 screws)

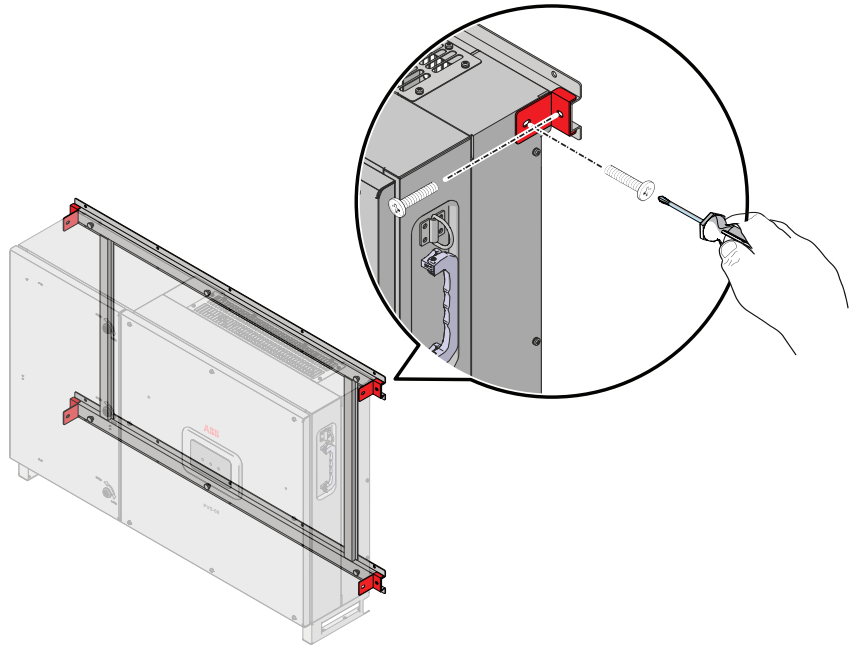

- Remove the protective cover from the connector of the wireless antenna located on the left side of the inverter. Install the wireless antenna by screwing it into the specific connector ⑩.

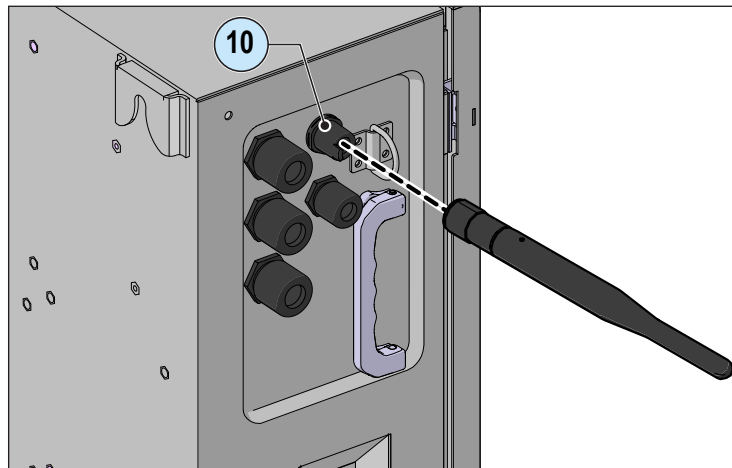

- Open the wiring box front cover turning the 3 key-lock ③ in "OPEN" position and proceed with the wiring and connections depending on the model.

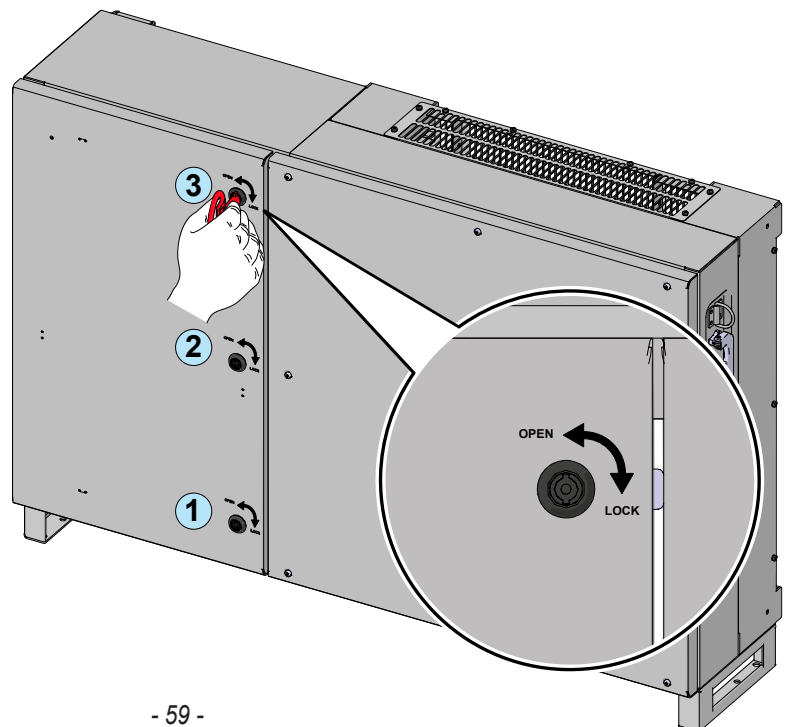

Grid output connection (AC side)

The inverter must be connected to a three-phase system with the center of the star connected to ground. To connect the inverter to the grid is possible to choose between the four-wire connection (3 phases + neutral) and the three-wire connection (3 phases).

In any case, the inverter's earth connection is mandatory.

The cable to be used can be five-pole (four-wire configuration), or four-pole (three-wire configuration).

Characteristics and sizing of the protective earth cable

ABB inverters must be earthed via the terminal with the protective earth symbol \oplus and using a cable with an appropriate conductor cross-section for the maximum ground fault current that the generating system might experience. There are 2 earth connection point:

- Protective earth terminal (internal) $\textcircled{37}$. It is positioned near to AC screw terminal block inside the inverter mechanics.
- Protective earth terminal (external) $\textcircled{16}$. It is positioned on the external left side of the inverter mechanics.



Any failure of the inverter when it is not connected to earth through the appropriate terminal is not covered by the warranty.

In compliance with standard IEC 62109 it is necessary:

- Install a earthing cable in one of the protective earth terminal with a minimum section as indicated in the table below:

Cross-sectional area of phase conductors (S) (mm ²)	Minimum cross-sectional area of the protective earthing conductor (mm ²)
$S \leq 16$	S
$16 < S \leq 35$	16
$35 < S$	S/2



The value on this table are valid only if the protective earthing conductor is made of the same metal as the phase conductors. If this is not so, the cross-sectional area of the earthing conductor is to be determined in a manner which produces a conductance equivalent to that which results from the application of this table.

- It is possible to install a second earthing cable (with the same section as the first one) positioning it in the protective earth terminal not used. Installation of a second protective earth cable is also required by regulations in force in certain countries of installation.



If necessary, carefully read the instructions provided in the paragraph "Installation of the second protective earthing cable".

Installation of the second protective earthing cable

The installation of a second earth cable may be required by the regulations of the country of installation. In making the connection, the following conditions must be fulfilled:

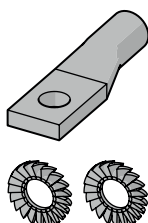

1. the ground cable must be secured to one of the dedicated connection points and identified by the symbol ⊕
2. use a M6 cable lug .
3. the cable lug must be installed between two toothed washers
4. Secure the cable lug using the screw and the two washers tightening to a torque of 11Nm.

Residual current protection device

Based on the requirements of the installation country and plant configuration could it be necessary to install a residual current protection device to protect the AC line between the inverter and the grid connection point.

The residual current protection device must meet the following characteristics:



	PVS-50-TL	PVS-60-TL
Type	A / AC	
Sensibility	500mA	600mA

In accordance with article 712.413.1.1.1.2 of Section 712 of IEC Standard 64-8/7, we hereby declare that, because of their construction, ABB inverters do not inject ground fault direct currents.



In the case of systems which consist of several inverters connected to a single switch with differential protection it is recommended that a device is installed which allows the adjustment of the tripping value and the tripping time.

Load protection switch (AC disconnect switch)

To protect the AC connection line of the inverter, an overcurrent protection device with the following features must be installed:

	PVS-50-TL	PVS-60-TL
Type	Automatic circuit breaker with differential thermal-magnetic protection	
Voltage/current rating	100 A / 400 V	100 A / 480 V
Magnetic protection characteristic	B/C	
Number of poles	3/4	

Characteristics and sizing of the line cable

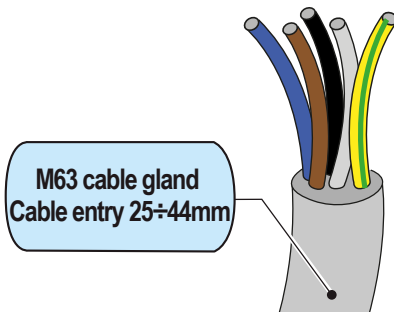

The cross-section of the AC line conductor must be sized in order to prevent unwanted disconnections of the inverter from the grid due to high impedance of the line that connects the inverter to the power supply; If the impedance is too high it causes an increase in the AC voltage which, on reaching the limit set by the standards in the country of installation, causes the inverter to switch off.

The table shows the maximum line conductor length in relation to the section of the conductor itself:

Line conductor cross section (mm ²)	Line conductor maximum length (m)	
	PVS-50-TL	PVS-60-TL
25	36 m	43 m
35	52 m	62 m
50	75 m	90 m
70	106 m	127 m
95	144 m	173 m



The values are calculated in nominal power conditions, considering:

- loss of power along the line no greater than 1%
- use of copper cable, with HEPR rubber isolation and positioned in open air.

Connection to terminal block AC side



To avoid risks of electrical shock, all wiring operations must be carried out with the disconnect switch downstream of the inverter (grid side) off.

Be careful not to change round one of the phases with neutral!



Grounding is essential before connection to the power supply network.

To carry out the connections, a multicore cable (44 to 52mm diameter) must be passed through the single AC cable gland (18). Connection of AC cable is made to the AC output screw terminal block (38); the screw terminal block accepts cables with a maximum-cross section of 95 mm² (copper or aluminum).

AC cable installation:

- Open the wiring box front cover (04).
- Unscrew the AC cable gland (18)
- Introduce the cable with a suitable cross-section
- Connect the earth cable to the protective earth terminal (internal) (37) following to the sequence illustrated in the below figure and tightening it to a torque of 11Nm. A ring cable lug, suitable for a M6 size threaded insert, must be installed on the cable.

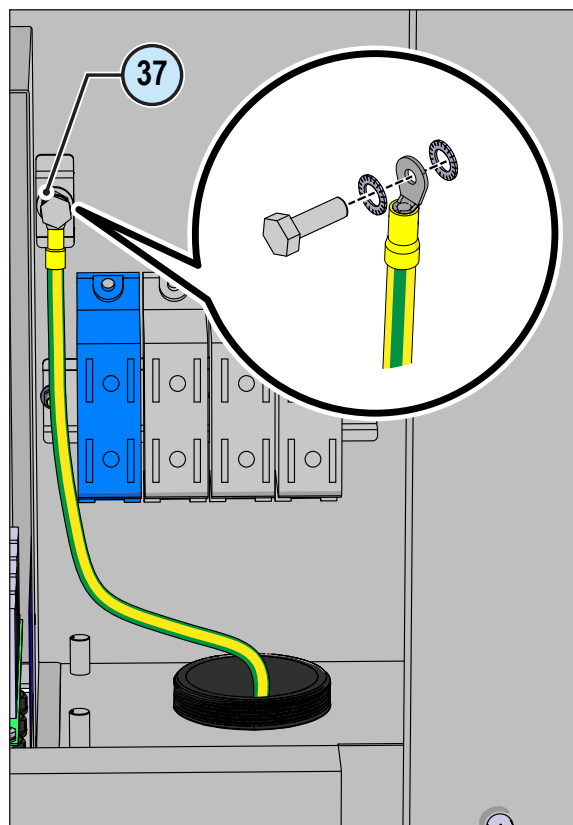
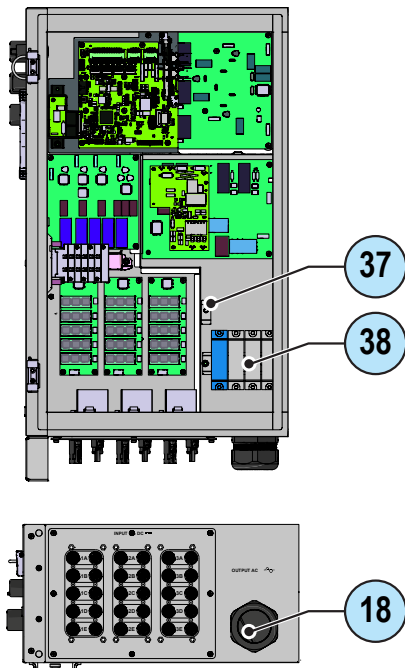

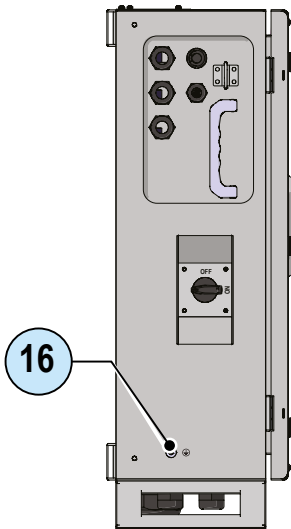

As alternative is possible to connect the earth cable to the protective earth terminal (external) ①⑥ positioned on the left side of the mechanics. As per the protective earth terminal (internal) ③⑦ following to the sequence illustrated in the below figure and tightening it to a torque of 11Nm. A ring cable lug, suitable for a M6 size threaded insert, must be installed on the cable.

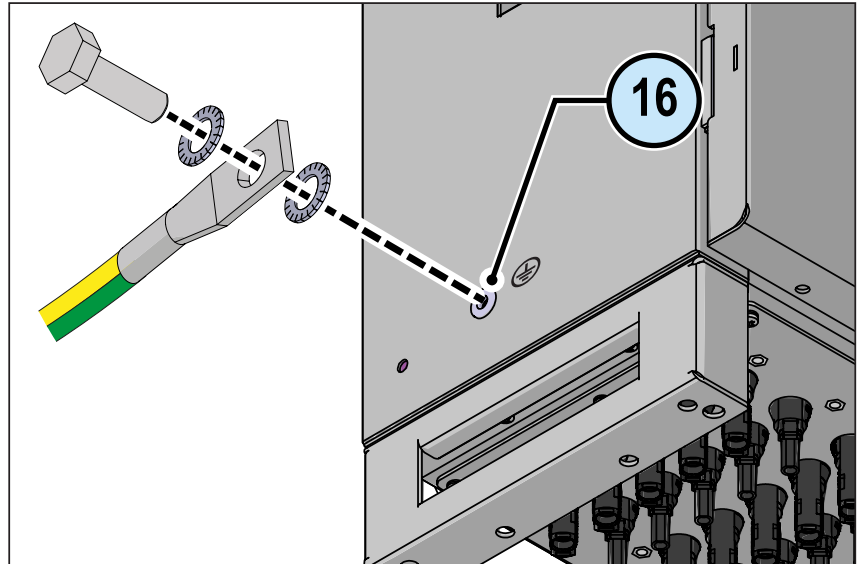

- Connect the Neutral, R, S, T wires to the respective terminals of the AC output screw terminal block ③⑧. Observe the connection sequence of the phases R, S, T indicated on the labels placed on the internal AC cables.



The inverter integrates a grid phase sequence check so that the connection to the grid is allowed only with the phase sequence as indicated in the labels. In case the phase sequence is not respected the inverter doesn't connect, triggering error E079 (also refer to Troubleshooting section).

Check datasheet of terminal block to indicate which kind of cables are allowed.

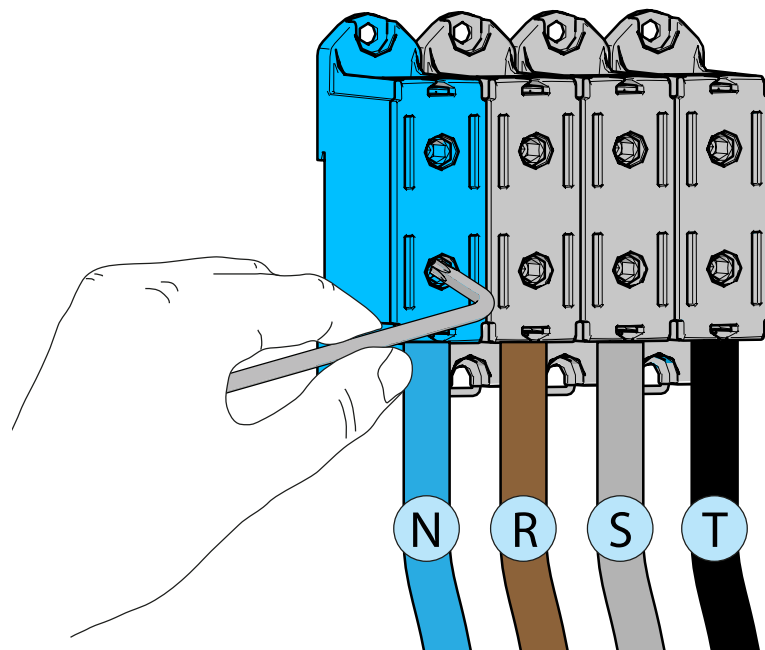

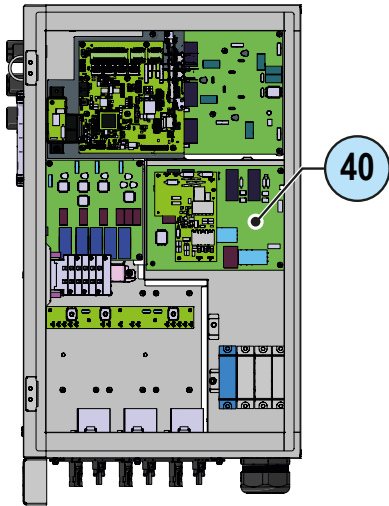

- Give each wire a pull test to confirm the connection is secure
- In the AC filter board (40) set the switch (S1) based on the configuration of the output connections:
 - **3WIRES** position. Three wires configuration (R+S+T)
 - **4WIRES** position. Four wires configuration (R+S+T+Neutral)

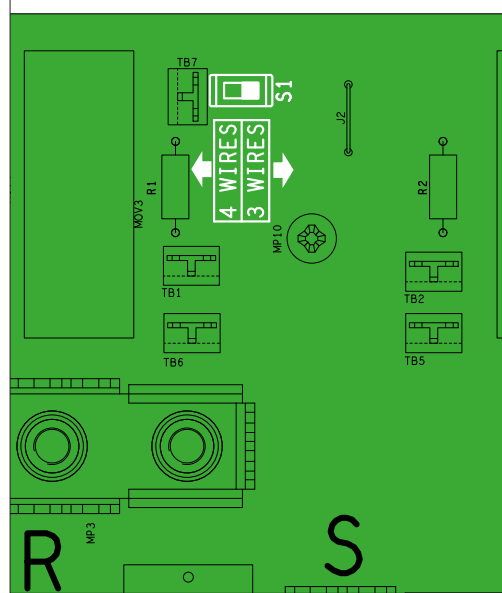

- Once connection to the AC output screw terminal block (38) has been completed, retighten (10.0 Nm torque) the cable gland firmly and check seal.

Operations preliminary to the connection of the PV generator

In order to perform safely the preliminary operations before the connection to the PV generator it is needed that the inverter is connected to the ground.

Checking of leakage to ground of the photovoltaic generator

Measure the voltage present between positive and negative pole of each string with respect to ground.

If a voltage is measured between an input pole and ground, it may be that there is a low isolation resistance of the photovoltaic generator and the installer will have to carry out a check to solve the problem.

Do not connect the strings if a leakage to ground has been detected, as the inverter might not connect to the grid.



Checking of strings voltage

Measure the voltage present between positive and negative pole of each string.

If the open circuit voltage of the string is near the maximum value accepted by the inverter, consider that low ambient temperatures cause an increase in the string voltage (different according to the photovoltaic module used). In this case it is necessary to carry out a check of the sizing of the system and/or a check on the connections of the modules of the system (e.g.: number of modules in series higher than the design number).



Input voltages higher than the maximum value accepted by the inverter (see technical data table) may occur the damage of the inverter.

Checking the correct polarity of the strings

Before wiring the strings, you must ensure that the voltage of each string complies with the correct polarity using a voltmeter.

Independent or parallel input channels configuration

The inverter -SX and -SX2 versions have three input channels (thus benefiting from three trackers for MPPT maximum power point tracking) which work independently of one another, which can be paralleled by leveraging a single MPPT.

Strings of photovoltaic modules having the same type and number of panels in series must be connected to each single channel; they must also have the same installation conditions (in terms of orientation to the SOUTH and inclination from the horizontal plane).

When connecting the three input channels in parallel, you must comply with the above requirements in order to benefit from the ability to leverage the full power of the inverter output on a single channel.

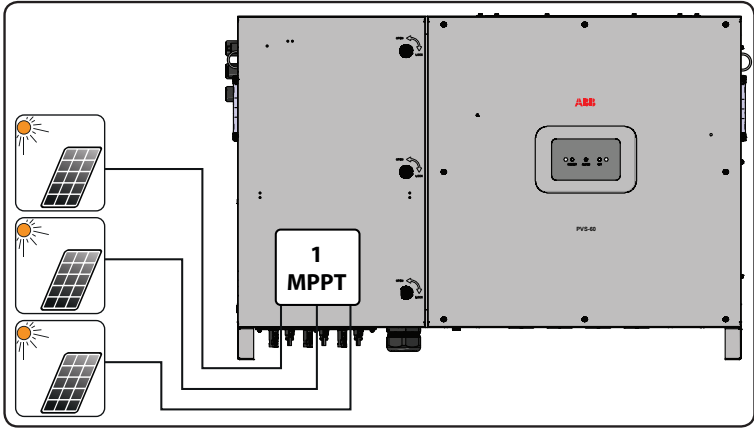

The multi MPPT structure however allows management of three photovoltaic generators which are independent of each other (one for each input channel), and which may differ between themselves with regard to installation conditions, type and number of photovoltaic modules connected in series. A necessary condition for the three MPPT to be used independently is that the photovoltaic generator connected to each of the inputs has a lower power than the power limit of the single input channel and a maximum current lower than the current limit of the single input channel.

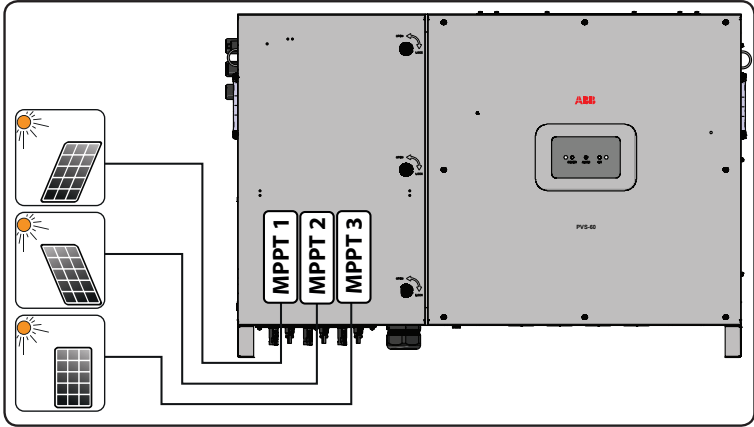

All input parameters that must be met for correct inverter operation are shown in the "technical data" table.

Channel configuration examples

PV generator characteristics	MPPT configuration	Notes
<p>The photovoltaic generator consists of strings having a different number of modules in series from each other.</p> <p>The photovoltaic generator consists of strings that have different installation conditions from each other.</p>	<p>MPPT configuration has to be INDEPENDENT</p>	<p>A NECESSARY condition so that the three MPPTs can be used in independent mode is for the photovoltaic generator connected to each of the inputs to have a power lower than the power limit of the single input channel AND a maximum current lower than the current limit of the single input channel.</p>
<p>The photovoltaic generator consists of strings having the same number of modules in series as each other.</p> <p>The photovoltaic generator consists of strings that have the same installation conditions, that is to say, all the strings have the same inclination from the horizontal and the same orientation to the SOUTH.</p> <p>The photovoltaic generator connected to each of the inputs has a power lower than the power limit of the input channel AND a current lower than the current limit of the input channel.</p>	<p>Possibility of choosing between the configuration with MPPT as INDEPENDENT or PARALLEL</p>	<p>A NECESSARY condition so that the three MPPTs can be used in independent mode is for the photovoltaic generator connected to each of the inputs to have a power lower than the power limit of the input channel AND a maximum current lower than the current limit of the input channel.</p> <p>An ADVISABLE (*) condition so that the three MPPTs can be connected in parallel is for the photovoltaic generator connected to the three inputs to consist of strings made by the same number of modules in series and for all the modules to have the same installation conditions.</p>
<p>(*) <i>This condition is advisable from the point of view of the energy production of the system, not from the point of view of inverter operation.</i></p> <p>The photovoltaic generator consists of strings having the same number of modules in series as each other.</p> <p>The photovoltaic generator consists of strings that have the same installation conditions, that is to say, all the strings have the same inclination from the horizontal and the same orientation to the SOUTH.</p> <p>The photovoltaic generator connected to each of the inputs has a power higher than the power limit of the input channel OR a current higher than the current limit of the input channel.</p>	<p>MPPT configuration has to be PARALLEL</p>	<p>A SUFFICIENT (*) condition so that the three MPPTs must be used in parallel mode is for the photovoltaic generator connected to each of the inputs to have a power higher than the power limit of the single input channel OR a maximum current higher than the current limit of the single input channel.</p> <p>An ADVISABLE (**) condition so that the three MPPTs can be connected in parallel is for the photovoltaic generator connected to the three inputs to consist of strings made by the same number of modules in series and for all the modules to have the same installation conditions.</p>
<p>(*) <i>This condition is sufficient from the point of view of the energy production of the system, not from the point of view of inverter operation.</i></p> <p>(**) <i>This condition is advisable from the point of view of the energy production of the system, not from the point of view of inverter operation.</i></p>		



Independent channel configuration (default configuration)

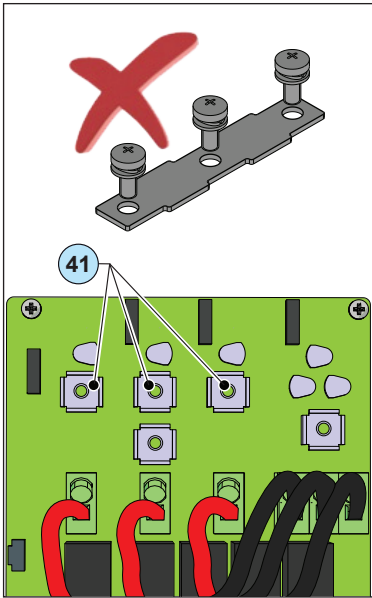

In the inverter -SX and -SX2 versions, the independent configuration of the input channels (MPPT) is set at the factory. This means that the parallel bar (supplied) must not be installed on the parallel MPPT connection points ④1, and that the software setting “Independent channel mode” should be performed on the inverter; this setting can be done by different way:

1. During the commissioning wizard phase (STEP 4)
2. In the dedicated section of the internal webserver “**Setup section > Setup DC side > Input mode**”
3. Using the inverter display (if available) on the dedicated menu “**Inverter>Settings> Input mode**”.

This configuration is not available for Standard and -S versions of the inverter.



Parallel channel configuration

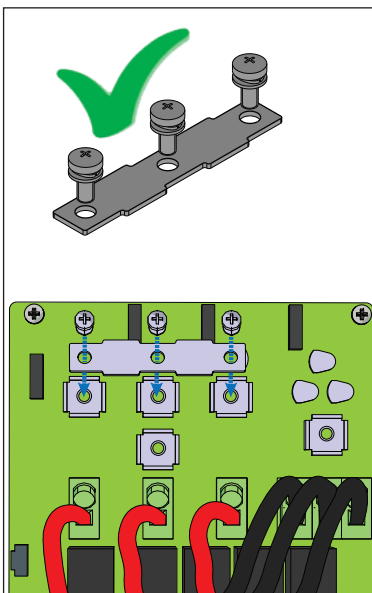

In the inverter -SX and -SX2 versions, the configuration of the input channels (MPPT) can be set in parallel. **Before carrying out this configuration, disconnect the strings from the inverter and open the AC disconnecter.** This means that the parallel bar (supplied) must be installed on the parallel MPPT connection points ④1, and that the software setting “parallel channel mode” should be performed on the inverter; this setting can be done by different way:

1. During the commissioning wizard phase (STEP 4)
2. In the dedicated section of the internal webserver “**Setup section > Setup DC side > Input mode**”
3. Using the inverter display (if available) on the dedicated menu “**Inverter>Settings> Input mode**”.

Input connection to PV generator (DC side)

After having carried out preliminary checks and therefore having verified that there are no problems in the photovoltaic system, and the channel configuration has been selected (parallel or independent) you may connect the inputs to the inverter.



According to the system configuration, check the correct setting of the channels to independent or in parallel mode. An incorrect setting of the input channels can lead to loss of energy production.



Comply with the maximum input current relating to the quick-fit connectors as indicated in the technical data.



Polarity inversion can cause serious damage. Check polarity before connecting each string!



When the photovoltaic panels are exposed to sunlight they provide continuous DC voltage to the inverter. To avoid risks of electrical shock, **all wiring operations must be carried out with the DC disconnect switch (internal or external to the inverter) OFF.**



Caution! The inverters referred to in this document are TRANSFORMERLESS. This type requires the use of insulated photovoltaic panels (IEC61730 Class A Rating) and the need to keep the photovoltaic generator floating with respect to ground: no terminal of the generator must be connected to ground.

The DC side connections are different according to the version used:

- the **Standard / -S** models use cable glands
- the **-SX / -SX2** models use quick fit connectors (one for each pole of each string).

On the **Standard / -S** versions, the connection in parallel of the strings (array composition) must take place upstream of the input in the inverter and must be made by technicians during installation.

The **-SX / -SX2** versions accept a direct single strings connection with connectors which are located on the outside of the mechanics.



To avoid risks of electrical shock,, all the connect operations must be carried out with the DC disconnect switch  and the external AC disconnect switch open.

Connection of inputs on the Standard and -S models

For these two models connection with the DC input screw terminal block ³⁹ is made by inserting the cables into the cable glands ¹⁷.

To carry out the connections, the cables (13 to 21mm diameter) must be passed through the DC cable gland ¹⁷. Connection of DC cables is made to the DC input screw terminal block ³⁹; the screw terminal block accepts cables with a maximum-cross section of 95 mm² (copper or aluminum).

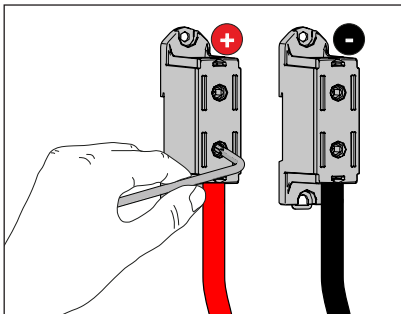
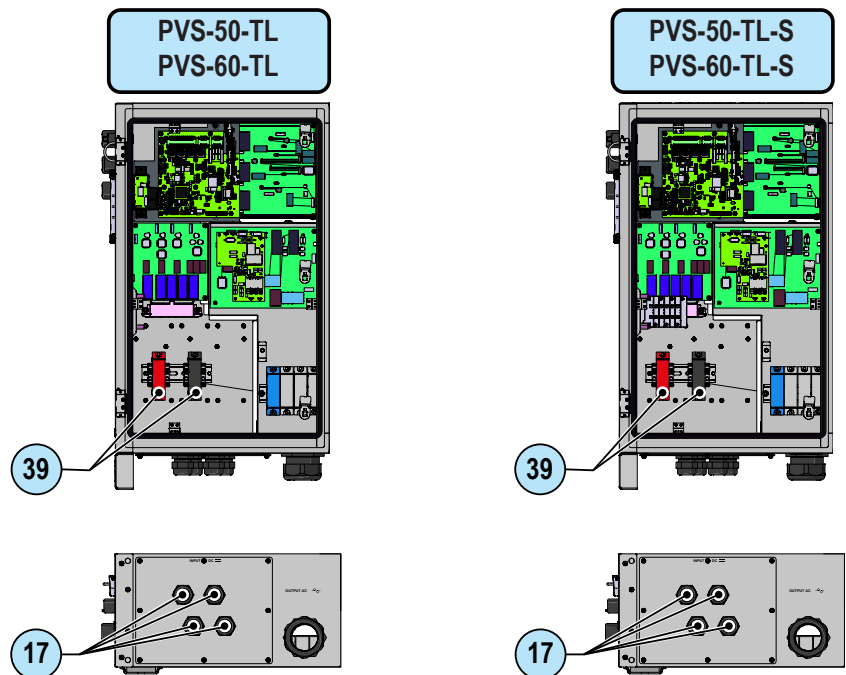

DC cable installation:

- Open the wiring box front cover ⁰⁴.
- Unscrew the DC cable gland ¹⁷
- Introduce the cable with a suitable cross-section
- Connect the cables to the terminals on the DC input screw terminal block ³⁹ with a tightening torque of 20 Nm. During this operation connect the cables with the right polarity.
- Once connection to the DC input screw terminal block ³⁹ has been completed, retighten (8.0 Nm torque) the cable gland firmly and check seal.
- Check datasheet of terminal block to indicate which kind of cables are allowed.

Connection of inputs on the -SX / -SX2 models

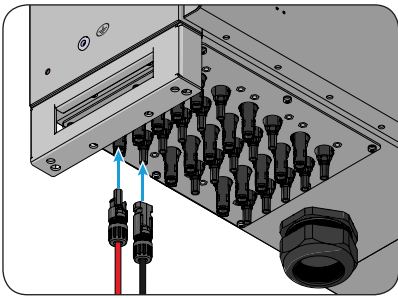

For the string connections on the -SX /-SX2 versions, it is necessary to use the quick fit connectors (usually Weidmüller PV-Stick or WM4, Multi-Contact MC4 and Amphenol H4) located on the bottom of the mechanic. The input connectors are divided into 3 groups (one group for each input channel) consisting of 5 pairs (4 pairs for the PVS-60-TL-SX-CN model) of quick fit connectors.

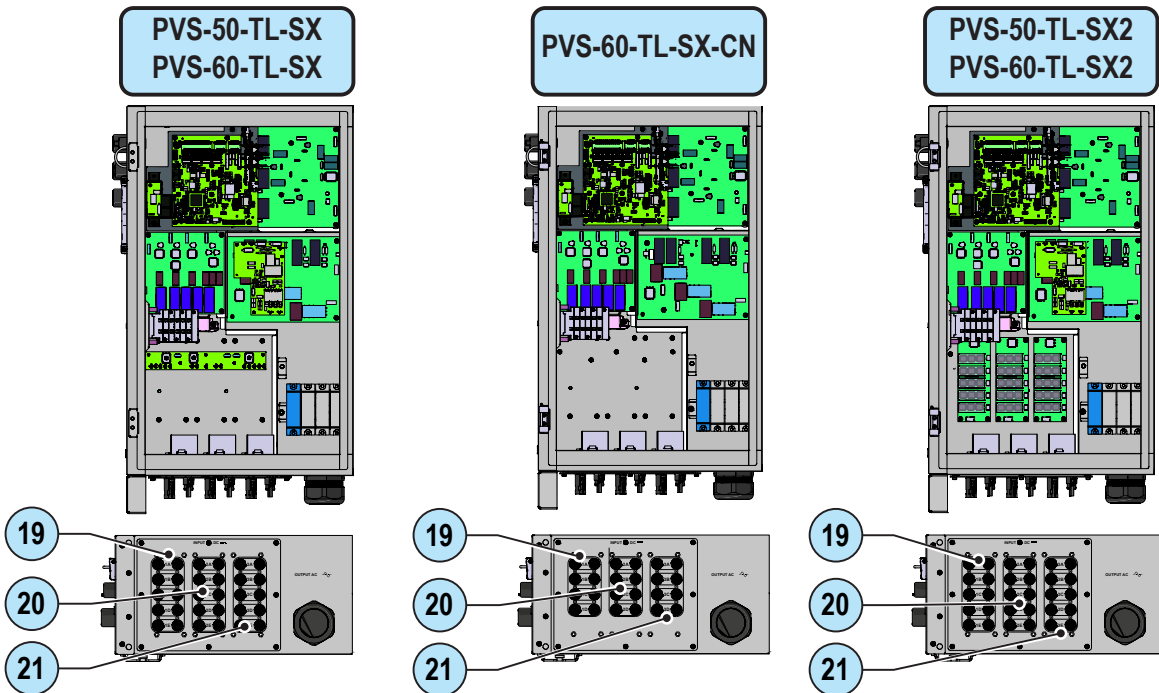

Refer to the document “String inverter – Product Manual appendix” available at www.abb.com/solarinverters to know the brand and the model of the quick fit connector. Depending on the model of the connector of the own inverter, it is necessary to use the same model and the respective counterpart (check the compliant counterpart on the website of the manufacturer or in ABB)



Using corresponding parts that are not compliant with the quick fit connector models on the inverter could cause serious damage to the unit and lead to invalidation of the warranty.

Connect all the strings required by the system, always checking the seal of the connectors.



If any string inputs are not required, you must ensure that covers are installed to the connectors, and install any which are missing.



This is necessary both for the inverter seal, and to avoid damage to the free connector which may be used at a later time.



In these versions, is MANDATORY to directly connect the individual strings coming into the inverter (do not make field switchboards for parallel strings). This is because the string fuses, situated on each input, are not rated to take strings in parallel (array). This operation can cause damage to the fuse and consequently malfunctioning of the inverter.

Installation procedure for quick-fit connectors

There are typically four different types of quick-fit connector models used on ABB inverters: Weidmüller PV-Stick or WM4, MultiContact MC4 and Amphenol H4.

Please refer to the document “*String inverters – Product manual appendix*” available at www.abb.com/solarinverters for information on the quick-fit connector brand and model used in the inverter.

The model of connectors installed on your inverter must be matched by the same model of the respective corresponding parts to be used (checking the conforming corresponding part on the manufacturer's website or with ABB).



Using corresponding parts that are not compliant with the quick-fit connector models on the inverter could cause serious damage to the unit and lead to invalidation of the warranty.



CAUTION: *To avoid damage to the equipment, when attaching cables, pay particular attention to polarity.*



1. WEIDMÜLLER PV-Stick quick-fit connectors

Installation of Weidmüller PV-Stick connectors does not require any special tooling.

- Strip the cable to which you want to apply the connector (after verifying that it complies with the connector limits).

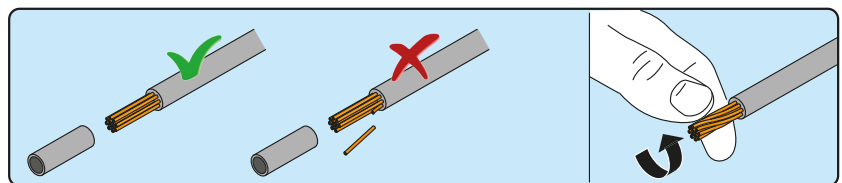
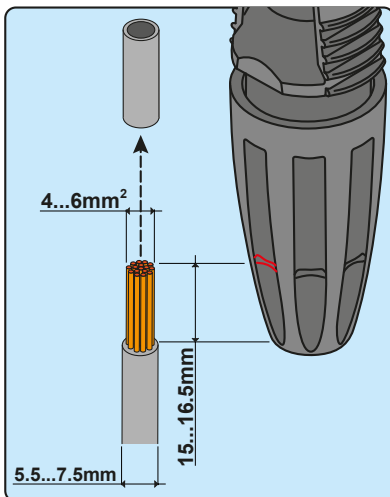

- Insert the wire into the connector until you hear a locking "click".

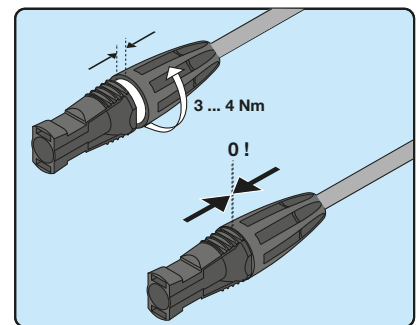
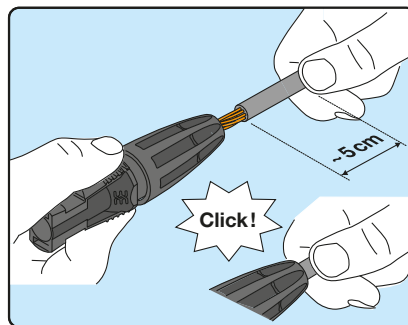

- Tighten the knurled ring nut for optimal clamping.

2. WEIDMÜLLER WM4 quick-fit connectors

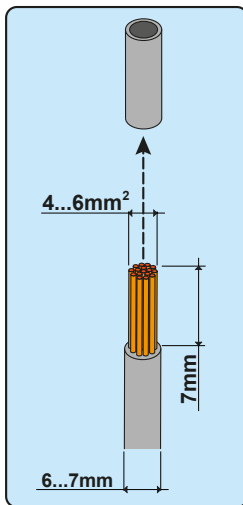

Installation of Weidmüller WM4 connectors requires crimping to be carried out with suitable equipment.

- Strip the cable to which you want to apply the connector (after verifying that it complies with the connector limits).

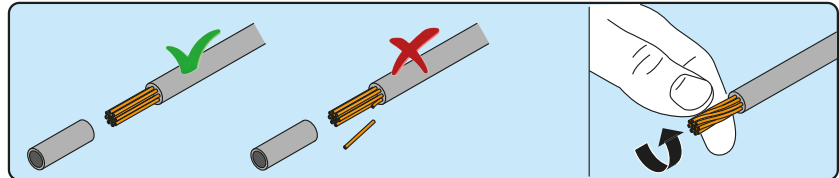

- Apply the terminal to the conductor using the designated pliers.

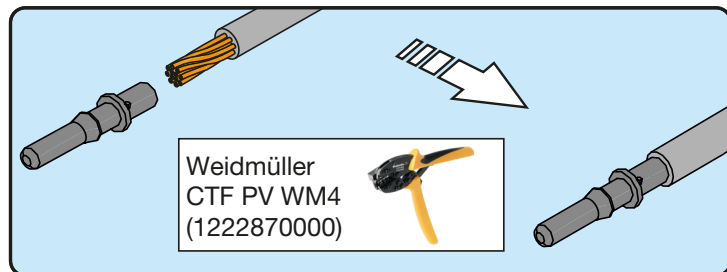

- Insert the cable with the terminal into the interior of the connector, until you hear the click indicating that the terminal is locked inside the connector.

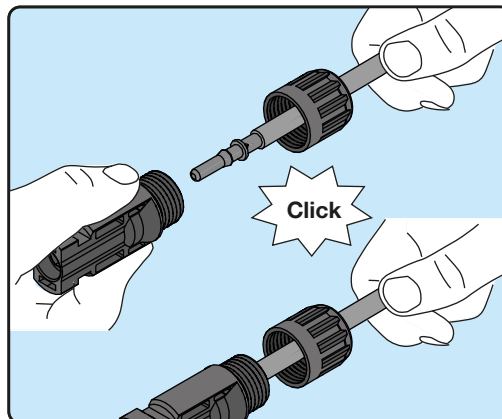

- Firmly tighten the cable gland using the relevant tool to finish the operation.

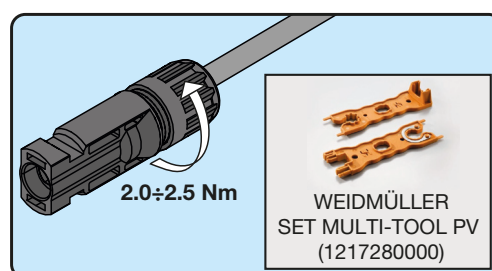

3. MULTICONTACT MC4 quick-fit connectors

Installation of Multicontact MC4 connectors requires crimping to be carried out with suitable equipment.

- Strip the cable to which you want to apply the connector (after verifying that it complies with the connector limits).

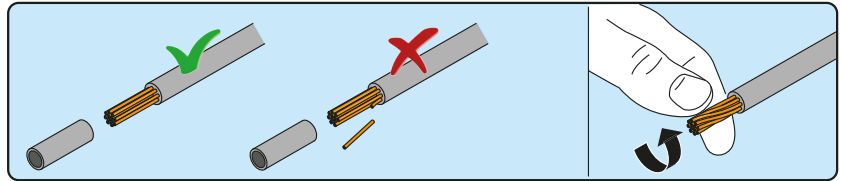
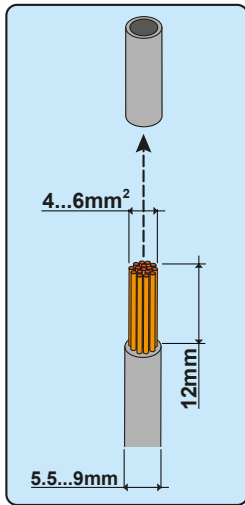

- Apply the terminal to the conductor using the designated pliers.

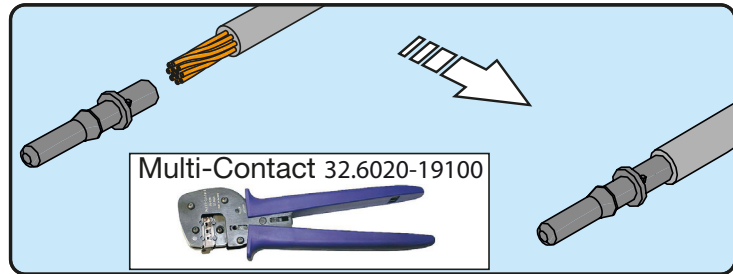

- Insert the cable with the terminal into the interior of the connector, until you hear the click indicating that the terminal is locked inside the connector.

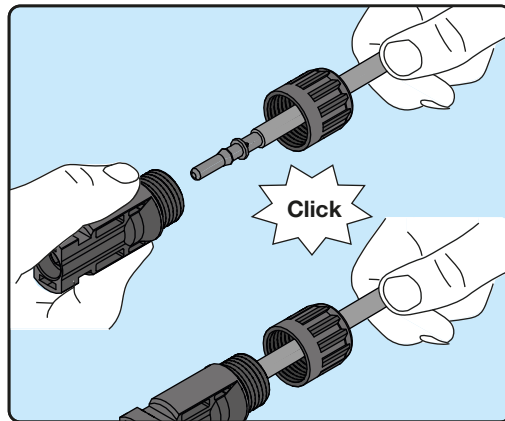

- Firmly tighten the cable gland using the relevant tool to finish the operation.

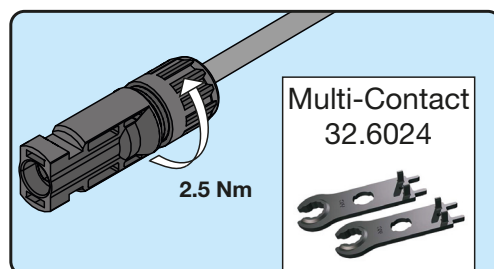

4. AMPHENOL H4 quick-fit connectors

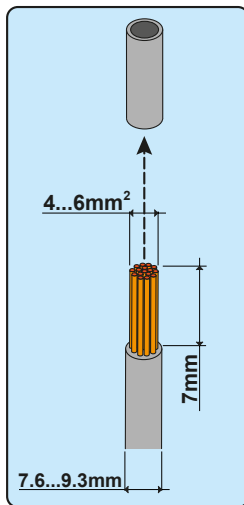

Installation of Amphenol H4 connectors requires crimping to be carried out with suitable equipment.

- Strip the cable to which you want to apply the connector (after verifying that it complies with the connector limits).

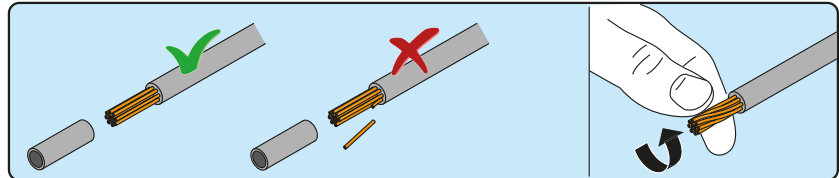

- Apply the terminal to the conductor using the designated pliers.

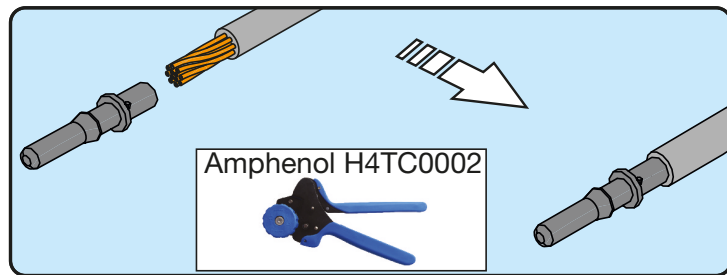

- Insert the cable with the terminal into the interior of the connector, until you hear the click indicating that the terminal is locked inside the connector.

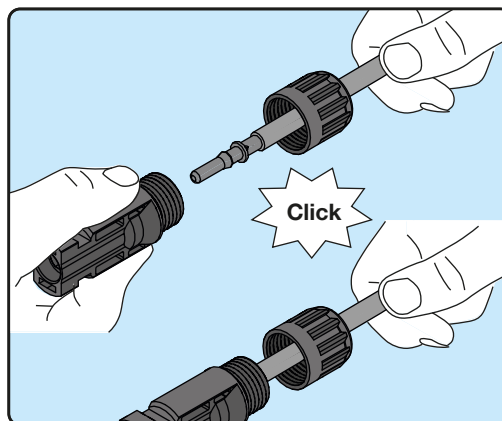

- Firmly tighten the cable gland using the relevant tool to finish the operation.

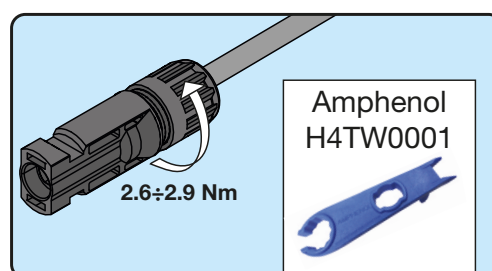

String protection fuses (-SX / -SX2 models only)

Sizing of fuses

The correct sizing of the positive side (+) ³⁵ and negative side (-) ³⁴ string fuses to be used to protect from “return currents” is very important because it can considerably limit the risk of fire and damage to the PV generator.

The wiring box equipped with string fuses are:

-SX version. Only positive side (+) ³⁵ string fuses

-SX2 version. Positive side (+) ³⁵ and negative side (-) ³⁴ string fuses

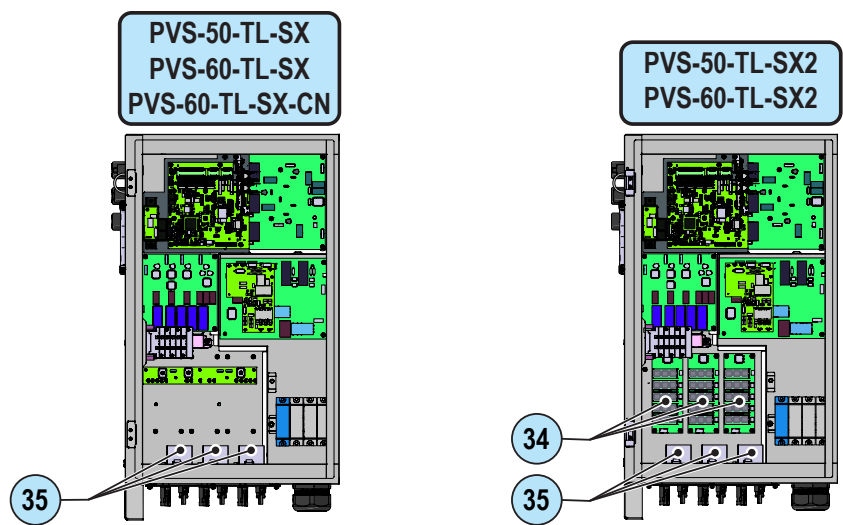

A “return current” can be generated in the event of a fault and relevant short-circuit at the ends of one or more PV modules of the system; this condition can cause all the current supplied by the strings not involved in the fault, but connected to the same input channel, to pass through the faulty string.

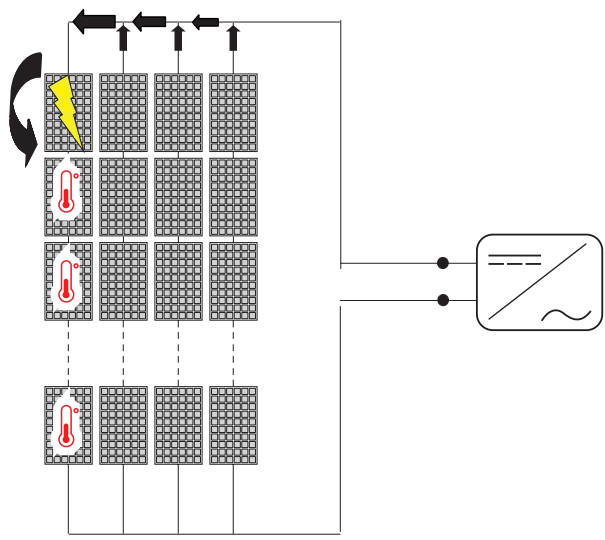

In these versions, you must directly connect the individual strings coming into the inverter (do not make field switchboards for parallel strings). This is because the positive side (+) ⁽³⁵⁾ and negative side (-) ⁽³⁴⁾ string fuses, situated on each input, are not rated to take strings in parallel (array). This operation can cause damage to the fuse and consequently malfunctioning of the inverter.

The sizing of the string fuses must be made taking into account the 2 following conditions:

1. The nominal current of the fuse (I_{rated}) must not exceed the maximum rating of the fuse to be used in series on the strings (maximum series fuse rating), indicated in the technical data of the PV modules in compliance with standard EC 61730-2:

$$I_{rated} < \text{Maximum series fuse rating}$$

2. The fuse rating (I_{rated}) must be determined based on the string current and on the sizing guidelines provided by the manufacturer to avoid untimely tripping. As a general guideline, based on the photovoltaic modules' short circuit current (I_{sc}), it is possible to calculate the rating of the fuse with the following formula:

$$I_{rated} > (1.4 \approx 1.5) * I_{sc}$$

Fuses must be chosen among the standard commercially available ratings, selecting the value that is closest to the obtained result.

The fuse selected with the calculation described previously takes into consideration derating factors and corrections such as:

- increase in the effective irradiation of the installation area
- Increase in the I_{sc} on the basis of the high temperature of the PV module
- Thermal derating of the fuse
- Maximum return current of the PV modules installed

ABB can supply fuse kit:

Code	Description	Quantity
KIT 10 FUSES 15A	Kit of 15A fuses	10

For effective calculation taking real installation conditions into account, refer to the documents supplied by the protection fuse manufacturer.



Communication and control board

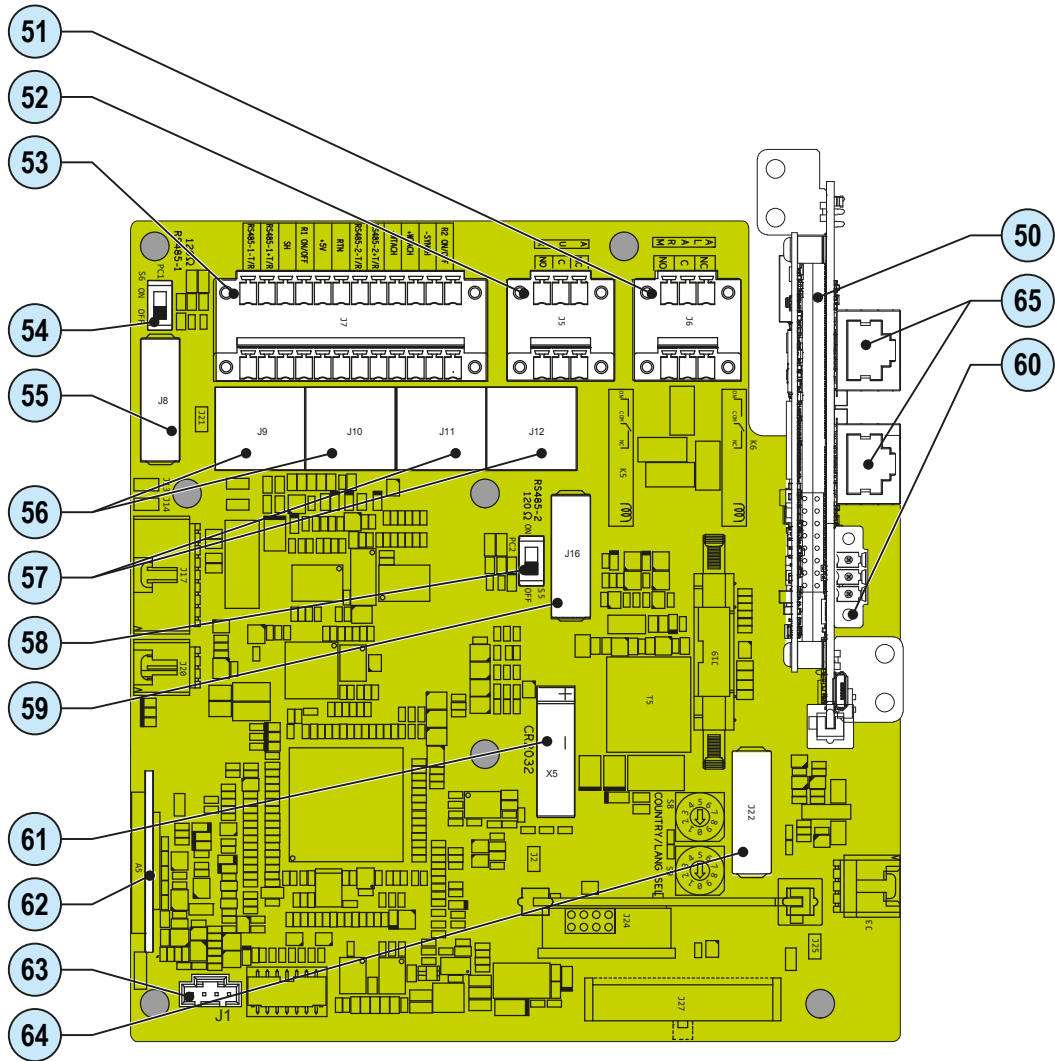

Silkscreen	Reference	Symbol
	50	Interposer board
J6	51	ALARM (multifunction relay) terminal block
J5	52	AUX (multifunction relay) terminal block
J7	53	RS485-1 and RS485-2 lines, R1 ON/OFF and R2 ON/OFF (remote ON/OFF) and 5V auxiliary lines terminal block
S6	54	RS485-1 line 120Ohm termination resistor switch
J8	55	RS485-1 communication card housing
J9, J10	56	RS485-1 line connection on RJ45 connector
J11, J12	57	RS485-2 line connection on RJ45 connector
S5	58	RS485-2 line 120Ohm termination resistor switch
J16	59	RS485-2 communication card housing
J5 on interposer board 50	60	RS485-MAIN terminal block
X5	61	Battery housing
A5	62	SD card housing
J1	63	Grounding kit connector (optional kit)
J22	64	Inverter data memory card housing
	65	Ethernet connector

Connections to the communication and control board

The communication and control signals are connected to the communication and control board inside the wiring box. In particular, on the left side of the DC wiring box, there are:

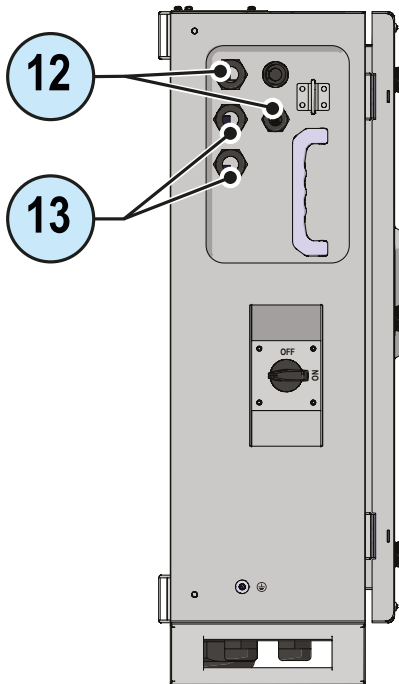

- 2 ethernet cable glands ¹² (one PG21 and one PG16). The two cable glands can be used for the daisy-chain connection (in / out) of inverters present on the system. The ethernet connection can be used to monitor, configure, and update the firmware remotely and is made on the dedicated connectors on the interposer board ⁵⁰.

- 2 cable glands ¹³ (PG21) that can be used to reach the terminals / connectors on the communication and control board. Each cable gland accepts a cable (from 13 mm to 18 mm diameter).

As an alternative to each cable gland, the two-hole gasket (supplied) can be installed, which accepts two cables with a diameter of 1.5 to 6mm; if a seal hole is not to be used, it is necessary to install a plug (supplied plastic cylinder) to ensure the inverter's sealing.

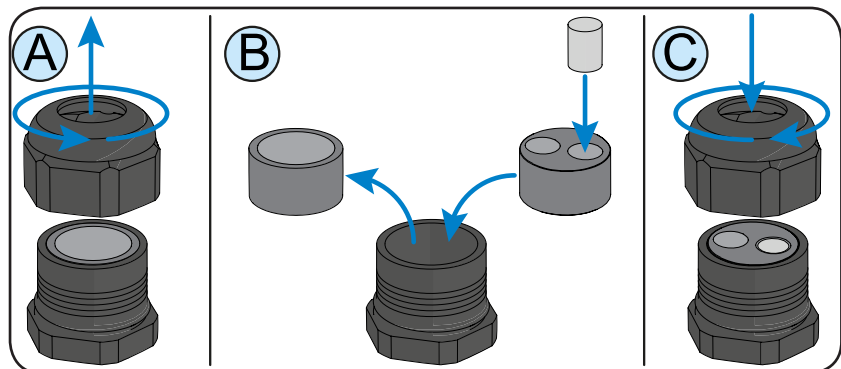

Ethernet connection

The ethernet connection allows a direct data transfer to the ABB server for monitoring purpose.

When the inverter will be powered on, network parameters are automatically set and the inverter start transmitting telemetry data to the Aurora Vision® CLOUD platform.

The connection of the ethernet communication cable must be made on the specific connectors 65 located on the interposer board 50 (vertically positioned on the communication and control board 35) inside the wiring box. If the inverters of the plant need to be connected in daisy chain or ring configuration use both connectors.

The cable should be compliant to the following specification:

- Cable type: Patch or Cross type, 100BaseTx, CAT5e (or higher) with shielding STP or FTP.
- UV-resistant if used outdoors
- Type of plug: metallic shielded RJ45
- The maximum length that can reach these cables is 100 meters, and it is always advisable not to let them pass by the power cords to avoid interference with data transmission.
- Maximum inverters number connected over one single daisy chain is 40



In order to avoid ground loop (that could create communication issues) the shield of any Ethernet cable must be connected to the RJ45 plug in only one side, the other side of the shield should be leaved floating. This could be guaranteed by crimping the shield or the screen of the ethernet cable to the RJ45 connectors only at one end of each cables.

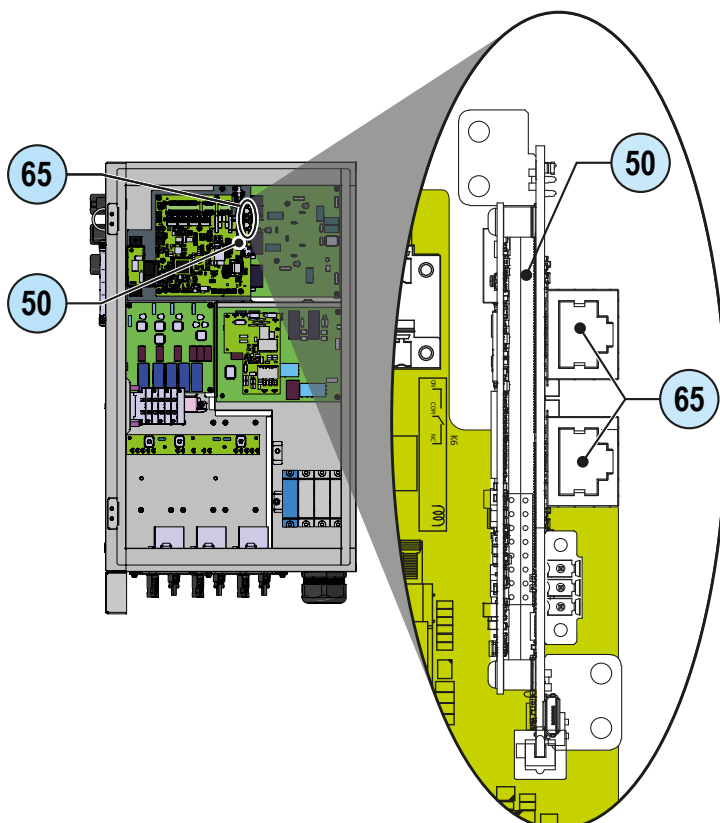

Connection of ethernet cable is made trough the two RJ45 connectors 65.

The two RJ45 connectors are equivalent to each other and can be used interchangeably for the input or for the output of the line in realising the connection of the inverters.



Three topologies of ethernet connection to the router are available:

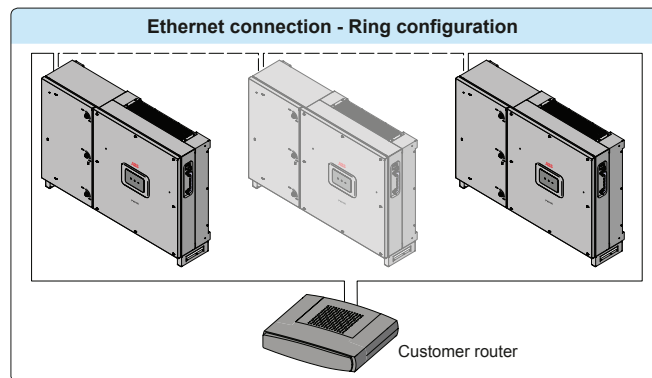

The ring configuration is the preferable way to connect the units in order to allow reaching inverters in case of single inverter fault.



In case inverters are connected to the networking switch with a ring topology is recommended to enable SPT protocol on the switch (Spanning Tree Protocol SPT (IEEE 802.1D) is enabled by default on inverters).

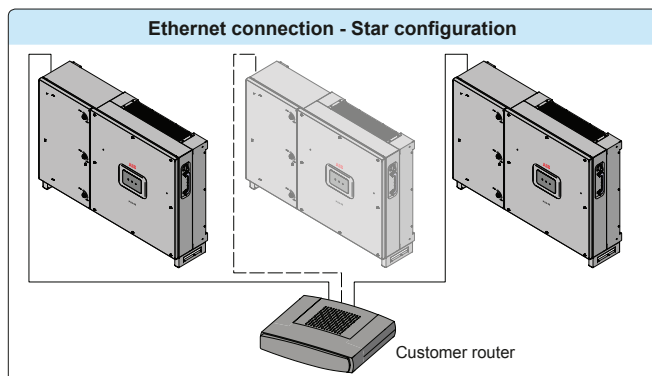
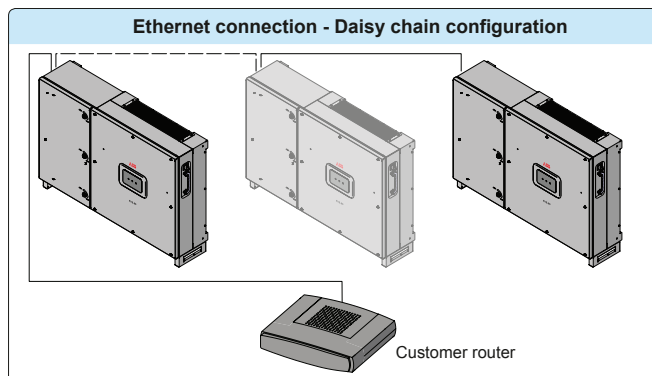

On each configuration of connection the maximum length of the cable must be 100m maximum between inverter – inverter and inverter – switch.



For further information on the Ethernet connection refer to the Local Area Network standard IEEE802.3

Please refer to Aurora Vision documents available on ABB website for further information how to get an Aurora Vision account for remotely monitoring and managing the installed solar assets.



No initial setup is required to start data transmission to Aurora Vision.
Internet connection is required to use all the Aurora Vision remote functionalities.

Serial Communication connection - Slave (RS485-1, RS485-2)



Be advise that automatic settings of network parameters at the turning on, embedded logging capability, automatic logger free transferring of data to Aurora Vision Cloud and remote firmware update are provided over TCP/IP (Ethernet and/or Wi-fi) bus only.



The use of the inverters over the RS485 line is recommended in case of monitoring and controlling by using third party RS485 control systems.
The connection of the inverters over this RS485 line is recommended for replacement of already installed old model of inverters or service purpose only.

- RS485-1 serial communication line.

The communication protocol can be set as "Aurora" (proprietary communication protocol) or Modbus RTU (ABB protocol).

This port must be used for firmware upgrading (locally or remotely through the ABB monitoring devices)



When connecting the ABB monitoring devices, the RS485-1 line must be used

- RS485-2 serial communication line.

The communication protocol can be set as "Aurora" (proprietary communication protocol), Modbus RTU (ABB protocol) or Modbus RTU (Sunspec protocol).



Cables connecting the RS485 line may use two different types of connection:

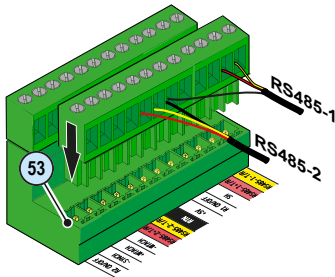

• Connection of the conductors using the terminal connectors ⁵³

For long distance connections, the connection on terminal connector is preferable using a shielded twisted pair cable with characteristic impedance of $Z_0=120$ Ohm like the one shown on the following table:

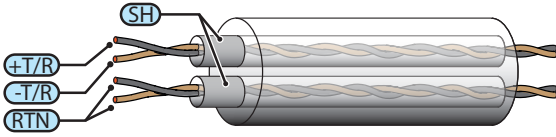
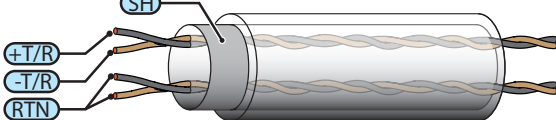
	Signal	Symbol
	Positive data	RS485 (-1 or -2) +T/R
	Negative data	RS485 (-1 or -2) -T/R
	Reference	RTN
	Screen	SH



Shield continuity must be provided along the communication line using the SH terminal and must be grounded at a single point.

The RS485 line can be used to set up a line of communication which, when connected to a monitoring device, enables the operation of the photovoltaic system to be kept under control. Depending on the device used monitoring can be local or remote.



For information on installation, compatibility and use please refer to the specific documentation on the accessory components.

- **Connection of conductors with RJ45 connectors ⑤⑥ or ⑤⑦**
The two RJ45 connectors (A) and (B) available for the RS485 communication, are equivalent to each other and can be used interchangeably for the arrival or for the output of the line in realising the daisy chain connection of the inverters.

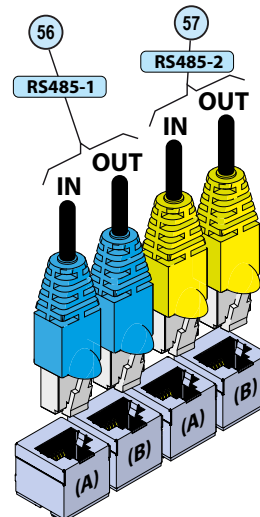

Table: crimping diagram for RJ45 connectors

	Pin No.	Function
	3	+T/R
	5	-T/R
	7	RTN
	1, 2, 4, 6, 8	not used



Use a connector with metal body to provide cable shield continuity!

For both type of connection, proceed to connect all the units of the RS485 chain in accordance with the daisy-chain model observing the correspondence between the signals, and activate the termination resistance of the communication line in the final element of the chain by switching:

- the 54 switch for the RS485-1 line in the ON position.
- the 58 switch for the RS485-2 line in the ON position.

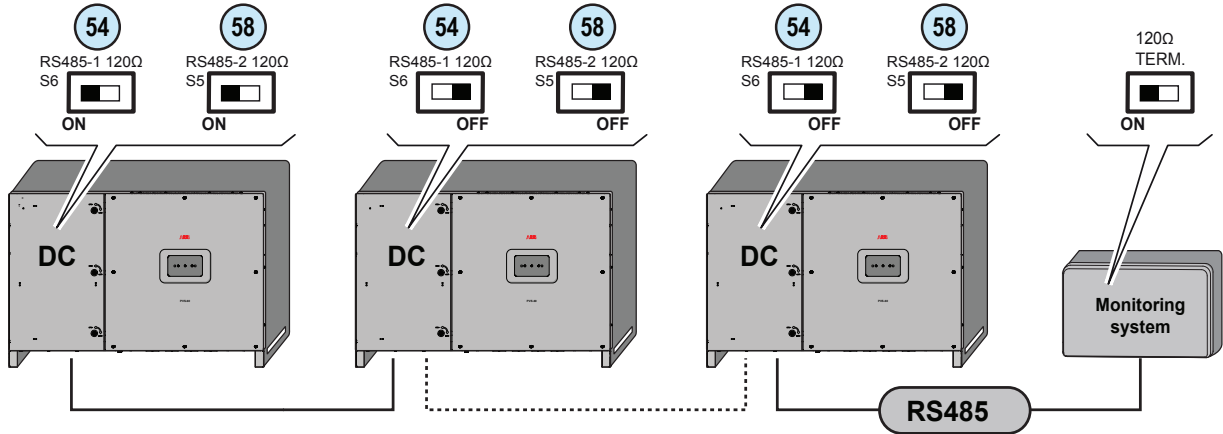

The communication line must also be terminated on the first element of the chain which normally corresponds to the monitoring device.



It is recommended not to exceed a length of 1000m for the communication line. The maximum number of inverters that can be connected to the same RS485 line is 62.

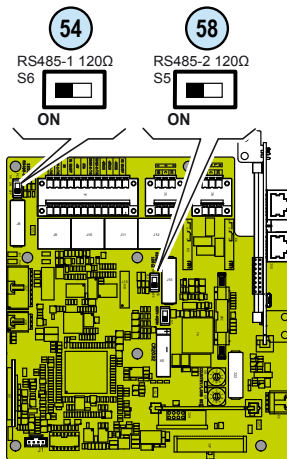

When connecting a single inverter to the monitoring system, activate the communication line resistance terminal by setting the switch 54 or 58 (to the ON position).

Set a different RS485 address on each inverter in the chain. **No inverter can have "Auto" as an address.** An address can be freely chosen between 2 and 63.

The setting of the address on the inverter is done through the "Aurora Manager" software.

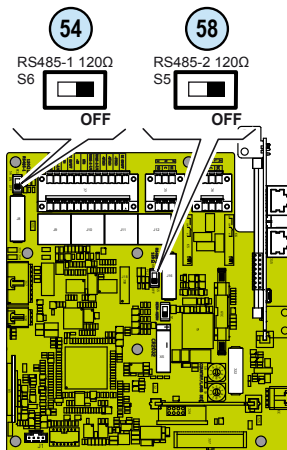

When an RS-485 connection is being used, if one or more inverters are added to the system at a later time, it is necessary to remember to reset to OFF the switch on the termination resistance being used (1) or (2) on the inverter which previously was the last in the system.

Each inverter is shipped with the RS485 address pre-set to two (2) and with the resistance terminal setting switch 54 or 58 in the OFF position.

Serial Communication connection - Slave/Master (RS485-MAIN)

The RS485-MAIN terminal block (60) is located on the Interposer board (50).

This port can be setted as:

- **Slave** (default setting). In this configuration the port allows to connect one device using Modbus RTU (ABB protocol) or Modbus RTU (Sunspec protocol) communication protocol.



Is possible to connect only one device to the RS485-MAIN

- **Master**. In this configuration the port is used for connecting supported accessories (like energy meter, VSN800 weather station, etc); in this case data from accessories will be logged and transferred to the cloud by inverter itself (master mode). To know how to connect the accessories to the RS485 terminal block refer to accessory product manual or contact ABB customer support. When an accessory is connected to the RS485-MAIN port it must be added and configured into the “Device Acquisition” list on the integrated Web User Interface (refer to chapter “Web User Interface”).

In both the configurations the connection to the RS485-MAIN is made on the dedicated connector located on the Interposer board (50).

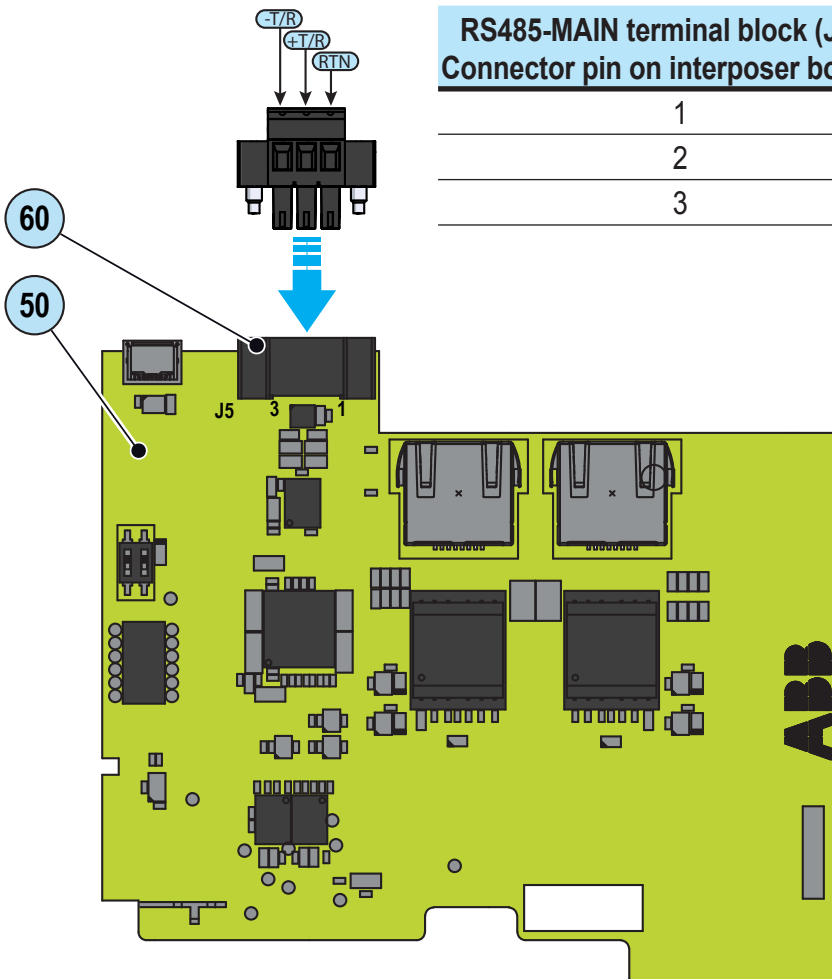

RS485-MAIN terminal block (J5) (60) Connector pin on interposer board (50)	RS485 signal
1	RTN
2	+T/R
3	-T/R

Remote control connection

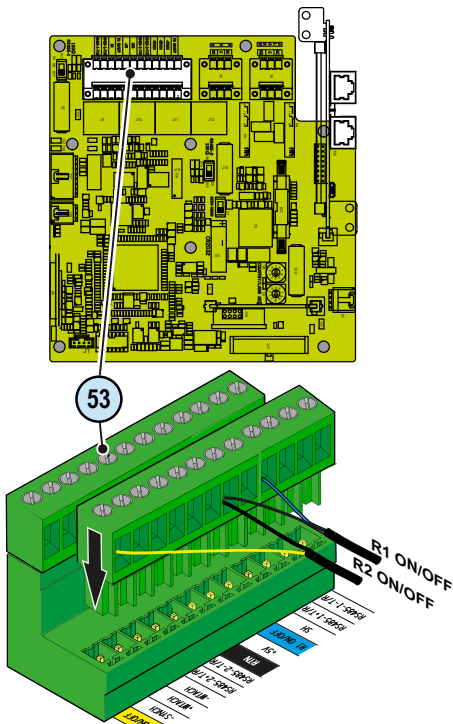

The connection and disconnection of the inverter to and from the grid can be controlled through an external control.

The function must be enabled in the relevant menu through the Aurora Manager Tools software. If the remote control function is disabled, the switching on of the inverter is dictated by the presence of the normal parameters which allow the inverter to connect to the grid.

If the remote control function is operating, besides being dictated by the presence of the normal parameters that allow the inverter to connect to the grid, the switching on of the inverter also depends on the state of the R1 ON/OFF and R2 ON/OFF terminals compared to the RTN terminal present on the [a11](#) connector of the communication and control board [35](#).

When one of the R1 ON/OFF or R2 ON/OFF signals is brought to the same potential as the RTN signal (i.e. by making a short circuit between the two terminals of the connector), this causes the inverter to disconnect from the grid.

The connections of these controls are made between the "R1 ON/OFF" and the "R1 ON/OFF" inputs compared to the common "RTN" signal. Since this is a digital input, there are no requirements to be observed as regards cable cross-section (it only needs to comply with the sizing requirement for passing cables through the cable glands and the terminal connector).



Configurable Relay connection (ALARM and AUX)

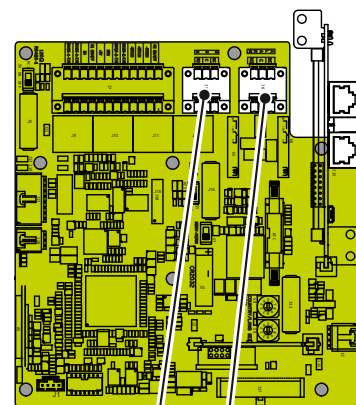

The inverter is equipped with 2 multifunction relays with configurable activation. It can be connected with normally open contact (being connected between the NO terminal and the common contact C) and with normally closed contact (being connected between the NC terminal and the common contact C).

Different types of devices (light, sound, etc.) can be connected to the relay, provided they comply with the following requirements:

Alternating current

Maximum Voltage: 240 V AC

Maximum Current: 1 A

Direct current

Maximum Voltage: 30 V DC

Maximum Current: 0.8 A

Cable requirements

External diameter: from 5 to 17 mm

Conductor cross-section: from 0.14 to 1.5 mm²

This contact can be used in different operating configurations that can be selected by accessing the embedded web server.

Front cover closure

After terminating the connection and configuration of the inverter and before commissioning, the inverter's front cover must be closed.

IP65

It is necessary to ensure the correct closing of the cover to maintain the IP protection degree of the inverter

- Carefully close the cover.
- Insert the key in the key lock ⑧
- Turn the key lock ⑧ in "LOCK"
- Repeat the operation for the other key lock ⑧

Commissioning of the inverter can be started once the cover have been closed

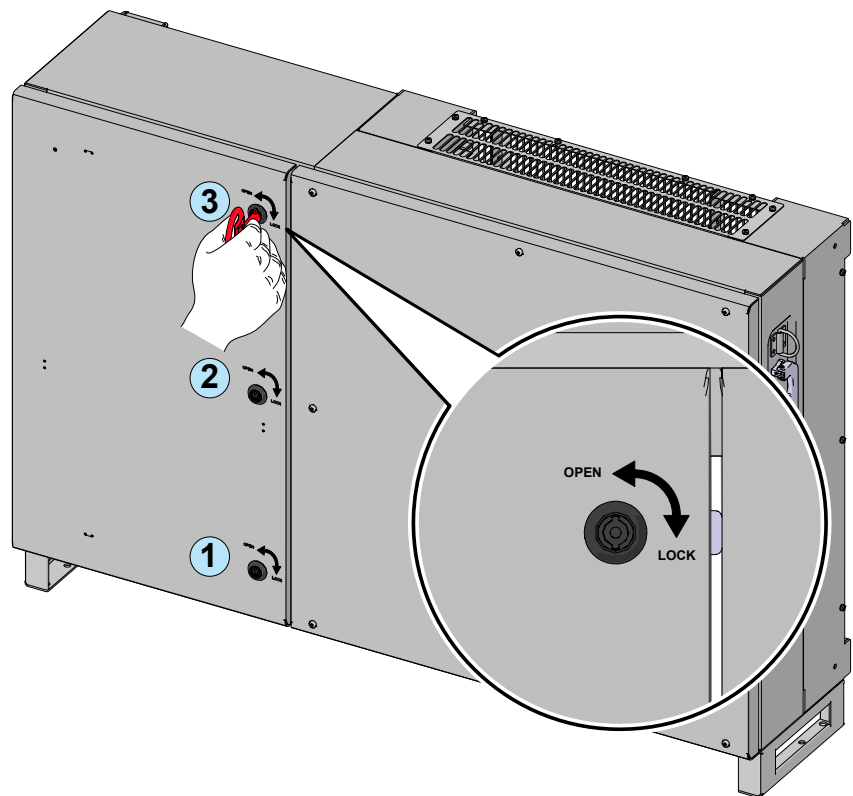

General conditions

One of the first rules for preventing damage to the equipment and to the operator is to have a thorough knowledge of the instruments. We, therefore, advise that you carefully read this manual. If you are not sure about any information in this manual, please ask ABB Service for more detailed information.



Do not use the equipment if:

- you do not have suitable qualifications to work on this equipment or similar products;*
- you are unable to understand how it works;*
- you are not sure what will happen when the buttons or switches are operated;*
- you notice any operating anomalies;*
- there are doubts or contradictions between your experience, the manual and/or other operators.*

ABB cannot be held responsible for damage to the equipment or the operator if it is the result of lack of knowledge, insufficient qualifications or lack of training.

Description of the LED function

The LED functions on the inverter are described below.

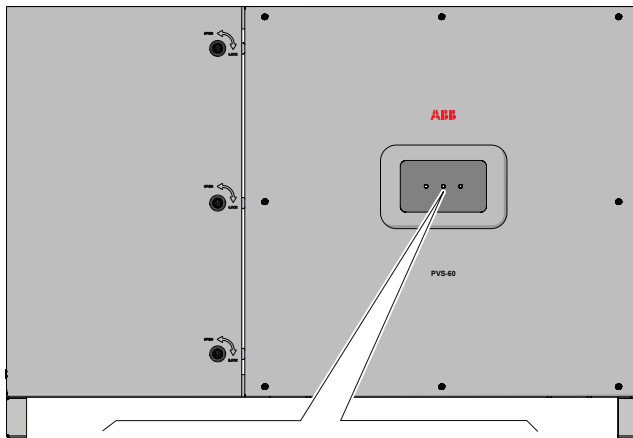

GREEN

Indicates that the inverter is functioning correctly.

When the unit is commissioned, while the grid is checked, this LED blinks. If a valid grid voltage is detected, the LED remains continuously lit, as long as there is sufficient sunlight to activate the unit. Otherwise, the LED will continue to blink until the sunlight is sufficient for activation.

YELLOW

Indicates that the inverter has detected an anomaly. This type of problem is highlighted through the "Aurora Manager Lite" software.

RED

The "GFI" (ground fault) LED indicates that the inverter has detected a ground fault in the DC side photovoltaic generator. When this fault is detected, the inverter immediately disconnects from the grid.

The LEDs, in various multiple available combinations, can signal multiple conditions other than the original single condition; see the various descriptions explained in the manual.

LED isolation fault

Interventions after warning of isolation fault

When the red LED activates, first of all try to reset the alarm using the the embedded web server.

If the inverter reconnects normally to the network the fault was due to temporary phenomena.

You are advised to have the plant inspected by the installer or a specialist should this malfunction occur repeatedly.

If the inverter does not reconnect to the grid, isolate it on both the AC and DC sides (by using the disconnect switches), then contact the installer or authorised centre to repair the fault in the photovoltaic generator.

User interface

1. Embedded Web User Interface

- Accessible via Wi-Fi by using any WLAN enabled standard device (PC, smartphone, tablet,....)
- Enables single inverter parameters settings (Aurora Manager Embedded)
- Updating of the inverter firmware.

2. Local display

- Just for reading settings
- Enabled setting RS485 ports addresses and MPPT functioning mode
- Available on request (it is an accessory)

3. Aurora Manager Lite

- Mainly for service purpose
- Local monitoring of the inverter.
- Advanced configuration of the inverter (INSTALLER access level)
- Updating of the inverter firmware.
- In order to use the software a connection must be established between the PC and the inverter (by means of an RS485 communication line) using a PVI-USB-RS485_232 signal converter.



4. Mobile app and web portal Aurora Vision

- Remote monitoring of the inverter.

Measurement tolerance

The data supplied by the inverter may differ from measurements taken by certified measuring instruments (e.g. output meters, multimeters and grid analysers); since the inverter is not a measuring instrument it has wider tolerances for the measurements it makes.

The tolerances are generally:

$\pm 5\%$ for real-time measurements with output power below 20%

$\pm 3\%$ for real-time measurements with output power above 20%

$\pm 4\%$ for all statistical data.



General conditions

Before checking the operation of the equipment, it is necessary to have a thorough knowledge of the Instruments chapter 6 and the functions that have been enabled in the installation process.

The equipment operates automatically without the aid of an operator; the operating state should be controlled through the equipment's instrumentation.

The interpretation or variation of some data is reserved exclusively for specialized and qualified staff.



*The incoming voltage must not exceed the maximum values shown in the technical data, section 2 in order to avoid damaging the equipment.
Consult the technical data for further details.*

During operation, check that the environmental and logistical conditions are correct (see installation chapter 5).

Make sure that environmental and logistical conditions have not changed over time and that the equipment is not exposed to adverse weather conditions.

Commissioning



Do not place objects of any kind on the inverter during operation! Do not touch the heat sink while the inverter is operating! Some parts may be very hot and could cause burns.



Before proceeding with commissioning, make sure you have carried out all the checks and verifications indicated in the section on preliminary checks.



Make sure irradiation is stable and adequate for the inverter commissioning procedure to be completed.

Commissioning could be carried out in two different ways:

- **Via ABB Installer for Solar Inverters APP**

Recommended mobile APP for commissioning single inverter as well as multi inverter solar plant.

- **Via Web UI (access point wireless network)**

Integrated Web User Interface enabling setting parameters and performing commissioning of a single inverter (multi inverter support is not provided).

Recommended as alternative method for performing single inverter commissioning.



Commissioning via Installer for Solar Inverters mobile APP

“Installer for Solar Inverters” is the new advanced ABB mobile APP allows to simplify commissioning, parameter settings and troubleshooting of ABB string multi-inverters in large scale solar plants.

Even in case of single inverter installation it can be consider the most suitable professional tool to be used.

“Installer for Solar Inverters” mobile APP is available for mobile devices with an Android version of 6.0.1 or greather (iOS mobile devices support will come soon) and could be downloaded and installed from Play Store.

Commissioning procedure:

It's higly recommended to connect the inverters in ethernet daisy chain (with or without ring) before executing the commissioning procedure.

Make sure that all the inverter being commissioned features the last firmware version (updating can be executed via Installer for Solar Inverters mobile APP).

- Close the DC disconnect switches  to supply the inverter with input voltage from the photovoltaic generator.



Make sure irradiation is stable and adequate for the inverter commissioning procedure to be completed.

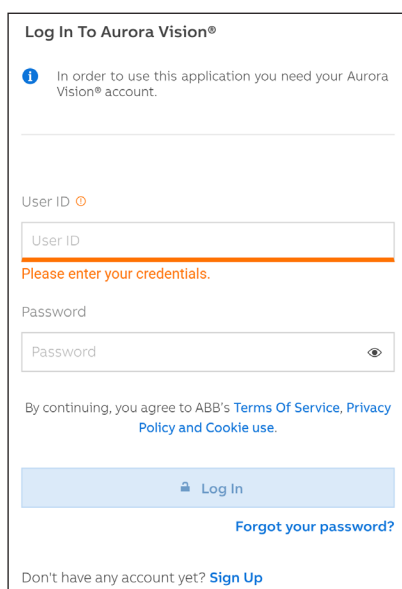

Log In To Aurora Vision®

i In order to use this application you need your Aurora Vision® account.

User ID 

User ID

Please enter your credentials.

Password

Password 

By continuing, you agree to ABB's [Terms Of Service, Privacy Policy and Cookie use](#).

 Log In

[Forgot your password?](#)

Don't have any account yet? [Sign Up](#)

The main steps to complete the commissioning procedures are listed below:

- Installer for Solar Inverters mobile APP installed on mobile device.
 - Enabled Aurora Vision installer account allowed to use the mobile APP
- The account can be created in the mobile APP directly following the dedicated wizard procedure.

- Manual claiming of the inverters to be commissioned.

The claiming process consists of indicating which inverters are to be commissioned.

Claiming process can be executed by scanning the QR codes of all the inverters being worked and putting the selected inverters into the working list. Please insert in the list inverters belonging to the same inverters family; no more than 40 inverters by time can be configured together.

As an alternative of QR code scanning, claiming process can be executed by selecting manually the SSIDs associated to the Wi-Fi networks generated by each inverter to commission and inserting Product key when requested.

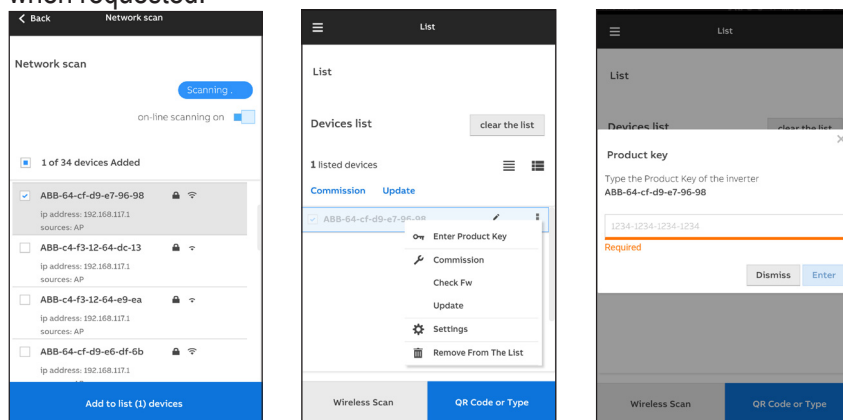

Both QR code and Product key are provided on the Communication identification label stuck onto each inverter.



The Communication Identification label is divided in two separate parts by a dashed line; take the bottom part and apply it on the plant documentation. (it's recommend to create a plant map and apply the Communication Identification label of each inverters in the right position of that map).

Above steps are valid for executing any available functionalities of the Installer for Solar Inverters mobile APP.

- In order to launch the installation wizard and so complete the commissioning procedure please click “Commissioning” button. If needed click prevently on “Firmware update” button for aligning the firmware of all the inverters in the list to the last version (internet connection is needed).
- Enter the IP Settings(DHCP or Static), Network SSID and password. Tap on “Connect” button to connect the inverter to the local wireless network. If the inverter should not be connected to a Local wireless network tap on “Skip this step” button (the inverter connection remains point-to-point).

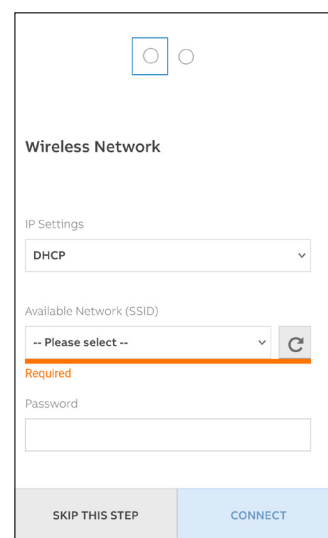
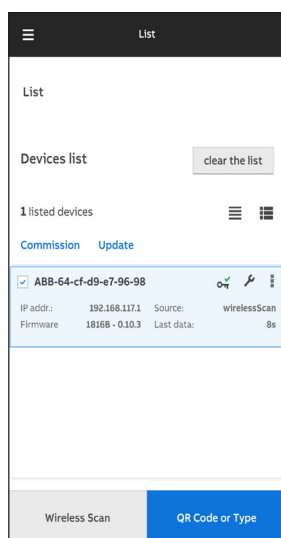

- Select the country standard and the configuration of the input channels. confirm the setting by clicking “DONE”.The image shows the successful commissioning.

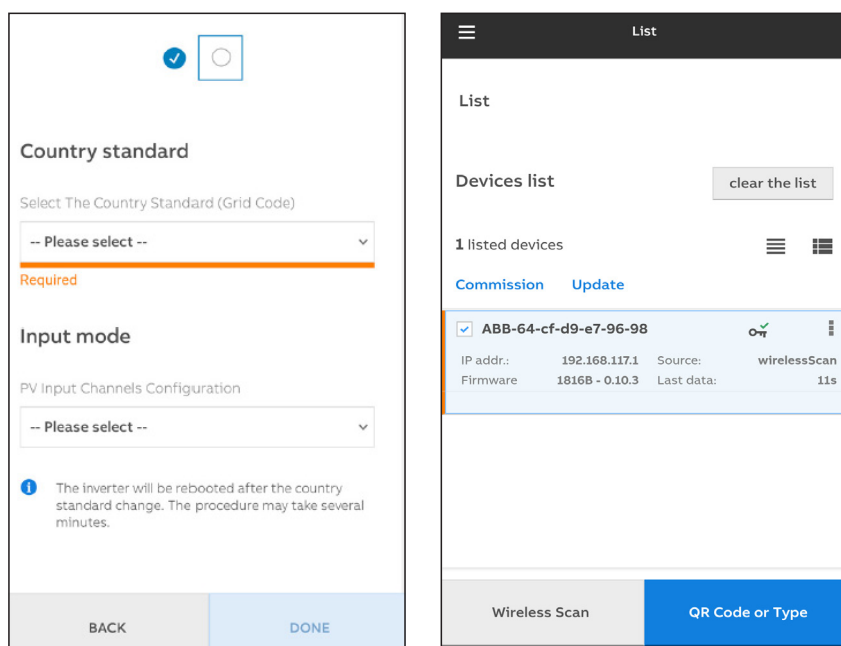

in the SETTING section it's possible to access the following sub-menus:

- RS485
- LAN
- WLAN
- Monitored Devices

RS485 (immagine 485): allows to set address, baud rate, parity mode and communication protocol.

LAN (immagine lan):it's possible to view the status and change the daisy chain configuration of the two ethernet ports of the inverter.

WLAN (immagine wlan):it's possible to view the status of the two wireless channels of the inverter, and to disconnect the channel 2.

•Monitored Devices (monitored devices + add device): it's possible to add and config the connected supported accessories to the RS485 (in this case, modify the data on the rs485 tab according to the characteristics of the inserted device)



For more details about commissioning and any other functionalities of the Installer for Solar Inverters mobile APP please contact ABB customer support.



For any other specific settings of parameters of single inverters please refer to “Description of the Web User Interface” chapter.

After the commissioning via ABB Installer for Solar Inverters APP is completed, the inverter changes the behaviour of the “Power” and “Alarm” LEDs ⁰⁸, in relation of the input voltage value:

Input voltage	LED Status	Description
$V_{in} < V_{start}$	Power = Flashing Alarm = OFF	The input voltage is not sufficient to enable connection to the grid.
$V_{in} > V_{start}$	Power = Flashing Alarm = ON	The input voltage is sufficient to enable connection to the grid: the inverter waits for the grid voltage to be present to make the connection to the grid.



The inverter is powered SOLELY by the voltage generated by the photovoltaic generator: the presence of grid voltage alone is NOT SUFFICIENT for the inverter to switch on.

- When the input voltage is sufficient to allow the connection to the grid, close the AC switch downstream of the inverter thus applying the grid voltage to the inverter: the inverter checks the grid voltage, measures the isolation resistance of the photovoltaic field with respect to ground and performs other auto-diagnostic checks. During the preliminary checks on the parallel connection with the grid, the “Power” LED keeps flashing, the “Alarm” and “GFI” LEDs are OFF.
- The inverter ONLY creates a parallel connection with the grid if the grid and isolation resistance parameters fall within the ranges foreseen by current regulations.
- If the outcome of the preliminary checks on the grid parallel is positive, the inverter connects to the grid and starts to export power to the grid. The “Power” LED remains fixed on while the “Alarm” and “GFI” LEDs are OFF.



To address any problems that may occur during the initial stages of operation of the system and to ensure the inverter remains fully functional, you are advised to check for any firmware updates in the download area of the website www.abb.com/solarinverters or at <https://registration.abb-solarinverters.com> (instructions for registering on the website and updating the firmware are given in this manual).



Commissioning Via Web UI - Wireless connection

CONNECTION TO THE INVERTER - WIRELESS

Commissioning could be carried out via wireless connection to the inverter's Web User Interface. Initial setup of the system must therefore be carried out via a tablet, notebook or smartphone with a wireless connection.

- Close the DC disconnect switches ¹⁵ to supply the inverter with input voltage from the photovoltaic generator.



Make sure irradiation is stable and adequate for the inverter commissioning procedure to be completed.

- Once powered, the inverter will automatically create a wireless network (approx. 60 seconds after its switch-on).
- Enable the wireless connection on the device which is being used for the board setup (tablet, smartphone or PC) and connect it to the Access Point created by the inverter system: the name of the wireless network created by the system that the connection should be established with, will be: **ABB-XX-XX-XX-XX-XX-XX** where "X" is a hex digit of the wireless MAC address (MAC address can be found on the "Communication Identification Label" placed on the side of the inverter).



The screens shown below pertain to a tablet with the Android operating system. Screens on other devices or operating systems may differ.



- When required digit the **PRODUCT KEY** (printed on the "Communication Identification label" and applied during the commissioning phase to the plant documentation) as access point password.

Note that it's required to digit also the dash "-" characters of the Product Key in the password field.



In case of need, product key can be recovered by Aurora Vision Cloud or by calling ABB technical support.

COMMISSIONING PROCEDURE - WIRELESS CONNECTED

- Open an internet browser (recommended browser: Chrome versions from v.55, Firefox versions from v.50, explorer is not compatible) and enter the pre-set IP address **192.168.117.1** to access the Web User Interface. Web User interface has easy commissioning wizard to commission the inverter.



The language of the wizard could be changed by clicking on the upper status bar

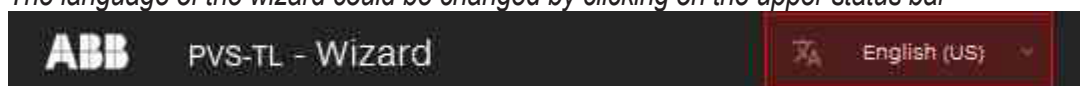

The required informations during the procedure are:

STEP 1 - Administrator/User login credentials

Administrator account

Admin ⓘ

Username

Required

Password ⓘ

Password

Required

Confirm Password ⓘ

Re-enter Password

Required

User account

User ⓘ

Username

Required

No user password

NEXT

- Set the **Administrator** account user and password (minimum 8 character for password):
Administrator account can open and view the contents of photovoltaic site. Additionally, they can make changes to inverter settings.
User and password are CASE SENSITIVE.
- Set the **User** account user and (optional) password (minimum 8 character for password):
User account can only read data. It cannot make any changes.
User and password are CASE SENSITIVE.



STEP 2 (Optional) - Wireless network connection.

As described on chapter 2 the recommended way to get all the installed inverters to communicate to the internet and Aurora Vision Cloud is creating a cabled Ethernet daisy chain bus. Anyway, in case of a few inverters installation in suitable environment, it is also possible to connect each inverter of the plant to a Wi-Fi router without using any cable.

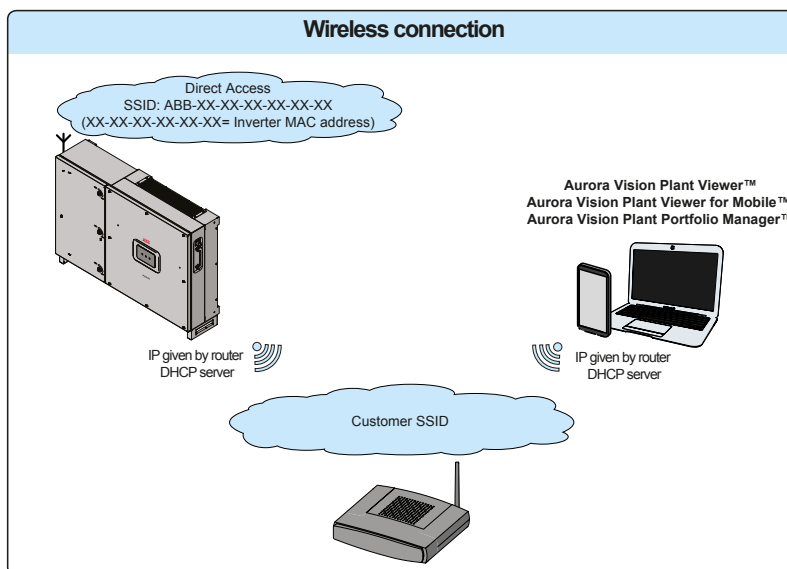

The AP is still available and the user can connect to the inverter.

In this scenario the Router gives IPs according to its own rules.

Inverter is reachable by IP.

Domain name can be used only if the Router permits multicast

During the installation wizard of the single inverter, the installer will be asked to connect the inverter to a Wi-Fi router. By selecting connection to Wi-Fi router the inverter will turn on a second Wi-Fi radio channel in order to enable connection to the Wi-Fi router. By selecting “Skip this step” button the other radio channel will be kept off.

Two Wi-Fi radio channels enables simultaneous wireless connection; one static IP address connection between inverter and installer devices and one between inverter and switch/router.

Whatever means is used to connect the inverter to the router (Ethernet cable or Wi-Fi) it will be always possible to access to the embedded web server also by connecting its own device to the same switch/router, and reaching the inverter (via second radio channel in case of Wi-Fi connection with the router) by using the assigned IP address or inverter’s host name



The IP address assigned to the inverter may vary or may be unknown. Please contact the IT administrator for getting the assigned IP address.

Differently from the assigned IP address, the «Host Name» of the inverter is unchangeable over time.

In order to use the «Host Name» as an alternative to the assigned IP address, for accessing to the inverters web server from the router the Domain Name System (DNS) service is needed to be available and activated.



The Host Name associated to each ABB inverters is structured as indicated below:

ABB-logger ID.LOCAL where:

logger ID stands for the MAC address indicated on the “Communication identification lable” applied on the inverter.

The parameters relating to the customer wireless network (set on the router) that must be known and set during this step are:

- IP Settings: DHCP or Static.

If you select the DHCP function (default setup) the router will automatically assign a dynamic IP address to the inverter whenever it tries to connect to the user network.

With Static, the user can assign a fixed IP address to the system. The data which has to be entered in order for IP static address assigning to take place will appear. Complete the additional fields at the bottom of the screen (all the fields are mandatory with the exception of the secondary DNS server).

- Available networks (SSID):

Identify and select your own (customer) wireless network from all those shown in the SSID field (you can carry out a new search of the networks that can be detected with the Update button ).

Once the network has been selected, confirm.

- Password: Wireless network password.

Enter the password for the destination network (if necessary) and start the connection attempt (it will take a few seconds).

Click on “Connect” button to connect the inverter to the home wireless network.



A message will ask for confirmation. Click “Next” to connect the inverter to the customer wireless network.

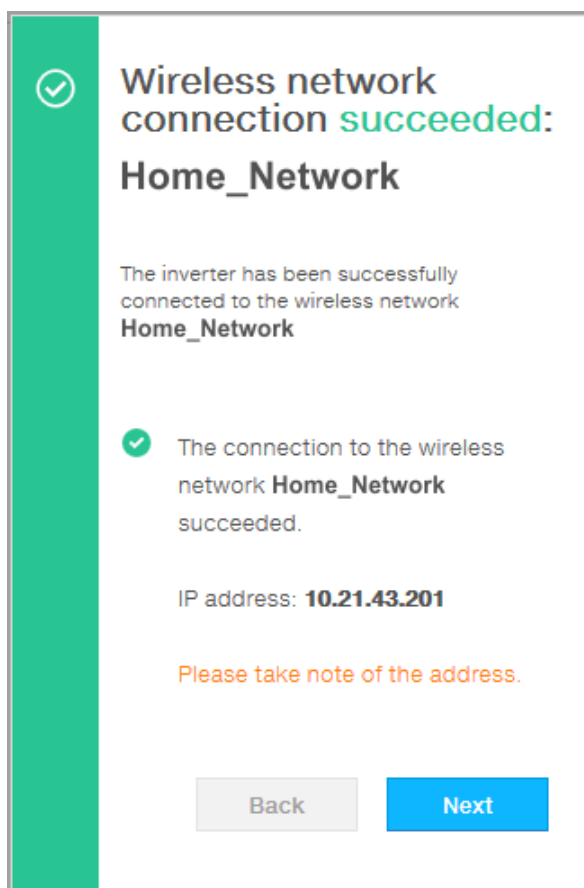

Once the inverter is connected to the customer wireless network, a new message will confirm that the connection is acquired.

The message provides the IP Address assigned by the home wireless network router to the inverter that can be used each time you want to access the Web User Interface, with the inverter connected to the home wireless network. **Take note of it.**

Click on “Next” button to proceed to the next stage of the configuration wizard.



The IP address assigned may vary for reasons connected to the wireless home router setup (for example, a very brief DHCP lease time). If verification of the address is required, it is usually possible to obtain the client list (and the corresponding IP addresses) from the wireless router administration panel.

If the inverter loses the connection with the home wireless network (and therefore, loses the internet connection), it will once again enable its own access point.



The most common causes of losing connectivity might be: different wireless network password, faulty or unreachable router, replacement of router (different SSID) without the necessary setting updates.

STEP 3 - Date, Time and Time zone

Date and Time

✔ Network Time Protocol server has been detected and it will be used to keep the system clock synchronized.

Date ●

Feb 22, 2017

SET by the NTP server

Time ●

3:28 PM

SET by the NTP server

Time Zone

Europe/Berlin GMT+01:00

BACK NEXT

Set the Date, Time and Time zone (The inverter will propose these fields when available).

Date and Time

⊙ Network Time Protocol server has not been detected. Clock isn't synchronized. The displayed date and time come from the inverter or have been manually set up.

Please set the correct system date and time if needed.

Date and time will be automatically updated as soon as an NTP server is available.

Date

2/8/17

Time

11 : 56 AM

Time Zone

Europe/Berlin GMT+01:00

BACK NEXT

When it's not possible for the inverter to detect the time protocol, these fields have to be manually entered.

Click on "Next" button to proceed to the next stage of the configuration wizard.

STEP 4 - Inverter country standard and Input configuration

- **Country standard: selection of grid standard:**

Set the grid standard of the country in which the inverter is installed.



From the moment that the grid standard is set, you have 24 hours to make any changes to the value, after which the “Country Select > Set Std.” functionality is blocked, and the remaining time will have to be reset in order to have the 24 hours of operation available again in which to select a new grid standard (follow the procedure “Resetting the remaining time for grid standard variation” described in the relevant section).

- **Input mode:**

(See the relevant section of this manual to know how set the input mode)

1. **Independent**
2. **Parallel**

Confirm the settings by clicking “END” and the inverter will reboot.

A notification will confirm that the wizard is completed.

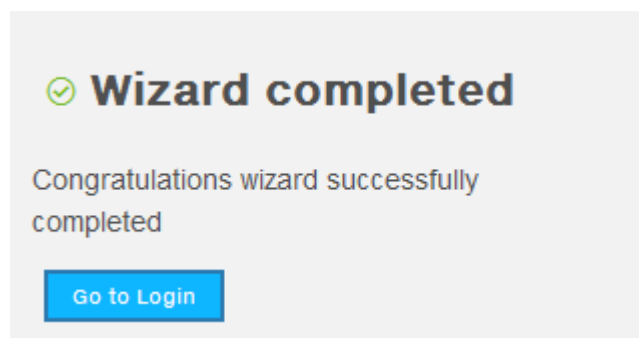

- After the wizard is completed the inverter changes the behaviour of the “Power” and “Alarm” LEDs ⁰⁵ in relation of the input voltage value:

Input voltage	LED Status	Description
$V_{in} < V_{start}$	Power = Flashing Alarm = OFF	The input voltage is not sufficient to enable connection to the grid.
$V_{in} > V_{start}$	Power = Flashing Alarm = ON	The input voltage is sufficient to enable connection to the grid: the inverter waits for the grid voltage to be present to make the connection to the grid.



The inverter is powered SOLELY by the voltage generated by the photovoltaic generator: the presence of grid voltage alone is NOT SUFFICIENT for the inverter to switch on.

- When the input voltage is sufficient to allow the connection to the grid, close the AC switch downstream of the inverter thus applying the grid voltage to the inverter: the inverter checks the grid voltage, measures the isolation resistance of the photovoltaic field with respect to ground and performs other auto-diagnostic checks. During the preliminary checks on the parallel connection with the grid, the “Power” LED keeps flashing, the “Alarm” and “GFI” LEDs are OFF.
- The inverter ONLY creates a parallel connection with the grid if the grid and isolation resistance parameters fall within the ranges foreseen by current regulations.
- If the outcome of the preliminary checks on the grid parallel is positive, the inverter connects to the grid and starts to export power to the grid. The “Power” LED remains fixed on while the “Alarm” and “GFI” LEDs are OFF.



To address any problems that may occur during the initial stages of operation of the system and to ensure the inverter remains fully functional, you are advised to check for any firmware updates in the download area of the website www.abb.com/solarinverters or at <https://registration.abbsolarinverters.com> (instructions for registering on the website and updating the firmware are given in this manual).



LED behaviour

The LEDs on the front panel may behave in different ways depending on the inverter's operational status.

All possible LED activation combinations are shown in the following table. In particular, each LED could behave in one of the following ways:







● = LED on

⊗ = LED flashing slow (2 seconds on / 2 seconds off)



















⊗ = LED flashing fast (0.2 seconds on / 0.2 seconds off)

○ = LED off

⊗ = Any one of the conditions described above

LED status	Operating state
green:  yellow:  red: 	Firmware programming The inverter firmware is being programmed
green: ○ yellow: ○ red: ○	Night mode (inverter automatically switches off) The inverter is in night time switch-off mode (input voltage less than 70% of the set start-up voltage).
green:  yellow: ○ red: ○	Inverter initialization This is a transitional state due to verification of the operating conditions. During this stage the inverter checks that the conditions for connecting to the grid are met.
green: ● yellow: ○ red: ○	The inverter is connected and is feeding power into the grid Normal operation. During this stage, the inverter automatically tracks and analyses the photovoltaic generator's maximum power point (MPP).
green:  yellow: ● red: ○	Disconnection from the grid Indicates lack of grid voltage. This condition does not allow the inverter to connect to the grid (the inverter display shows the message "Missing Grid").
green:  yellow: ● red: ○	Warning indication: (W message codes) or Error: (E message codes) - Indicates that the inverter control system has detected a warning (W) or error (E). It is possible to identify the type of problem generated with the Aurora Manager LITE software (see the alarm messages).
green: ○ yellow: ● red: ○	Temperature protection trip Indicates that the trip relating to internal temperatures (insufficient or excessive temperature) may have been activated
green: ○ yellow: ○ red: ●	Anomaly in the insulation system of the photovoltaic generator Indicates that a leakage to earth from the PV generator has been detected, causing the inverter to disconnect from the grid.



LED status	Operating state
green:  yellow:  red: 	<ul style="list-style-type: none"> • Ventilation anomaly Indicates an anomaly in the operation of the internal ventilation system that could limit output power at high ambient temperatures. • Overvoltage surge arresters triggered Indicates that any class II overvoltage surge arresters installed on the AC or DC side have been triggered • Autotest not executed (only for Italian network standards) On the inverter was not performed the Autotest • Internal statistics memory anomaly Indicates an operating anomaly in the internal memory on which the inverter statistics are stored • Buffer battery discharged The buffer battery is low and the inverter does not maintain the time setting
green:  yellow:  red: 	<ul style="list-style-type: none"> • Initial configuration failure The inverter is in locked state due to a failure in the initial configuration of the equipment, such as the standard network setting for the country of installation • Self-test not carried out (for Italian grid standards only) Self-test operation failure • Incompatibility of the device firmware versions The firmware versions of the various devices comprising the equipment are incompatible and are being updated (this is an automatic operation) • Temperature sensor anomaly detected
green:  yellow:  red: 	<ul style="list-style-type: none"> • Updating the firmware from an SD card The equipment firmware is being updated from an SD card
* lighting of the LEDs in sequence	<ul style="list-style-type: none"> • Firmware programming failure There has been a failure in programming the firmware, of one or more internal devices of the equipment, to the equipment from an SD card.
green:  yellow:  red: 	<ul style="list-style-type: none"> • Updating the firmware from an SD card completed The equipment firmware has been successfully updated from an SD card
green:  yellow:  red:  *blink 3 times	<ul style="list-style-type: none"> • Updating the firmware from an SD card has failed The equipment firmware update from an SD card has failed
green:  yellow:  red: 	<ul style="list-style-type: none"> • Remote OFF activated The Remote Off command has been activated. The unit will not connect to the network until the remote ON command has been activated



Description of the Web User Interface

The inverter is equipped with an advanced integrated Web User Interface and user interface that allow a full access to all configuration and commissioning parameters from any electronic device (laptop, tablet and smartphone).

Access to the Web User Interface

To access to the Web User Interface is required to connect a device equipped with wireless connection (such as tablet, laptop or smartphone).

Depending on the connection method chosen during the inverter commissioning phase ("Station Mode" or "AP Mode") it's required to follow one of the two procedures described below:

Connection to the inverter in "Station Mode"

- Enable the wireless connection on the device (tablet, smartphone or laptop) and connect it to the same wireless network to which the inverter is connected.
- Open an internet browser (recommended browser: Chrome versions from v.55, Firefox versions from v.50) and enter the links (corresponding to the IP Address assigned by the router to the inverter, or the "Host Name") provided during the commissioning phase to access the login page.

In order to use the "Host Name" as an alternative to the dynamic IP address, the Wi-Fi router to which the board is connected (when operating in "Station Mode") must provide the Domain Name System (DNS) service (contact the network administrator for further information regarding the presence or absence of the DNS service in the Wi-Fi router or how to enable it). In this way, even if the IP address assigned to the inverter should change over time, (dynamic IP), it will always be possible to use the same "Host Name" which will remain unchanged over time.

The IP address assigned may vary for reasons connected to the wireless home router setup (for example, a very brief DHCP lease time). If verification of the address is required, it is usually possible to obtain the client list (and the corresponding IP addresses) from the wireless router administration panel.

If the "Host Name" was lost, it could be obtained writing this url:

<http://ABB-XX-XX-XX-XX-XX-XX.local>

replacing the "X" with the hex digits of the MAC address of the inverter (it can be found on the "Communication Identification label" placed on the side of the inverter or applied during the commissioning phase to the plant documentation).

Connection to the inverter in “AP Mode”

- Enable the wireless connection on the device which is being used for the board setup (tablet, smartphone or PC) and connect it to the Access Point created by the inverter system: the name of the wireless network created by the system that the connection should be established with, will be:

ABB-XX-XX-XX-XX-XX-XX

where “X” is a hex digit of the MAC address (MAC address can be found on the “Communication Identification label” placed on the side of the inverter or applied during the commissioning phase to the plant documentation).

- When required digit the **PRODUCT KEY** (printed on the “Communication Identification label” and applied during the commissioning phase to the plant documentation) as access point password.

Note that it’s required to digit also the dash “-” characters of the Product Key in the password field.



In case of need, product key can be recovered by Aurora Vision Cloud or by calling ABB technical support.

- Open an internet browser (recommended browser: Chrome versions from v.55, Firefox versions from v.50) and enter the pre-set IP address **192.168.117.1** to access the login page.



Login page

After you have connected the device to the inverter and you access to the login page, login with the username and password created during the commissioning phase.

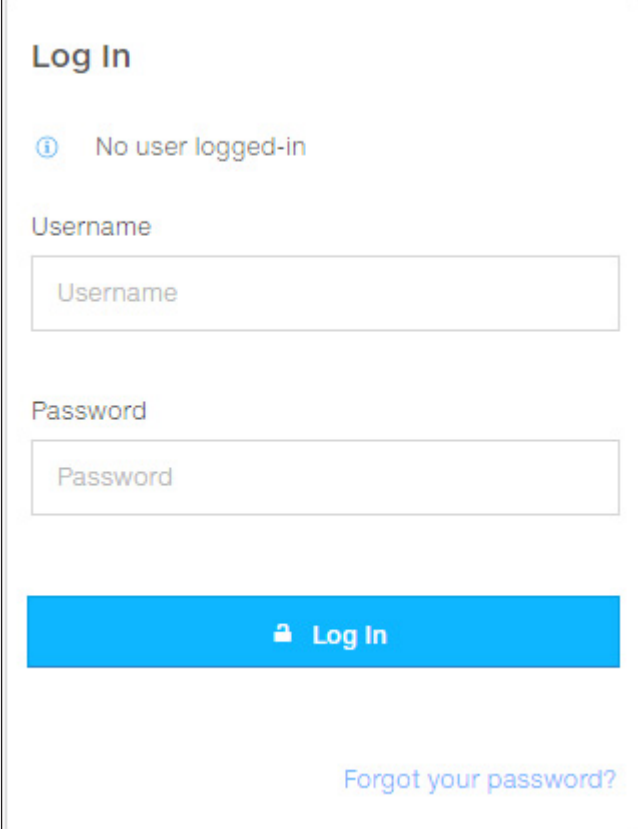

Log In

i No user logged-in

Username

Password

 Log In

[Forgot your password?](#)



User and password are CASE SENSITIVE.



If the Password is lost click on "Forgot your password?" to obtain the access to the Web User Interface (and it will be possible to change the password) by entering the PRODUCT KEY (printed on the "Communication Identification label" and applied during the commissioning phase to the plant documentation).



The language of the Web User Interface could be changed in any moment by clicking on the right status bar:

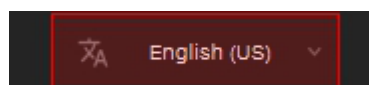

Web User Interface menu structure



The following screenshots are related from a laptop visualization, may differ from smartphone or tablet visualization.

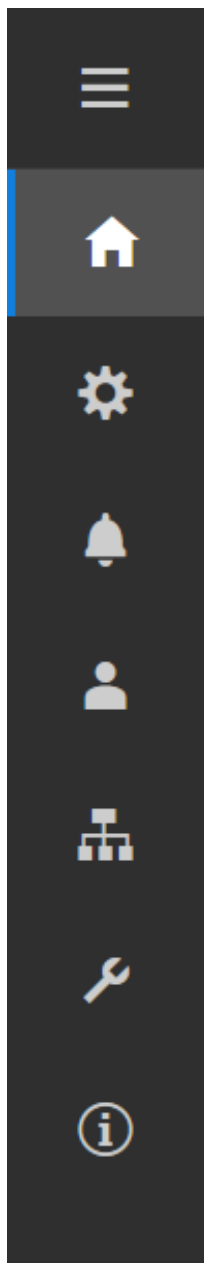

The Web User Interface is divided in six main sections, available on the left sidebar:

MAIN: Main section of Web User Interface dedicated to viewing the summary informations related the status and the production informations of the inverter and photovoltaic plant.

SETTING: Section dedicated to AC and DC line parameters configurations.

INVERTER LOG: Section dedicated to viewing Alarms and Warnings event log.

USER: Section dedicated to User management.

NETWORK SERVICES: Section dedicated to inverter communication settings and configurations.

SERVICE TOOLS: Section dedicated to main service tools configurations.

INFORMATION: Section dedicated for general informations about the embedded Web User Interface.





MAIN section

In the **MAIN** section it's possible to access the following sub-menus:

- **Dashboard**
- **Status Summary**

Dashboard

In the **Dashboard** sub-menu you can view the main informations related the status and the production informations of the inverter and photovoltaic plant and alarm/warning active events.

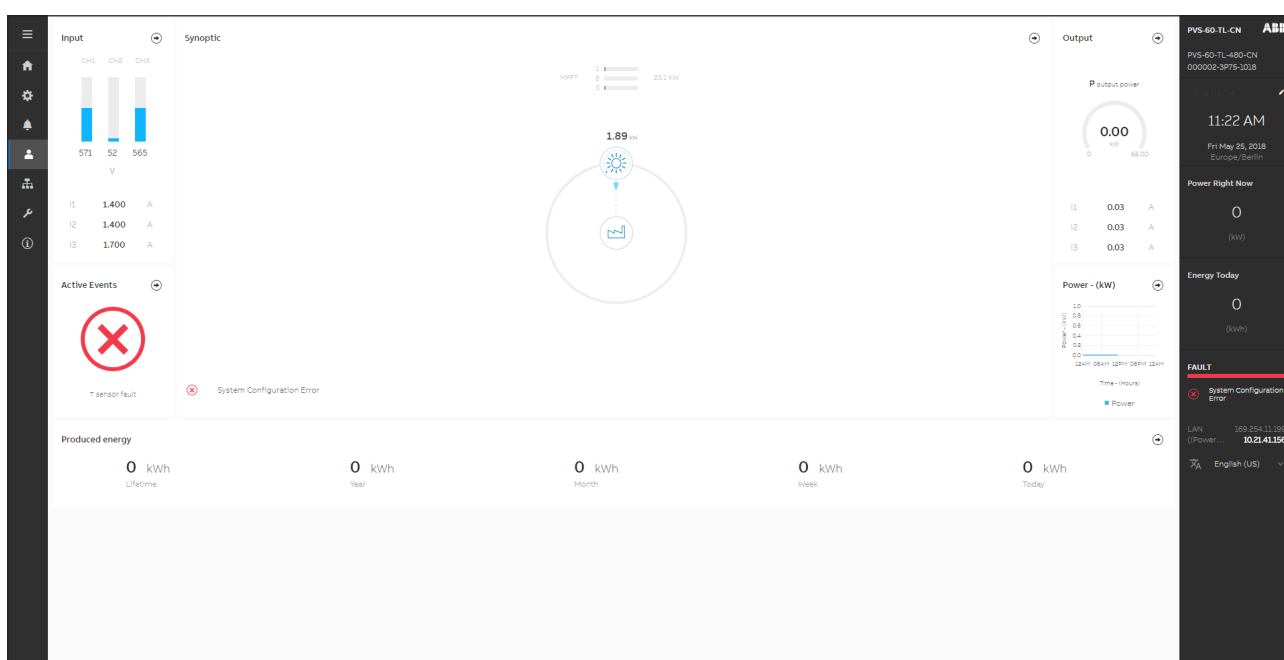

Status Summary

In the **Status Summary** sub-menu you can view the detailed informations related the status and the production informations of the system.

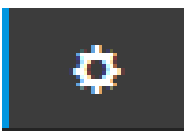

SETTING section

In the **SETUP** section it's possible to access the following sub-menus:

- **AC output Rating** (*Only visible with Admin Plus privileges*)
- **AC Settings** (*Only visible with Admin Plus privileges*)
- **Active Power Control** (*Only visible with Admin Plus privileges*)
- **DC Settings**
- **Digital Inputs**
- **Frequency Control: P(f)** (*Only visible with Admin Plus privileges*)
- **Ramp Control** (*Only visible with Admin Plus privileges*)
- **Reactive Power Control** (*Only visible with Admin Plus privileges*)

AC output Rating (Only visible and editable with Admin Plus privileges)

In the **AC output Rating** sub-menu you can config the output power limitation by changing the Maximum AC output power and the maximum apparent output power parameters.



Do not change these parameters if not requested by the grid operator.

AC Settings (Only visible and editable with Admin Plus privileges)

In the **AC Settings** sub-menu you can setup the parameter related to the Output AC side:



Changing the above-mentioned parameters may prevent disconnection from the grid if the new values exceed those given in the standards of the country of installation. If these parameters are changed to values outside the standard range, an interface protection must be installed external to the inverter in accordance with the requirements of the country of installation.



1. Grid Connection

By editing these settings it's possible to change the grid connection thresholds parameters to which the inverter have to connect to the grid

2. Grid Protections + VRT/FRT

By editing these settings it's possible to enable/disable and change the grid protection intervention thresholds parameters. In addition it is possible to change voltage ride through (HVRT, LVRT) and frequency ride through (HFRT, LFRT) settings.

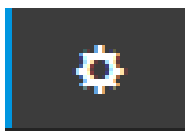

Active Power Control (Only visible and editable with Admin Plus privileges)

In the **Active Power Control** sub-menu you can config settings related to the active power derating parameters using the following parameters groups:

1. **Active Power Curtailment**
2. **CEI Average VGrid Derating**
3. **Volt/Watt settings: P(V)**



Do not change these parameters if not requested by the grid operator.

DC Settings

In the **DC Settings** sub-menu you can setup the parameter related to the Input DC side:

1. VStart 1 New Value

This parameter is used to sets the Vstart activation voltage for the input channel 1. This voltage imposes a minimum input voltage on the inverter above which connection to the grid will be attempted.

2. VStart 2 New Value

This parameter is used to sets the Vstart activation voltage for the input channel 2. This voltage imposes a minimum input voltage on the inverter above which connection to the grid will be attempted.

3. VStart 3 New Value

This parameter is used to sets the Vstart activation voltage for the input channel 3. This voltage imposes a minimum input voltage on the inverter above which connection to the grid will be attempted.



Change the activation voltage only if really necessary and to set it to the correct value: the photovoltaic generator sizing tool available on the ABB website will indicate whether Vstart needs to be changed and what value have to be set.

4. Input Mode - Independ / Parallel

This settings allows you to sets the input configuration mode.

5. UV Protection Time

This section of the menu allows you to sets the time for which the inverter stays connected to the grid after the input voltage has dropped below the Under Voltage limit (set at 70% of Vstart).

(60 seconds is the default setting).



6. Multiple Max Scan Enable

This settings allows you to Enables/disables the scan for identifying the maximum power point of the system.

7. Multiple Max Scan Period

This settings allows you to sets the time between scans. Remember that the shorter the scan interval the greater the loss of production, due to the fact that energy is transferred to the grid during the scan but not at the maximum power point. Each scan takes roughly 2 seconds.

Digital Inputs

In the **Digital Inputs** sub-menu you can disable or enable the Remote ON/OFF functionality related to the “Remote” terminal block [37](#).





Frequency Control: P(f) (Only visible and editable with Admin Plus privileges)

In the **Frequency Control: P(f)** sub-menu you can config settings related to the active power derating as function of grid frequency.



Do not change these parameters if not requested by the grid operator.

Ramp Control (Only visible and editable with Admin Plus privileges)

In the **Ramp Control** sub-menu you can config the parameter related to the active power ramp up at the start-up and after a grid fault event.



Do not change these parameters if not requested by the grid operator.

Reactive Power Control (Only visible and editable with Admin Plus privileges)

In the **Reactive Power Control** sub-menu you can configure settings related the reactive power parameters using the following parameters groups:

1. **Watt/Cosphi Settings: Cosphi(P)**
2. **Q Set**
3. **Cosphi Set**
4. **Volt/VAr Settings: Q(V)**



Do not change these parameters if not requested by the grid operator.



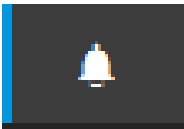

Inverter Log

In the **Inverter Log** Section it's possible to view the Alarm and Warning events list that it can be custom filtered by type or by entering a matching word.

Clicking on any event to view his details.

The screenshot displays the 'Inverter Log' interface. It features a dark sidebar on the left with navigation icons. The main content area has a search bar labeled 'Filter', date range selectors for '2018-04-25' and '2018-05-25', and buttons for 'CLEAR FILTERS' and 'REFRESH EVENTS'. Below these are tabs for 'ALL', 'EVENTS', 'UPDATES', and 'CHANGES'. A pagination bar shows '1 of 42' events. The event list contains multiple entries, each with a red circle icon, the text 'E080 error', and 'T SENSOR FAULT'. The events are timestamped with dates like 'May 25, 2018 11:22:01 AM'.



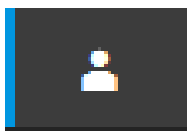

USER section

In the **USER** section it's possible to logout from Web User Interface and return to the login page, or to access the following sub-menus:

- **Edit Email and Password**
- **Admin Plus**
- **User Management**

Edit Email and Password

In the **Edit Email and Password** sub-menu you can change the e-mail and password related to the user which is used to login to the Web User Interface:

Admin Plus

By accessing to the **Admin Plus** sub-menu you can obtain the “Admin Plus” user privileges which allow you to:

- Change the grid standard of the inverter, after 24 hours while the inverter is operating (so the **Country Standard** sub-menu on **TOOLS** section is locked).
- View and edit the **AC Settings, Reactive Power Control, Ramp Control, Active Power Control and Frequency Control: P(f)**
- View and edit the “**MPPT Noise amplitude**” field in **DC Settings** on **SETUP** section.

To access on the Web User Interface with the “Admin Plus” user privileges it's required to enter a security token that can be obtained by registering on the website <https://registration.abbsolarinverters.com>. Refer to the dedicated section on this topic in the manual.

User Management

By accessing to the **User Management** sub-menu it's possible to edit all the users already created and create new users (both with admin or User privileges).



NETWORK Services

In the **NETWORK Services** section it's possible to access the following sub-menus:

- **RS485**
- **LAN**
- **WLAN**
- **Modbus**
- **Connectivity Check**
- **Debug Settings**

RS485

In the **RS485** sub-menu it's possible to adjust the settings relating to the RS485 communication serial line:

- RS485 Node Address: It allows you to set the address for serial communication of the individual inverters connected to the RS485 line. The UP and DOWN buttons scroll through the numerical scale. (The addresses that can be assigned are 2 to 63).
- RS485 Baud Rate: It allows you to set the Baud Rate (2400/4800/9600/19200/38400/57600/115200).
- RS485 Parity Mode: It allows you to set the Parity bit (No Parity, Even Parity, Odd Parity).
- RS485 Protocol Type: It allows you to set the type of protocol to be used for the RS485 line.
 - "Modbus Sunspec Server": General purpose communication protocol to be selected to enable monitoring and control.
 - "Device Acquisition": Communication protocol to be used in case of connection in "Master" mode to external devices (like VSN800 weather station).





LAN

In the **LAN** sub-menu it's possible to view the status and change the daisy chain configuration of the two ethernet ports of the inverter.

- Daisy chain configuration: DHCP or Static:

By selecting the DHCP function (default setup) the router will automatically assign a dynamic IP address to the inverter whenever it tries to connect to the user network.

With Static, the user can assign a fixed IP address to the system. The data which has to be entered in order for IP static address assigning to take place will appear. Complete the additional fields at the bottom of the screen (all the fields are mandatory with the exception of the secondary DNS server).

LAN Status

Daisy Chain

Linked interfaces:	ETH0, ETH1
IP Address:	10.21.39.51
Subnet Mask:	255.255.252.0
Gateway:	10.21.36.1
Primary DNS:	
Secondary DNS:	

Daisy chain configuration:

IP Settings

DHCP ▼

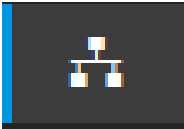

WLAN

In the **WLAN** sub-menu it's possible to view the status of the two wireless channels of the inverter, and to disconnect the channel 2.

- Channel 1: "Access Point mode": Only local communication is enabled in this mode; In particular, the WLAN acts like an «access point» generating a wireless network to which the user can connect locally, configure the inverter / photovoltaic system, using the direct access to the embedded Web User Interface

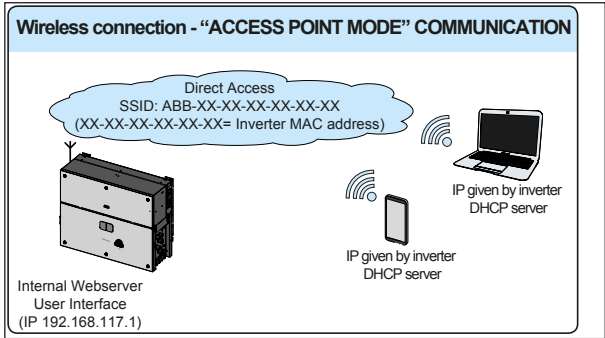

- Channel 2 "Station Mode": In this operating mode is possible to connect the inverter to a WI-Fi router; in this condition remote monitoring is enabled accessing to Aurora Vision® CLOUD platform.

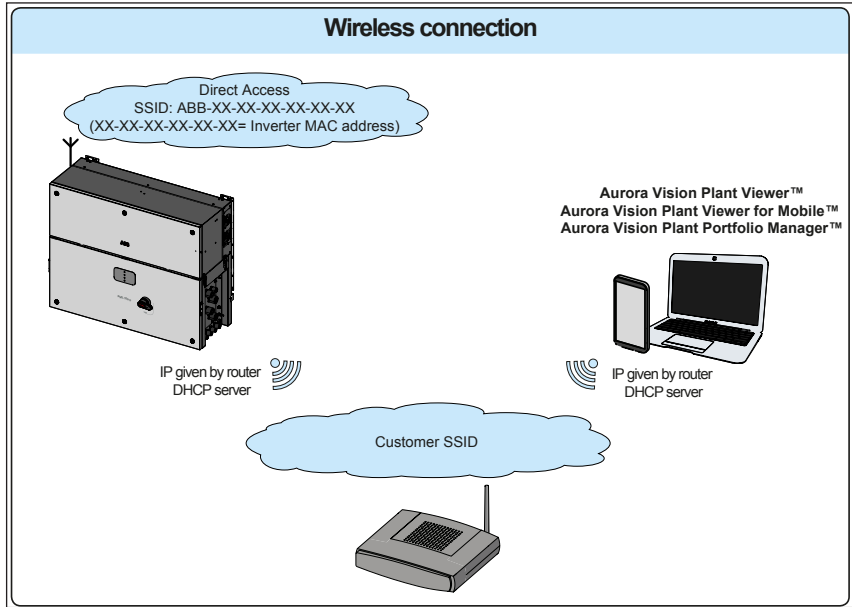

In case of connection to channel 2 (“Station Mode”), it will be required to enter the wireless network parameters (set on the router) and follow the subsequent procedure:

WLAN Status

Wireless channel 1

Mode: Access Point
 Status: **on**
 SSID: ABB-b0-72-bf-9f-0d-39
 IP: 192.168.117.1

Wireless channel 2

You are connected through the channel 2 (Station)

Mode: Station
 Status: **connected**
 Connected to: ((Power-One_Internal))
 Signal level: Strong
 IP: 10.21.43.188

Netmask: 255.255.252.0
 DNS:
 Gateway: it-r-valwificli

i Connect through the AP channel to change the connection status or the configuration of the station channel

DISCONNECT

Edit channel 2 configuration

IP Settings

DHCP

Available Network (SSID)

((Power-One_Internal)) **↻**

Password

password

Show password

Back **Switch to AP**

- IP Selection Mode: DHCP or Static:

By selecting the DHCP function (default setup) the router will automatically assign a dynamic IP address to the inverter whenever it tries to connect to the user network.

With Static, the user can assign a fixed IP address to the system. The data which has to be entered in order for IP static address assigning to take place will appear. Complete the additional fields at the bottom of the screen (all the fields are mandatory with the exception of the secondary DNS server).

- SSID (name of wireless network):

Identify and select your own (home) wireless network from all those shown in the SSID field (you can carry out a new search of the networks that can be detected with the Update button **↻**). Once the network has been selected, confirm.

- Password (wireless network password):

Enter the password for the destination network (if necessary) and start the connection attempt (it will take a few seconds).

Click on “Connect”

! **Please do not close this page and waiting a moment**

⌚ **Config initializing**

Please wait the network initialization before change to new network

Once the inverter is associated with a wireless network, the user must switch the tablet/smartphone/PC to the same wireless network which the inverter is connected.

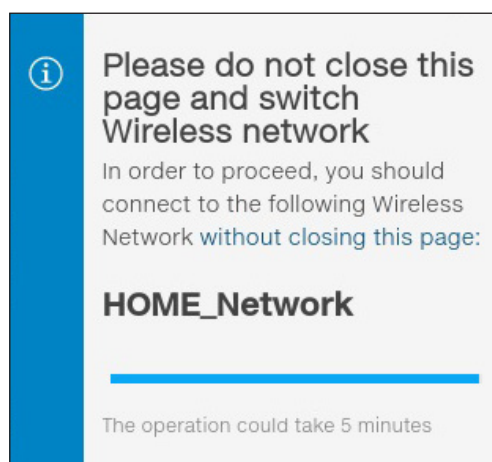

Once the tablet/smartphone/PC device is switched to the local wireless network a new message will confirm that the connection is acquired.

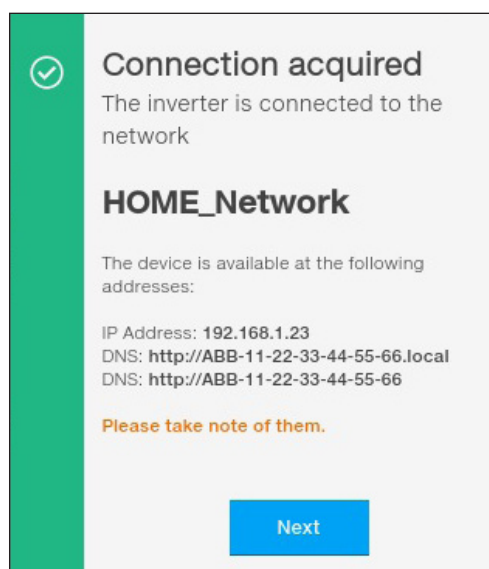

Click the “Next” button” to complete the setup of “Station Mode”



In order to use the “Host Name” as an alternative to the dynamic IP address, the Wi-Fi router to which the board is connected (when operating in “Station Mode”) must provide the Domain Name System (DNS) service (contact the network administrator for further information regarding the presence or absence of the DNS service in the Wi-Fi router or how to enable it). In this way, even if the IP address assigned to the inverter should change over time, (dynamic IP), it will always be possible to use the same “Host Name” which will remain unchanged over time.



The IP address assigned may vary for reasons connected to the wireless home router setup (for example, a very brief DHCP lease time). If verification of the address is required, it is usually possible to obtain the client list (and the corresponding IP addresses) from the wireless router administration panel.



Modbus

In the **Modbus** submenu it is possible to set the RTU inverter communication mode (RS485):

- type the "Edit" key and select the type of external device
- According to the device, select the communication protocol of the inverter

Moreover in the TCP / IP (WLAN / LAN) section there are different settings based on the type of external device connected to the inverter.

- If the inverter acts as CLIENT and the external device as SERVER:
 - type the "Edit" key and select the type of external device
 - According to the device, select the communication protocol
 - type in the [+] key and the added device is displayed
 - change the STATE / SLAVE ID / NAME / IP ADDRESS / PORT / DEVICE settings and save them.
- If the inverter acts as a SERVER, set the port communication protocol only (Communication protocol server)

Setting up communication over TCP/IP

[Edit WLAN](#)
[Edit LAN](#)

Communication protocol Server Sunspecs Protocol

Enabling monitoring of devices connected over Local Area Network

Used port

Add device -- Please select --

STATE	SLAVE ID	NAME	IP ADDRESS	PORT	DEVICE
<input type="button" value="Edit"/>					

Setting up communication over Serial Ports

RS485 Main - Node Address 1, Modbus SunSpec Server, 19200 bps, No Parity [Edit RS485](#)

Enabling monitoring of devices connected over Serial Ports

Operating mode Modbus SunSpec Server

To add a device you should switch to device acquisition operating mode

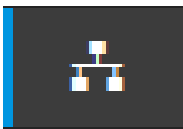

Connectivity Check

In the **Connectivity Check** sub-menu it's possible to carry out connectivity tests of the wireless network connection, ethernet connection, connection to Aurora Vision and firmware upgrade servers.

At the end of the test it will be reported the detail of the results.

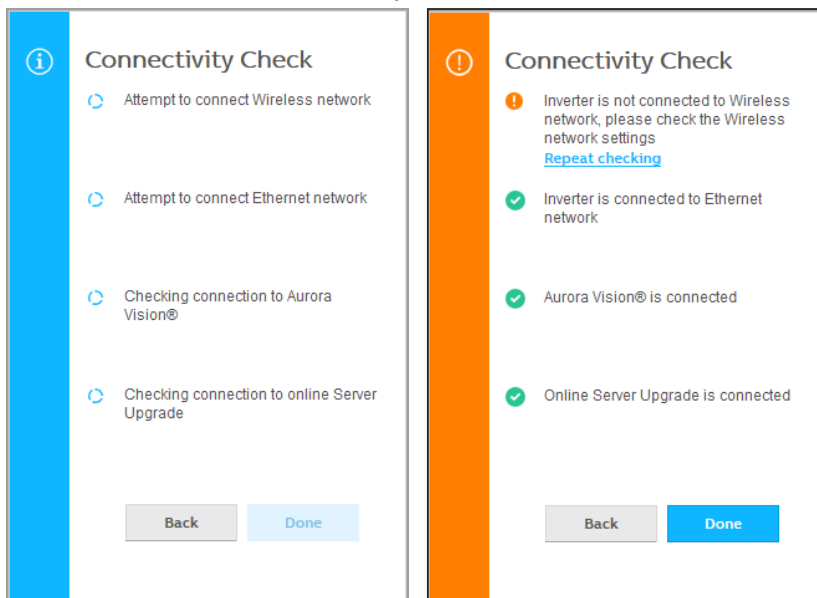

Debug Settings

In the **Debug Settings** sub-menu it's possible to enable or disable the Debugging access for ABB Service purposes.



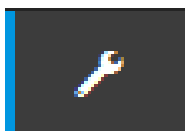

Service TOOLS

In the **Service TOOLS** section it's possible to access the following sub-menus:

- **Digital Output management**
- **Country Standard**
- **Firmware Update**
- **Date/Time**
- **Reset Manufacturing** (*Only visible with Admin Plus privileges*)

Digital Output Management

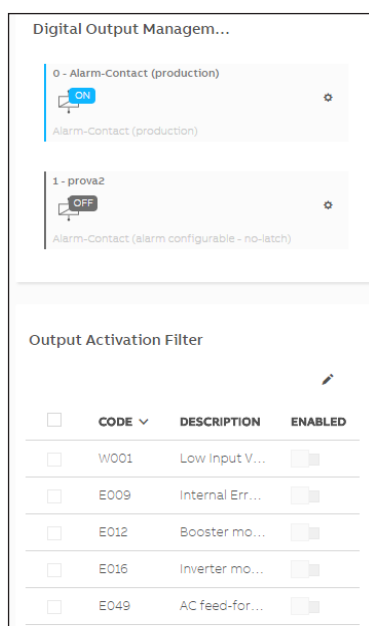

This section of the menu allows you to set the activation status of a relay (available either as contact normally open – N.O. - and as a normally closed contact -N.C.) and to configure customised alarm conditions.

This contact can be used, for example, to: activate a siren or a visual alarm, control the disconnect device of an external transformer, or control an external device. A little description of the alarm type (e.g. “alarm lamp”) is required.

Relay switching can be set in different modes using the setting icon :

With “Output active filter” you can select the list of events for which the relays switch.

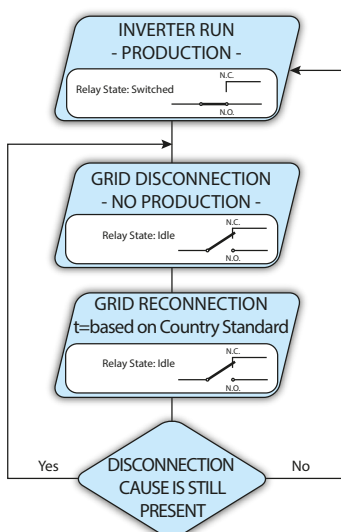

• **Alarm-Contact (Production)**

The relay is activated (status: switched) whenever the inverter connects to the grid; as soon as the inverter is disconnected from the grid (for whatever reason that caused disconnection), the relay is in its resting position.

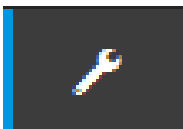

• **Alarm-Contact (alarm ALL - no-latch):**

The relay is activated (status: switched) whenever an error (code Exxx) or warnings related to grid parameters out of range (Warning – codes W003, W004, W005, W006, W007) are present on the inverter. The alarm returns to its resting position when the alarm signal ends, i.e. before the inverter checks the grid parameters after the alarm state. This is because grid control state is not an alarm state but a state of normal operation.

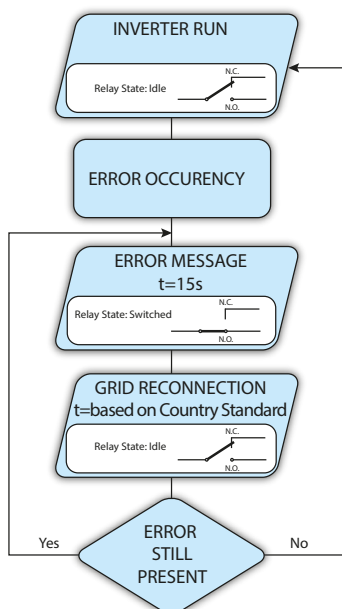

Selectable alarms for which the relay is activated

E001	E002	E003	E004	E005	E006
E007	E010	E011	E013	E014	E015
E017	E018	E019	E020	E021	E022
E023	E025	E029	E031	E032	E033
E034	E036	E037	E053	E055	E075
E077	E078	E079	E080	E084	W002
W004	W005	W006	W007	W011	W015
W017	W046	W047	W048		



In the presence of W003, W004, W005, W006, W007 signalling, the alarm contact switches to then reset itself at the end of the alarm signal. This means that during the absence of grid voltage (display message “Missing Grid”) the alarm contact remains in its resting position.

• **Alarm-Contact (alarm configurable - no-latch)**

The relay is activated (status: switched) whenever an error (code Exxx) or a warning (code Wxxx) is present from those selected from the list in the dedicated submenu **Output Activation Filter** of the inverter display. The contact returns to its resting position when the alarm signal ends, i.e. before the inverter checks the grid after the alarm state. This is because grid control state is not an alarm state but a state of normal operation.

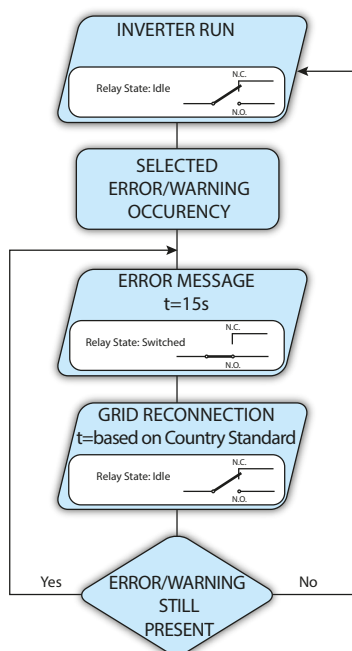

Selectable alarms for which the relay is activated

E001	E002	E003	E004	E005	E006
E007	E010	E011	E013	E014	E015
E017	E018	E019	E020	E021	E022
E023	E025	E029	E031	E032	E033
E034	E036	E037	E053	E055	E075
E077	E078	E079	E080	E084	W002
W004	W005	W006	W007	W011	W015
W017	W046	W047	W048		



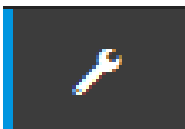

For the configurable relay operating mode “Alarm Conf.”, the following considerations are valid:

If the alarm condition is persistent, the alarm contact cyclically switches from its resting state to its activated state.



In the presence of W002 signalling (Input UV – input voltage below the limit of operation), the alarm contact switches to then reset itself at the end of the alarm signal. This means that during the reduced input voltage (display message “Waiting Sun”) the alarm contact remains in its resting position.

In the presence of W003, W004, W005, W006, W007 signalling, the alarm contact switches to then reset itself at the end of the alarm signal. This means that during the absence of grid voltage (display message “Missing Grid”) the alarm contact remains in its resting position.

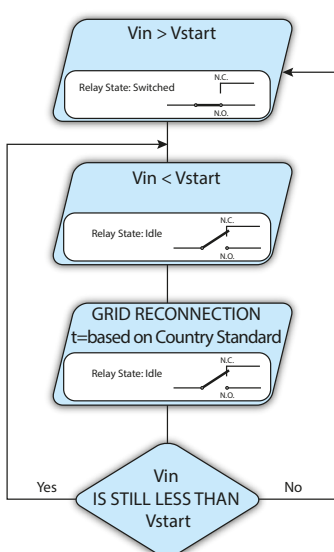

• Alarm-Contact (crepuscular):

The relay is activated (status: switched) as soon as the inverter input voltage exceeds the activation voltage set.

The relay switch to rest position when the input voltage drops below 70% of the activation voltage set.

This mode is useful for disconnecting any output transformers that could have unnecessary consumption during the night.

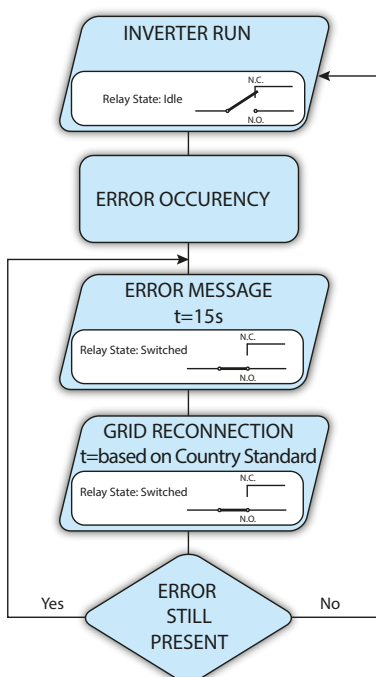

• Alarm-Contact (alarm ALL - latch):

The relay is activated (status: switched) whenever an error (code Exxx) or a warning (code Wxxx) is present. When the inverter returns to the normal operating state and reconnects with the grid, the contact returns to its position of rest.

Selectable alarms for which the relay is activated

E001	E002	E003	E004	E005	E006
E007	E010	E011	E013	E014	E015
E017	E018	E019	E020	E021	E022
E023	E025	E029	E031	E032	E033
E034	E036	E037	E053	E055	E075
E077	E078	E079	E080	E084	W002
W004	W005	W006	W007	W011	W015
W017	W046	W047	W048		

If the alarm condition is persistent, the relay will remain activated (status:switched)

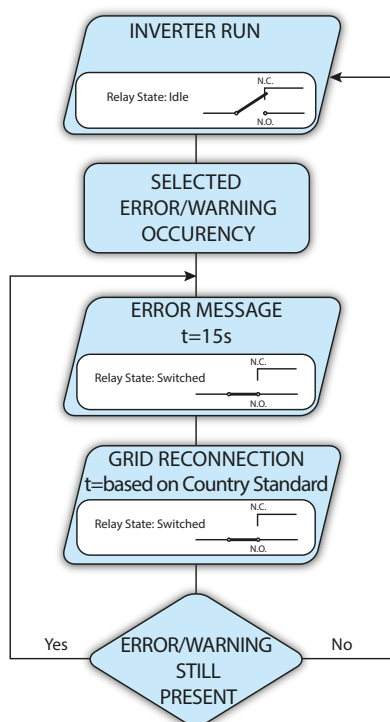
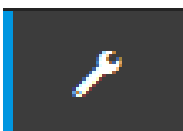

• **Alarm-Contact (alarm configurable - latch):**

The relay is activated (status: switched) whenever an error (code Exxx) or a warning (code Wxxx) is present from those selected from the list in the dedicated submenu **Output Activation Filter** of the inverter display (see the table below). When the inverter returns to the normal operating state and reconnects with the grid.

Selectable alarms for which the relay is activated

E001	E002	E003	E004	E005	E006
E007	E010	E011	E013	E014	E015
E017	E018	E019	E020	E021	E022
E023	E025	E029	E031	E032	E033
E034	E036	E037	E053	E055	E075
E077	E078	E079	E080	E084	W002
W004	W005	W006	W007	W011	W015
W017	W046	W047	W048		

If the alarm condition is persistent, the relay will remain activated (status:switched)

• **Alarm-Contact (alarm configurable - matrix):**

In this mode, it is possible to configure the behaviour of the alarm relay according to an error table which can be setup with the Web User Interface. In the table it is possible to select the alarms or warnings for which the alarm relay is activated (status: switched); for each individual alarm it is also possible to select the “Latch” or “No Latch” mode.

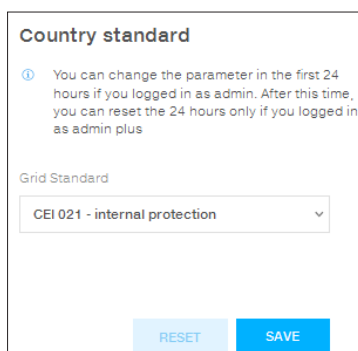

Country Standard

By accessing to the **Country Standard** sub-menu you can modify the grid standard within 24 hours while the inverter is operating.



*After the grid standard was set you have 24 hours to make any changes to the grid standard value; 24 hours later the **Country Standard** sub-menu will be locked, and any subsequent changes can only be made accessing with **Admin Plus** privileges. Refer to the dedicated section on this topic in the manual to know how to unlock the **Country Standard** sub-menu.*

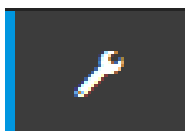

Firmware Update

By accessing to the **Firmware Update** sub-menu you can upgrade the firmware of the inverter and his components selecting a Remote firmware Update or a Local firmware Update.



Perform the update during good irradiation conditions (avoid the dawn and dusk hours). An interruption of updating process could damage the inverter!

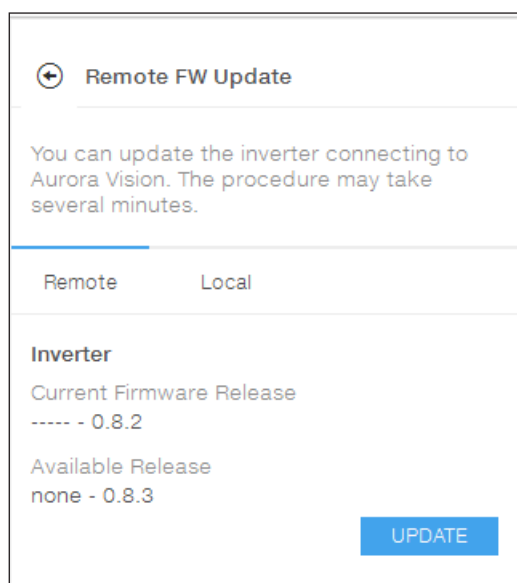

• Remote firmware Update:

- In remote mode, the firmware will update automatically, searching the last available firmware on ABB servers, by clicking the “CHECK” button.

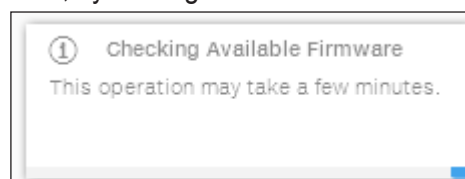

- After the finish of the checking process the available release will be notified on the bottom part of the section
- Click on “UPDATE” button to start with the updating process.

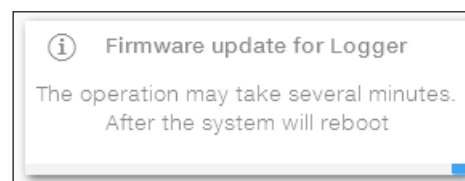

• Local firmware Update:

By updating in local mode, the firmware have to be selected and uploaded from local folder of the used devices to access to the web server. The latest firmware version is available from the download area of the website www.abb.com/solarinverters or from <https://registration.abbsolarinverters.com>

- Click on “FW SELECT” and select the firmware package previously downloaded.

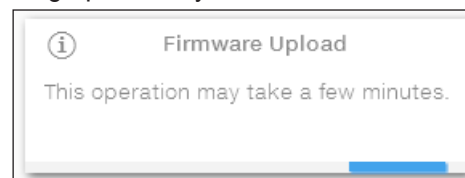

- Click on “UPDATE” button to start with the updating process.

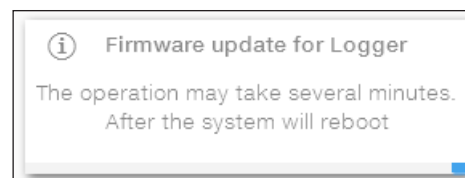

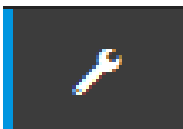

Date and Time

In the **Date and Time** sub-menu it's possible to sets the date, time and time zone.

The inverter will propose these fields when the time protocol is available).

When it's not possible for the inverter to detect the time protocol, these fields have to be manually entered.

Date and Time

✔ Network Time Protocol server has been detected and it will be used to keep the system clock synchronized.

Date ✔

Feb 22, 2017

SET by the NTP server

Time ✔

4:52 PM

SET by the NTP server

Time Zone

Europe/Berlin GMT+01:00 ▾

SAVE



Reset Manufacturing *(Only visible with Admin Plus privileges)*

In the **Reset Manufacturing** sub-menu it's possible to reset country standard, restore default and the connectivity reboot.



INFORMATION

In the **INFORMATION** Section it's possible to view the general informations about the embedded Web User Interface.

it's possible to access the following sub-menus:

- **Product Info**
- **Privacy Policy**
- **Provider Information/Impressum**
- **Acknowledgments**
- **Release Notes**



Inverter switch-off



Some parts may be very hot and could cause burns.



Some inverter parts may be subject to voltages that could be hazardous for the operator. Before performing any work on the inverter, follow the procedure for turning off the inverter.

Operator and maintenance personnel skills/prerequisites



Personnel in charge of using and maintaining the equipment must be skilled for the described tasks and must reliably demonstrate their capacity to correctly interpret what is described in the manual.



For safety reasons, only a qualified electrician who has received training and/or demonstrated skills and knowledge of the inverter's structure and operation may install the inverter.



The installation must be performed by qualified installers and/or licensed electricians in accordance with the existing regulations in the country of installation and in accordance of all safety rules for performing electrical works.



Inverter operation and maintenance by a person who is NOT qualified, is intoxicated, or on narcotics, is strictly forbidden.



The customer has civil liability for the qualification and mental or physical state of the personnel who interact with the equipment. They must always use the personal protective equipment (PPE) required by the laws of the country of destination and whatever is provided by their employer.



Required tools

- MC4 disconnect tool
- Voltage detector (EN 61243-3)
- DC current clamp
- Safety tags “work in progress, do not operate”
- Padlocks

Required PPE

- Dielectric helmet EN397 – EN50365 1000V with visor EN166 grade 8
- Insulating gloves class 0 (1000V) EN 60903
- Protective overglove in leather EN420 – EN388 - Alternatively use insulating composite gloves cat. 0 en60903 resistant to electric arc class 2 7ka en61482-1-2)
- Work overall UNI EN 11612 A B1 C1 resistant to electric arc class 2 (7kA 1s.) CEI EN 61482-1-2
- Safety shoes

Switch-off procedure

1. Preliminary checks

- PPE Check: Verify the integrity of the PPE that is going to be used to perform the operations.
- Equipment check: Check the voltage tester is working correctly.

2. Wear the appropriate PPE for carrying out the operations (overall resistant to electric arc, dielectric helmet with visor, insulating gloves). All the following activities (till the completion of the procedure) must be performed wearing the PPE.

3. Check the absence of dangerous voltages on inverter chassis respect ground:

- Check the absence of dangerous voltage on the inverter chassis. The measurement point are between inverter chassis and a ground point outside the inverter.

4. Operations on External AC source

- Disconnect any AC external sources.
- Affix designated lock preventing operation onto any external AC disconnect device, affixing designated tags.
- Check on the status LEDs ①⑤ the shutdown command has been carried out: **Missing Grid:** Power LED (Green) Flashing – Alarm LED (Yellow) on (solid).

5. Operations on External DC source

Note: In case of absence of External DC disconnect device go on the section (Operations on internal DC Switch)

- Disconnect any DC external sources
- Affix designated lock preventing operation onto any external DC disconnect device, affixing designated tags.
- Check on the status LEDs ①⑤ the shutdown command has been carried out: **Missing DC voltage:** All LEDs OFF.

6. Operations on Internal DC disconnect switches ①⑤

- Open DC switches ①⑤ .
- Affix padlocks and tags to inhibit the re-closing operation.
- Check on the status LEDs ①⑤ the shutdown command has been carried out: **Missing DC voltage:** All LEDs OFF.



7. Remove the DC cables from the PV connectors ①⑨②①

- Using the current clamp check the absence of current on DC side, measurement each positive and negative DC input string, refer to red area (check the correct setting of the current sensor).

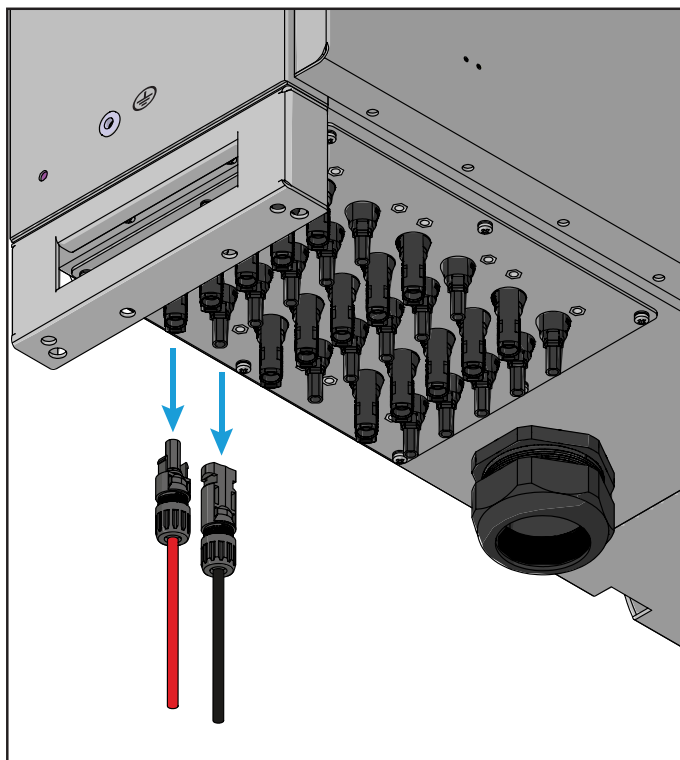

- Remove all quick fit DC connector ①⑨②① (PV Connector) from the wiring box. To avoid mechanical interferences, use a cable tie to collect the disconnected cables.

**8. Discharge of the capacitor**

- Wait the internal capacitors to be discharged. The discharge time of the stored energy, is indicated on the regulatory label – 30 minutes.

9. Voltage absence check on DC side

- Access to the wiring box by opening the front wiring box cover ④.
- Visually inspect the components to identify the presence of any overheating, signs of electric arcs, failure of the insulating devices.

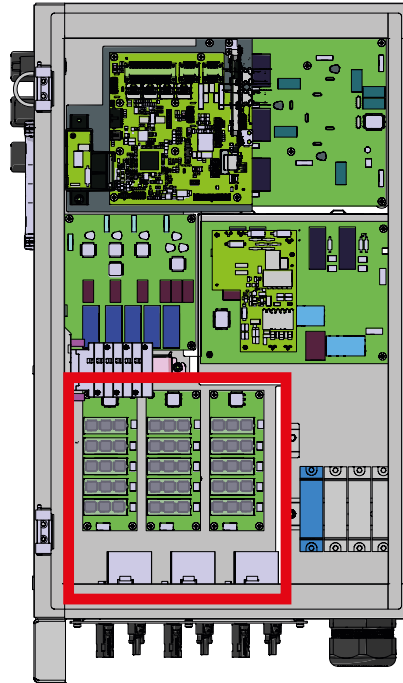

10. Check the absence of voltage on the DC terminal block using the VAT

- Check the absence of voltage on the DC terminal block measuring between “Positive (positive side string fuses board ③⑤) and protective earth terminal ③⑦”.

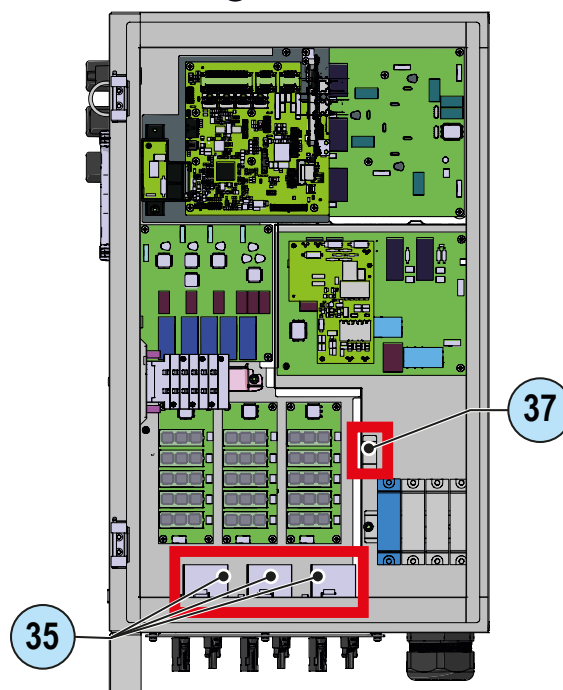

- Check the absence of voltage on the DC terminal block measuring between “Negative (⊖ or 34 based on the product model) and protective earth terminal 37”.

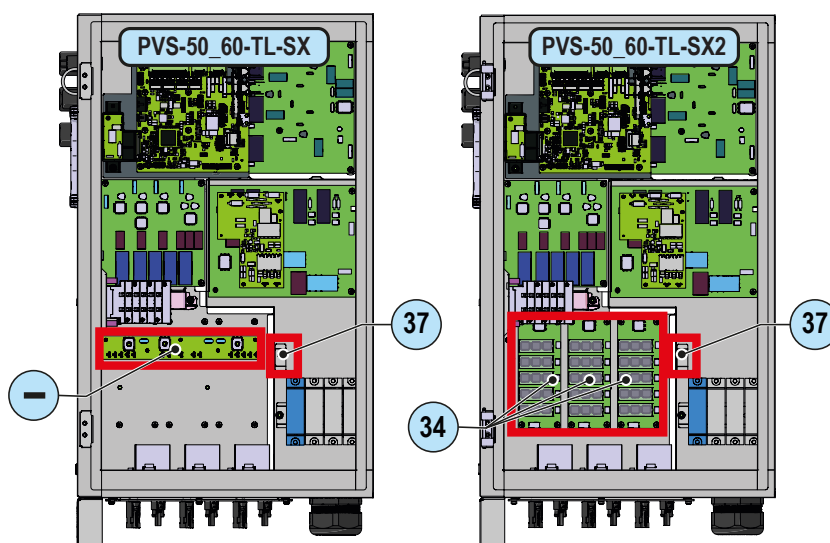

- In case of absence of voltage between “Positive-earth” and “Negative-earth” check that there is no voltage on the all DC branches coming from the photovoltaic field, measuring between all the points: +DC input / -DC input.

11. Voltage absence check on AC side

- Check there is no voltage on the AC terminal blocks downstream of the external AC breaker, measuring between: each phase to PE - Neutral to PE - each Phase to other Phases – each Phase to Neutral

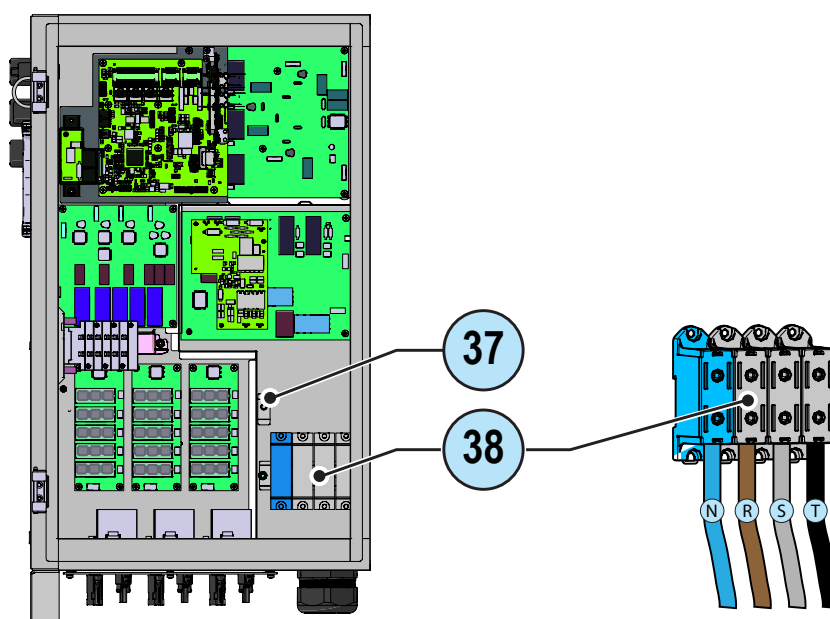

12. Check list to be filled prior the access to the inverter

- Purpose of the checklist is to verify that all the operations mentioned in the procedure have been carried out. The checklist below must be attached to the intervention report.

CHECK	STATUS \surd or X
Prepare for the work and identify the work location and equipment	
PPE and Equipment Check	
PPE wearing	
OPERATIONS AT PLANT LEVEL [*]	
Check the absence of dangerous voltages on inverter chassis respect ground	
Operations in External AC switch	
Operations in External DC Switch	
OPERATIONS AT INVERTER LEVEL	
DC disconnects – Inverter Side (opening and LOTO of DC switches in all power compartments)	
Remove the DC cables from the terminal block	
Wait the discharge of the internal capacitor	
VOLTAGE ABSENCE TEST	
Voltage absence check on DC side	
Voltage absence check on AC Side	
ISSUE WORK PERMIT	
Issue work permit and “Walk the permit” – Check list filling	
== ONLY if all checks are POSITIVE () the ACCESS IS ALLOWED =	

[*]: Identification of the external switch may require the cooperation of the plant manager and it must be included in the switching plan defined during the preparation of the work.





Maintenance

8

General conditions

Routine and periodic maintenance operations must only be carried out by specialized staff with knowledge of how to perform these tasks.



Some inverter parts may be subject to voltages that could be hazardous for the operator. Before performing any work on the inverter, refer to “Inverter switch-off” chapter on this manual to know all the necessary step to safely operate on the inverter.



For cleaning, DO NOT use rags made of filamentary material or corrosive products that may corrode the equipment or generate electrostatic charges. Avoid temporary repairs. All repairs should be carried out using only genuine spare parts. The maintenance technician is to promptly report any anomalies.

DO NOT allow the equipment to be used if problems of any kind are found.



Always use personal protective equipment (PPE) provided by the employer and comply with local safety regulations.



Routine maintenance

Routine maintenance operations should not be considered obligatory, but rather as recommended in order to maintain the efficiency of the PV system.

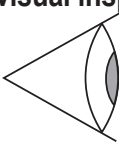

It is recommended that maintenance operations are only performed by qualified personnel or ABB personnel (under a servicing contract). The maintenance schedule may vary depending on the environmental conditions of the installation premises.

Table: routine maintenance

<p>Annual visual inspections</p> 	<ul style="list-style-type: none"> • Check that the inverter is operating properly, without any alarm signals • Ensure all labels and safety symbols are visible • Check the integrity of the cables, connectors and cable glands outside the inverter • Check that the environmental conditions have not changed dramatically from those on installation. • Check there are no obstacles (animals, insects, leaves, vines or plants growing in heat sink, or anything which could reduce the heat exchanging capacity of the heat sink) at the top, at the bottom and between the fins.
<p>Annual operations</p> 	<ul style="list-style-type: none"> • Check the tightening of the cable glands and the screw terminal blocks • Check the front cover is secured to the wiring boxes • If there is no monitoring system, check the record of alarms and errors using the indications provided in the manual in order to check recent notification of recent malfunctions. • For the models with AC+DC disconnect switch, it is recommended that once a year the disconnect switch is operated a number of times (at least 10) to keep the contacts clean and prevent oxidation. This operation must be carried out in periods with low input power or at night.
<p>Annual cleaning</p> 	<ul style="list-style-type: none"> • Clean the equipment; verify, in particular, clean the lower array of the cooling fan assembly and the heat sink.



Troubleshooting



Operations on the inverter to identify and address any faults may only be performed by the installer or by qualified personnel.

Internal Webserver and wireless communication troubleshooting

The following table gives a list of main and common errors or problems relating to the wireless communication between inverter and user devices.

Problem	Possible causes	Solution
The internal webserver cannot be accessed.	ADMIN or USER password forgotten.	Reset the passwords by clicking on "Forgot your password"; The passwords can be reset after having entered the "Product Key" code that can be found on the "Wireless Identification Label".
The inverter is able to identify a wireless network but is unable to connect to it.	The signal between the inverter and the wireless router to which the board wants to connect is too weak.	Modify the position of the wireless antenna, the inverter or the router.
		Make sure that the inverter has not been installed near obstacles which could affect the communication with the wireless router (for example: metal cages or walls, walls in reinforced concrete, electromagnetic fields).
		Move the router as close as possible to the inverter.
The Inverter has not identified the wireless network to which connection is required.	The wireless network to which the inverter is to be connected, could require the user to enter a username and password to allow navigation (for example, with a public wireless network or a hotel).	Unfortunately the inverter cannot be connected to these types of wireless networks. Connect the inverter to an alternative wireless network.
	The wireless network to which the Inverter is to be connected, is set so as not to be identified (hidden network).	The Inverter is not able to connect to a hidden network. Set the wireless network to which the inverter is to be connected (visible network), then identify and connect the Inverter to the wireless network as normal.
The wireless board does not communicate correctly with the inverter inside of which it is installed (inconsistency in the detected data read by the board), or when working in "Access Point Mode", it's not possible to access the internal webserver.	The signal between the inverter and the wireless router to which the board wants to connect is too weak.	Modify the position of the wireless antenna, the inverter or the router.
		Make sure that the inverter has not been installed near obstacles which could affect the communication with the wireless router (for example: metal cages or walls, walls in reinforced concrete, electromagnetic fields).
		Move the router as close as possible to the inverter.
The wireless board does not communicate correctly with the inverter inside of which it is installed (inconsistency in the detected data read by the board), or when working in "Access Point Mode", it's not possible to access the internal webserver.	The wireless board of the inverter could be damaged.	Request a service intervention to check that the inverter wireless board is working correctly.
	Wrong Inverter Date/Time settings.	Check if Date/Time has correctly set on the inverter; correct it if necessary.
Alternating difficulties in the local connection to the internal webserver.	The inverter might not be correctly powered (for example, if the inverter is switched off at night, the internal webserver cannot be accessed).	Access to the internal webserver only when the inverter is correctly powered.
	The wireless connection signal between the device in use and the router or the Inverter, may not have sufficient power or it may be disturbed by obstacles which affect the communication.	Make sure that the signal between the wireless devices which interact with the inverter are sufficiently high and that any obstacles such as metal cages or walls, walls in reinforced concrete or strong electromagnetic fields do not affect communication.

Problem	Possible causes	Solution
Although the Inverter has been configured correctly in "Station Mode" and works correctly on the local network, no data has been transmitted to the Aurora Vision®.	The MAC address used to register the inverter on the Aurora Vision® platform is not the same as the actual address associated with the inverter.	Make sure that the MAC address registered on the Aurora Vision® platform is actually the one associated with the inverter. If it is not, modify the registered MAC address.
	The wireless network to which the Inverter is connected, could be protected by a Firewall which prevents the remote exchange of data with the Aurora Vision® platform.	Contact the network administrator in order to have the Firewall configured so that the remote exchange of data between the Inverter and the Aurora Vision® platform is allowed.
It is not possible to access the Internal webserver using the IP address when the inverter is operating in "Station Mode – DHCP".	An incorrect dynamic IP address is being used to access the Internal Webserver or the IP address could have been modified by the wireless router to which the inverter is connected.	Access the Internal Webserver using via "AP Mode" (refer to dedicated section to know how to connect via "AP Mode") and read the current IP Address in " NETWORK > WLAN " section.
		Access the Internal Webserver using the "HostName" that could be obtained writing this url http://ABB-XX-XX-XX-XX-XX-XX.local replacing the "X" with the hex digits of the wireless MAC address of the inverter (it can be found on the "Wireless Identification Label" placed on the side of the inverter or applied during the commissioning phase to the quick installation guide on cover page). The DNS or multicast service must be enabled on router. Note: This connection method doesn't work on Android devices.
	The IP Address used to access the Internal Webserver was lost.	Access the inverter display menu WLAN Logger>Info>View IP to obtain the IP Address assigned by the router to the inverter. If possible, access the pages of the wireless router web server to which the inverter is connected and read the new dynamic IP address assigned to the Inverter.
	The wireless router doesn't allow the connection to local IP address. Typically this happen on company networks.	Contact the network administrator to allow the wireless router to connect to local IP address.
	The device doesn't allow the connection to local IP address. Typically this happen with company devices.	Contact the system administrator to allow the device to connect to local IP address.
Using an Android devices, a notification advise that internet connection is missing when trying to connect to the Access Point wireless network created by the inverter and ask for connection confirmation.	Known behavior of Android devices. Android OS always check if internet connection are available and ask for confirmation if it's not present.	Confirm the connection request in the notification of Android devices by clicking "Yes".
It is not possible to view the Pdf Autotest report using an Ios devices.	Popup opening is not allowed on Ios browser.	Allow the popup opening in the browser settings of the Ios devices (A notification will advise you for enable popup when trying to view the pdf autotest report).



Alarm Messages of the Inverter







In order to understand and resolve warning (Wxxx) or error (Exxx) signals that appear in the Alarm section of the internal webserver or on the inverter's display, follow the table given in the following paragraph.

The equipment can notify errors/warnings in the Alarm section of the internal webserver or on the display (where present) only if the input voltage is greater than the Vdcmín voltage (POWER Led flashing or lit; see chapter on operation)









The messages and related codes are shown in the Alarm section of the internal webserver or on the display.

The following table gives the complete list of errors/warnings relating to string inverters. Some error/warning codes may not be used depending on the inverter model installed.

- Error code - Error message - Warning	Name of Alarm and Cause	Solution
- No code - Ground F - Red LED	Ground fault of photovoltaic generator: The alarm is generated when a leakage current to ground is detected in the DC section of the system.	<ul style="list-style-type: none"> • Measure the isolation resistance using a megohmmeter positioned in the photovoltaic array (positive terminal short-circuited at the negative pole) compared to ground. The measurement is strongly influenced by the environmental conditions, so must be made under the same conditions in which the error occurred. - If the value measured is lower than 1 megaohm, a check must be carried out by a technician/installer on the photovoltaic generator to identify and eliminate the problem. - If the value measured is higher than 1 megaohm and the error signal persists, contact customer assistance.
- No code - NEW SYSTEM PART REFUSED! - Flashing yellow LED	Lack of linkage of the new system part: The components inside the inverter (e.g. display, fuse board, communication and control board, etc.) are not inter-linked. This occurs following the replacement of one of the components inside the inverter.	<ul style="list-style-type: none"> • Link the components inside the inverter by accessing the "Settings > Service > Accept boards" (refer to the procedure given in this manual). - If the signal persists also following the linking of the components, contact customer assistance.
- No code - SET COUNTRY or NO NATION - No LED	SET COUNTRY or NO NATION: Indicates that in the installation phase the grid standard was not set on the inverter.	<ul style="list-style-type: none"> • Set the grid standard of the country of installation following the instructions given in this manual for the inverter. - If the signal persists also after the grid standard has been set, contact customer assistance.
- No code - Missing Grid - Yellow LED	Missing Grid: The inverter does not detect grid voltage (AC side).	<ul style="list-style-type: none"> • Check the grid voltage on the inverter's AC terminal block. - Should it be absent, check any protection work on the line and the presence of grid voltage on the supply point.
- No code - Memory fault - Flashing yellow LED	Memory fault: The inverter has detected a communication problem with the memory board on which the inverter saves the daily value of energy produced.	<ul style="list-style-type: none"> • Remove the memory board and check the welding of all the connector's terminals. Subsequently reinsert the memory board and check that it is correctly inserted into the dedicated slot - If the signal persists also following the above checks, contact customer assistance.
- No code - Waiting Sun - Flashing green LED	Waiting Sun: The inverter goes into the "Waiting Sun" stage when, following a W001 and/or W002 warning, the voltage from the photovoltaic generator is less than the activation voltage (Vstart).	<ul style="list-style-type: none"> • Check the input voltage on the inverter. - If it does not exceed Vstart, check for the presence of sufficient irradiation and the correct composition of the system. - If it exceeds Vstart, contact customer assistance
- W001 - Sun Low - Yellow LED	Insufficient irradiation (Low input voltage on switching on the inverter): Incorrect configuration of the PV generator or an "on the limit" configuration for the inverter's minimum input voltage.	<ul style="list-style-type: none"> • Check the input voltage on the inverter. - If it does not exceed Vstart, check for the presence of sufficient irradiation and the correct composition of the system. - If it exceeds Vstart, contact customer assistance
- W002 - Input UV - Yellow LED	Insufficient irradiation (Low input voltage on switching off): Incorrect configuration of the photovoltaic generator or an "on the limit" configuration for the inverter's minimum input voltage.	<ul style="list-style-type: none"> • Check the input voltage on the inverter. - If it does not exceed Vstart, check for the presence of sufficient irradiation and the correct composition of the system. - If it exceeds Vstart, contact customer assistance

- Error code - Error message - Warning	Name of Alarm and Cause	Solution
<ul style="list-style-type: none"> - W003 - Grid Fail -  Yellow LED 	<p>Parameters of grid voltage outside range: This error signal occurs when during the inverter's normal operation the grid parameters exceed the limits set by the operator:</p> <ul style="list-style-type: none"> - Grid voltage absent (after the signal the inverter goes to "Missing Grid") - Unstable grid voltage (values too low or too high) - Unstable grid frequency 	<ul style="list-style-type: none"> • Check the grid voltage on the inverter. - Should it be absent, check for absence of grid voltage on the supply point. - If, on the other hand, the voltage tends to rise (when the inverter is connected) there is high line or grid impedance. • Check the grid voltage also on the supply. - If it is high, it means that there is high grid impedance. In this case, ask the operator to adjust the grid voltage. If the operator authorises a change to the inverter's parameters, agree the new limits with customer assistance - If the voltage at the point of supply is much lower than that measured on the inverter, it is necessary to adjust the line (inverter-contactor). - If the voltage and the grid frequency come back within the limits (also when the inverter is connected to the grid), contact customer assistance
<ul style="list-style-type: none"> - W004 - Grid OV -  Yellow LED 	<p>Grid overvoltage: This error signal occurs when during the inverter's normal operation the grid voltage exceeds the maximum limit set by the operator.</p>	<ul style="list-style-type: none"> • Check the grid voltage on the inverter. If the voltage tends to rise (when the inverter is connected), there is a problem of high line or grid impedance. • Check the grid voltage also on the supply. - If it is high, it means that there is high grid impedance. In this case, ask the operator to adjust the grid voltage. If the operator authorises a change to the inverter's parameters, agree the new limits with customer assistance - If the voltage at the point of supply is much lower than that measured on the inverter, it is necessary to adjust the line (inverter-contactor). - If the voltage and the grid frequency come back within the limits (also when the inverter is connected to the grid), contact customer assistance
<ul style="list-style-type: none"> - W005 - Grid UV -  Yellow LED 	<p>Grid undervoltage: This error signal occurs when during the inverter's normal operation the grid voltage exceeds the minimum limit set by the operator.</p>	<ul style="list-style-type: none"> • Check the grid voltage on the inverter. • Check the grid voltage also on the supply. - If it is high, it means that there is high grid impedance. In this case, ask the operator to adjust the grid voltage. If the operator authorises a change to the inverter's parameters, agree the new limits with customer assistance - If the voltage at the point of supply is much lower than that measured on the inverter, it is necessary to adjust the line (inverter-contactor). - If the voltage and the grid frequency come back within the limits (also when the inverter is connected to the grid), contact customer assistance
<ul style="list-style-type: none"> - W006 - Grid OF -  Yellow LED 	<p>Grid over-frequency: This error signal occurs when during the inverter's normal operation the grid frequency exceeds the maximum limit set by the operator.</p>	<ul style="list-style-type: none"> • Check the grid frequency in the inverter. • Check the grid frequency also on the supply: - If the voltage and the grid frequency come back within the limits (also when the inverter is connected to the grid), contact customer assistance
<ul style="list-style-type: none"> - W007 - Grid UF -  Yellow LED 	<p>Grid under-frequency: This error signal occurs when during the inverter's normal operation the grid frequency exceeds the minimum limit set by the operator.</p>	<ul style="list-style-type: none"> • Check the grid frequency in the inverter. • Check the grid frequency also on the supply: - If the voltage and the grid frequency come back within the limits (also when the inverter is connected to the grid), contact customer assistance
<ul style="list-style-type: none"> - W010 * - Fan Fail -  Flashing yellow LED *not visualised on display 	<p>Fan Fail: This error occurs when there is a malfunction in the fan/fans inside the inverter.</p>	<ul style="list-style-type: none"> • Error inside the inverter and cannot be checked externally. - If the alarm repeats persistently, contact customer assistance.
<ul style="list-style-type: none"> - W011 - Bulk UV -  Yellow LED 	<p>Low "Bulk" voltage (DC-DC circuit): The alarm (which is a warning and not an error) is generated when the voltage at the heads of the bulk capacitors does not reach the threshold for the operation of the inverter (internal unchangeable threshold).</p>	<ul style="list-style-type: none"> • Raise the value of the activation voltage (Vstart) so as to have sufficient power from the PV generator at the time of the inverter's grid connection. • Check the input voltage on the inverter. - If it does not exceed Vstart, check for the presence of sufficient irradiation and the correct composition of the system. - If it exceeds Vstart, contact customer assistance.



- Error code - Error message - Warning	Name of Alarm and Cause	Solution
- W012 * - Batt. Low -  Flashing yellow LED *not visualised on display	Battery Low: The inverter has detected a backup battery voltage that is too low.	<ul style="list-style-type: none"> • Check that the date/time are set correctly and, if they are not, set them. • Subsequently arrange to completely switch off the inverter (on both AC and DC) and wait a few minutes. • Finally, restart the inverter and check whether the date/time are now correctly set or whether they have reset to 01/01/2000. In this case replace the battery with the inverter completely switched off (isolate AC and DC side) being careful to maintain the polarity
- W013 * - Clock Fail -  Flashing yellow LED *not visualised on display	Clock Fail: The alarm occurs when there is a difference of more than 1 minute in the time shown on the display or via the advanced configuration software compared to the internal time of the microprocessors and indicates a malfunction of the clock circuit.	<ul style="list-style-type: none"> • Error inside the inverter and cannot be checked externally. - If the alarm repeats persistently, contact customer assistance.
- W015 - Island Detect. -  Yellow LED	Disconnection due to Anti-Islanding: The inverter has been improperly connected to an island grid.	<ul style="list-style-type: none"> • Check that the grid to which the inverter is connected is not an island grid. - If the grid to which the inverter is connected is an island grid, switch the inverter off and then on again: if the problem persists, contact customer assistance.
- W017* - String Err. -  Flashing yellow LED * (only for models with monitored string fuses)	Error recorded in measuring string currents: Damaged string protection fuse(s)	<ul style="list-style-type: none"> • Check with a multimeter the state of the fuses (positioned on the fuse boards). - If one or more fuses is open, arrange to replace them and check that the input current on the string(s) does not exceed the rating of the fuses (should parallel strings have been made outside the inverter). - If there are no damaged string fuses and the inverter continues to show the alarm message check whether the settings to be made via the Aurora Manager software are correct (presence or absence of one or more input strings).
- W018 * - SPD DC Err -  Flashing yellow LED * (only for models with monitored SPD)	Intervention of overvoltage surge arresters on DC side: Overvoltage surge arresters situated on the DC side are damaged.	<ul style="list-style-type: none"> • Observe the inspection window on each surge arrester (DC side). If it is red, the surge arrester is damaged and the cartridge must be replaced. - If the alarm status persists, even if all the surge arresters have a green inspection window, contact customer assistance.
- W019 * - SPD AC Err -  Flashing yellow LED * (only for models with monitored SPD)	Intervention of overvoltage surge arresters on AC side: Overvoltage surge arresters situated on the AC side are damaged.	<ul style="list-style-type: none"> • Observe the inspection window on each surge arrester (AC side). If it is red, the surge arrester is damaged and the cartridge must be replaced. - If the alarm status persists, even if all the surge arresters have a green inspection window, contact customer assistance.
W021 - P-reductionStart -  No LED *not visualised on display	Activation of reduction in power: Indicates that one of the power limitations described in the paragraph "Power limitation messages" has been triggered.	<ul style="list-style-type: none"> • Check which power limitation code is active and, on the basis of that, carry out the necessary checks that might relate to various factors including: <ul style="list-style-type: none"> - settings by the user - high grid frequency - high grid voltage - anti-islanding - low grid voltage - high internal temperature - high input voltage
- W022 * - Reactive power mode changed -  No LED *not visualised on display	Variation in means of managing reactive power: Variation in the means of managing reactive power; this change can be made through the display or advanced configuration software.	The variation in the means of managing reactive power is done directly by the customer/installer and is not an error. The information is only saved on the historic record of the events memorised by the inverter
- W023 * - date/time changed -  No LED *not visualised on display	Variation in the inverter's date and time: Variation of the inverter's date and time; this change can be made through the display or advanced configuration software.	<ul style="list-style-type: none"> • The variation in the inverter's date and time is done directly by the customer/installer and is not an error. The information is only saved on the historic record of the events memorised by the inverter



- Error code - Error message - Warning	Name of Alarm and Cause	Solution
- W024 * - Energy data reset - ⊗ No LED *not visualised on display	Zeroing of the statistical energy data memorised in the EEPROM: Reset of the energy data saved in the inverter; this operation can be handled through the display or advanced configuration software.	The zeroing of the partial energy values memorised by the inverter is done directly by the customer/installer and is not an error. The information is only saved on the historic record of the events memorised by the inverter • The warning may also occur when the Memory Card on which the production statistics are saved is replaced
W025 - P-reductionEnd - ⊗ No LED *not visualised on display	Deactivation of reduction in power: Indicates that the inverter has come out of one of the power limitation states described in the paragraph "Power limitation messages".	This type of warning does not need any check
- W026 * - AFDD user reset - ⊗ No LED *not visualised on display	Reset of the Arc Fault error: Manual reset of the Arc Fault error; this operation can be made through the display or advanced configuration software.	• The reset of the Arc Fault error is done directly by the customer/installer and is not an error. The information is only saved on the historic record of the events memorised by the inverter
- W027 * - Latch-Manual reset - ⊗ No LED *not visualised on display	Resetting of the Latch alarm conditions: Manual reset of the Latch alarm conditions; this operation can be made through the display or advanced configuration software.	• The reset of the Latch alarm conditions is done directly by the customer/installer and is not an error. The information is only saved on the historic record of the events memorised by the inverter
- W030 - Energy Meter ERROR * - ⊗ No LED * text "METER COM. ERR." shown on the display in the general information (cyclical screens)	METER device communication problem: Error detected on the RS485 serial communication line between the inverter and the energy meter (METER).	• Check the serial communication line connections between the inverter and the METER. Particularly check the signal correspondence, the correct installation of the conductors and that there are no breaks in the cables. • Faulty communication card (Comm. card) • Error inside the inverter and cannot be checked externally. - If the problem persists (once the inverter has been switched off and back on again), contact customer assistance.
- W031 - BMS fault - ⊗ No LED * text "BMS COM. ERR." shown on the display in the general information (cyclical screens)	Battery unit communication problem: Error detected on the internal communication line between the inverter unit and the battery unit.	• Check the serial communication line connections between the inverter unit and the battery unit. Particularly check the connectors have been installed correctly and that there are no breaks in the cables connecting the two units. • Error inside the inverter and cannot be checked externally. - If the problem persists (once the inverter has been switched off and back on again), contact customer assistance.
- W036 - Batt. 1 - W - ⊗ No LED	Problem inside battery unit 1: Problem inside battery unit. This condition can be transitory with automatic reset at the end of the alarm situation	• Error inside the inverter and cannot be checked externally. - If the problem persists (once the inverter has been switched off and back on again), contact customer assistance.
- W037 - Batt. 1 - F1 - ⊗ No LED	Error inside battery unit 1: Problem inside battery unit. This condition can be transitory with automatic reset at the end of the alarm situation	• Error inside the inverter and cannot be checked externally. - If the problem persists (once the inverter has been switched off and back on again), contact customer assistance.
- W039 - Batt. 2 - W - ⊗ No LED	Problem inside battery unit 2: Problem inside battery unit. This condition can be transitory with automatic reset at the end of the alarm situation	• Error inside the inverter and cannot be checked externally. - If the problem persists (once the inverter has been switched off and back on again), contact customer assistance.
- W040 - Batt. 2 - F1 - ⊗ No LED	Error inside battery unit 2: Problem inside battery unit. This condition can be transitory with automatic reset at the end of the alarm situation	• Error inside the inverter and cannot be checked externally. - If the problem persists (once the inverter has been switched off and back on again), contact customer assistance.
- W042 - Batt. 3 - W - ⊗ No LED	Problem inside battery unit 3: Problem inside battery unit. This condition can be transitory with automatic reset at the end of the alarm situation	• Error inside the inverter and cannot be checked externally. - If the problem persists (once the inverter has been switched off and back on again), contact customer assistance.
- W043 - Batt. 3 - F1 - ⊗ No LED	Error inside battery unit 3: Problem inside battery unit. This condition can be transitory with automatic reset at the end of the alarm situation	• Error inside the inverter and cannot be checked externally. - If the problem persists (once the inverter has been switched off and back on again), contact customer assistance.
- W045 - Sys disconnected - ● Yellow LED	Disconnection of system from grid: Warning of disconnection of system from electrical grid (no DC input voltage) because of dead battery pack or no demand from domestic loads	• Check that, when the warning occurs, the battery pack is dead and/or there have been no energy demands from domestic loads for more than 10 minutes.



- Error code - Error message - Warning	Name of Alarm and Cause	Solution
- W046 - Grid conn. fault - ● Yellow LED	Connection to the grid unsuccessful The alarm is logged when a Missing grid or Input UV error occurs or due to the manual disconnection of the inverter during the grid connection sequence.	<ul style="list-style-type: none"> Once the error occurs, the inverter tries to return to normal operation. If the problem persists after a number of attempts to connect the inverter, switch the inverter off and then on again. If the problem persists (once the inverter has been switched off and back on again), contact customer assistance.
- W047 - Update Incomplete - ● Yellow LED	FW update method unsuccessful The alarm occurs when a firmware update has not been completed.	<ul style="list-style-type: none"> Complete any pending firmware updates. If the problem persists once the firmware updates have been completed, switch the inverter off and on again. If the problem persists (once the inverter has been switched off and back on again), contact customer assistance.
- W048 - Periodic GridOff - ● Yellow LED	Automatic disconnection from the grid due to time limit: If the inverter exceeds the set grid connection time limit set by the grid standard, it will automatically have to carry out a disconnection and reconnection to the grid to carry out the Riso test.	<ul style="list-style-type: none"> The presence of this alarm is not an error as the automatic disconnection is prescribed by safety regulations. If the inverter disconnects in a shorter time than expected, contact customer assistance.
- W049 * - Global-Settings Event - ⊗ No LED *not visualised on display	Variation of the grid standard Variation of the inverter's grid standard; this change can be made through the display or advanced configuration software.	<ul style="list-style-type: none"> The variation in the inverter's grid standard is done directly by the customer/installer and is not an error. The information is only saved on the historic record of the events memorised by the inverter
- W051 - Exit from Stand Alone connection - ● Yellow LED	Exit from Stand-alone mode: The alarm is logged when the "Stand Alone" mode is deactivated or the inverter reconnects to the grid (this can only be seen if the Stand Alone accessory board has been installed).	<ul style="list-style-type: none"> Deactivation of the Stand Alone mode is done directly by the customer/installer or automatically by the inverter and is not an error.
- W053 - SOH Low - ⊗ Flashing yellow LED * text "Bat. Warn-SOH_L" shown on the display in the general information (cyclical screens)	State of health (SOH) of battery pack low: Indicates that the SOH level of the battery pack (during normal operation) is close to the threshold below which it cannot be used. The alarm is displayed for SOH values between 51 and 60%.	<ul style="list-style-type: none"> Indicates that the useful life of the battery is about to end as with SOH values of below 50% it should be replaced.
- W054 - SOH Low (Fault) - ⊗ Flashing yellow LED * text "Bat. Fault-SOH_L" shown on the display in the general information (cyclical screens)	Battery pack blocked through low state of health (SOH): Indicates that the SOH level of the battery pack (during normal operation) is below the threshold for use. The alarm is displayed for SOH values below 50%.	<ul style="list-style-type: none"> Indicates that the useful life of the battery is over and it must be replaced.
- W055 - Battery Low (0%) - ⊗ No Led* text "SOC LOW" shown on the display in general information (cyclical screens)	State of charge (SOC) of battery pack low: Indicates that the battery is completely dead.	<ul style="list-style-type: none"> Where permitted by the regulations of the country where it is installed, it is advisable to force the battery to recharge using the electrical grid (charge in AC). Otherwise it is necessary to have good energy production and low absorption of domestic loads to carry out the recharging of the battery (charge in DC).
- W056 - Power Engage - ● Yellow LED * "CHECK BATT CABLE" is displayed in the general information (cyclical screens)	Problem with battery pack (power) connection cables: Error detected on the power cables between the inverter unit and the battery unit.	<ul style="list-style-type: none"> Check the power line connections between the inverter unit and the battery unit. Particularly check the connectors have been installed correctly and that there are no breaks in the cables connecting the two units. Error inside the inverter and cannot be checked externally. If the problem persists (once the inverter has been switched off and back on again), contact customer assistance.
- W058 - System Frozen - ● Yellow LED	Converter in locked state: The converter lock state is connected to an installation phase in which the starts-up and grid connection conditions are not yet present.	<ul style="list-style-type: none"> Complete the commissioning phase of the inverter. If the problem persists (once the commissioning phase has been completed and the inverter has been switched off and back on again), contact customer assistance.



- Error code - Error message - Warning	Name of Alarm and Cause	Solution
- W059 - Output power Overload - ● Yellow LED	Overload on Stand-alone output: The alarm occurs when there is an excessive request for power by the grid with the inverter in "Stand Alone" mode (this can only be seen if the Stand Alone accessory board has been installed).	<ul style="list-style-type: none"> • Disconnect one or more loads from the Stand Alone output. - If the problem persists (once all loads have been disconnected and the inverter has been switched off and back on again), contact customer assistance.
- W060 - COMMISSIONING - SOH test - Warning - ⊗ No LED * text "Bat. Warn-SOH_L" shown on the display in the general information (cyclical screens)	State of health (SOH) of battery pack low: Indicates that the SOH level of the battery pack (during system commissioning) is close to the threshold below which it cannot be used. The alarm is displayed for SOH values between 51 and 60%.	<ul style="list-style-type: none"> • Indicates that the useful life of the battery is about to end as with SOH values of below 50% it should be replaced.
- W061 - COMMISSIONING - SOH test - Fault - ⊗ No LED * text "Bat. Fault-SOH_L" shown on the display in the general information (cyclical screens)	Battery pack blocked through low state of health (SOH): Indicates that the SOH level of the battery pack (during system commissioning) is below the threshold for use. The alarm is displayed for SOH values below 50%.	<ul style="list-style-type: none"> • Indicates that the useful life of the battery is over and it must be replaced.
- W062 - BMS Shutdown err - ⊗ No LED	Disconnection of the battery did not occur: Impossible to disconnect the battery pack (via the system's internal devices) following a command (automatic or manual).	<ul style="list-style-type: none"> • Error inside the inverter and cannot be checked externally. - If the problem persists (once the inverter has been switched off and back on again), contact customer assistance.
- W063 - Force Grid Disconnection for SA Request - ● Yellow LED	Forced disconnection from grid: The inverter disconnects from the grid following a command input in stand-alone mode	<ul style="list-style-type: none"> • This warning is not of an error but is a message informing that the inverter has been forced to disconnect from the grid to go into stand-alone mode
W064 - Battery Firmware Update Failed - ⊗ Flashing yellow LED * "BMS FW UPDT ERR." shown on the display in general information (cyclical screens)	Update of battery unit firmware failed: Indicates that the update of battery unit firmware has failed.	<ul style="list-style-type: none"> • Redo the battery unit firmware update procedure. If the error warning is shown again contact customer assistance to check the new firmware's compatibility.
- E001 - Input OC - ● Yellow LED	Input over-current (photovoltaic generator): The alarm occurs when the inverter's input current exceeds the inverter's threshold for maximum input current.	<ul style="list-style-type: none"> • Check whether the composition of the PV generator enables input current which exceeds the maximum threshold allowed by the inverter and that the configuration of the inputs (independent or in parallel) is carried out correctly. - If both checks are positive, contact customer assistance.
- E002 - Input OV - ● Yellow LED	Input overvoltage (photovoltaic generator): The alarm is generated when the input voltage (from the PV generator) exceeds the inverter's threshold of maximum input voltage. The alarm is triggered before reaching the absolute threshold beyond which the inverter will be damaged. When the inverter's input voltage exceeds the Over Voltage threshold, the inverter will not start up due to the generation of the alarm.	<ul style="list-style-type: none"> • It is necessary to measure the input voltage inside the inverter with a voltmeter. - If it is higher than the maximum voltage of the operating range, the alarm is genuine and it is necessary to check the configuration of the PV generator. If the voltage has also exceeded the maximum input threshold the inverter could be damaged. - If it is lower than the maximum voltage of the operating range, the alarm is caused by an internal malfunction and it is necessary to contact customer assistance.
- E003 - No Parameters - ● Yellow LED	DSP initialisation error: The main microcontroller is unable to correctly initialize the two DSPs (booster stage and inverter stage). The error is caused by communication problems on the inverter's internal bus.	<ul style="list-style-type: none"> • Error inside the inverter and cannot be checked externally. - If the problem persists (once the inverter has been switched off and back on again), contact customer assistance.













- Error code - Error message - Warning	Name of Alarm and Cause	Solution
- E004 - Bulk OV - Yellow LED	“Bulk” over-voltage (DC-DC circuit): Error inside the inverter. The alarm is raised when the voltage at the heads of the bulk capacitors exceeds the Over Voltage threshold (internal unchangeable threshold).	<ul style="list-style-type: none"> The alarm may be triggered by causes external to the inverter: <ul style="list-style-type: none"> An excessive input voltage can be recorded as a condition for bulk over voltage. In this case it is advisable to check the inverter's input voltage and should this value be close to the input OV threshold, review the configuration of the photovoltaic generator. Excessive grid voltage could cause the bulk voltage to rise in uncontrolled fashion with a consequent protection intervention and hence generation of the alarm. In these cases the alarm is transitory and the inverter automatically restarts The alarm may be triggered by causes inside the inverter and in this case it is necessary to contact customer assistance.
- E005 - Comm.Error - Yellow LED	Communication error inside the inverter: The alarm occurs when there are communication problems between the control devices inside the inverter.	<ul style="list-style-type: none"> Error inside the inverter and cannot be checked externally. If the problem persists (once the inverter has been switched off and back on again), contact customer assistance.
- E006 - Output OC - Yellow LED	Output overcurrent: The alarm occurs when the inverter's output current exceeds the inverter's threshold for maximum output current.	<ul style="list-style-type: none"> Error inside the inverter and cannot be checked externally. If the problem persists (once the inverter has been switched off and back on again), contact customer assistance.
- E007 - IGBT Sat - Yellow LED	Saturation recorded on the IGBT components: The alarm appears when one of the active devices of the inverter is in saturation state.	Once the error appears, the inverter attempts to resume normal operation. <ul style="list-style-type: none"> Should the error occur sporadically, it may be caused by a brusque transition of the grid voltage or of the input voltage, but is not due to a malfunction by the inverter. If the error is connected to an internal fault, it will continue to appear and so it is necessary to contact customer assistance.
- E009 - Internal error - Yellow LED	Error inside the inverter: Error inside the inverter	<ul style="list-style-type: none"> Error inside the inverter and cannot be checked externally. If the problem persists (once the inverter has been switched off and back on again), contact customer assistance.
- E010 - Bulk Low - Yellow LED	Low “Bulk” voltage (DC-DC circuit): The alarm can be caused by causes external to the inverter: a reduced input voltage on the inverter (just above the activation voltage) but which is not accompanied by a sufficient availability of power from the photovoltaic generator (typical condition of the stages with limited irradiation)	<ul style="list-style-type: none"> If the error signal occurs sporadically, it may be due to causes external to the inverter (limited irradiation and so limited power availability from the PV generator). If the problem occurs systematically even in conditions of high irradiation and with input voltage which is significantly higher than the activation voltage, contact customer assistance.
- E011 - Ramp Fail - Yellow LED	Long wait for “Booster” regime to start: Error internal to inverter relating to start up time for DC-DC circuit regime (Booster)	<ul style="list-style-type: none"> Error inside the inverter and cannot be checked externally. If the problem persists (once the inverter has been switched off and back on again), contact customer assistance.
- E012 - DcDc Fail - Yellow LED	Error in the “Booster” circuit (DC-DC side) recorded by the “Inverter” circuit (DC-AC side): Error inside the inverter regarding the operation of the DC-DC circuit part (Booster).	<ul style="list-style-type: none"> Error inside the inverter and cannot be checked externally. If the problem persists (once the inverter has been switched off and back on again), contact customer assistance.
- E013 - Wrong Mode - Yellow LED	Incorrect configuration of inputs (set in parallel rather than independent): The alarm is generated solely when the inverter is configured with parallel inputs. In this particular configuration the inverter checks the input voltage of each of the two channels and if the two voltages differ by more than 20Vdc, the alarm is raised .	<ul style="list-style-type: none"> Check that the setting of the "IN MODE" switch is specifically set to "PAR" and that the bridges between the two input channels have been included. If the configuration of the inverter is correct, check that the input strings have the usual number of standard panels of the usual brand and with the same inclination/orientation. If both the configuration of the inverter and the characteristics of the PV generator conform with the specifications, contact customer assistance.
- E014 - Over Temp. - Yellow LED	Excessive temperature inside the inverter: External temperature over 60°C. This parameter also depends on the power which the inverter must supply since the measurement of temperatures is done internally and is influenced by the heat dissipated by the components of the inverter itself	<ul style="list-style-type: none"> Check that the inverter is not exposed to direct sunlight. Wait for the temperatures to which the inverter is exposed to return to the operating range and for the inverter to cool down. If the problem persists (once the ambient temperature has returned to within the range), contact customer assistance. You must remember to wait for the time necessary to allow the inverter to cool down.

















- Error code - Error message - Warning	Name of Alarm and Cause	Solution
- E015 - Bulk Cap Fail - ● Yellow LED	Breakdown recorded on the “Bulk” capacitor: Error inside the inverter regarding a problem in the bulk capacitors.	<ul style="list-style-type: none"> • Error inside the inverter and cannot be checked externally. - If the problem persists (once the inverter has been switched off and back on again), contact customer assistance.
- E016 - Inverter Fail - ● Yellow LED	Error in the “Inverter” circuit (DC-AC side) recorded by the “Booster” circuit (DC-DC side): The alarm is generated when a problem is detected in the inverter circuit part (DC/AC).	<ul style="list-style-type: none"> • Error inside the inverter and cannot be checked externally. - If the problem persists (once the inverter has been switched off and back on again), contact customer assistance.
- E017 - Start Timeout - ● Yellow LED	Long wait for “Inverter” regime to start up: Error internal to inverter relating to start-up time for the DC-AC circuit regime (Inverter) The alarm can be caused by causes external to the inverter: a reduced input voltage on the inverter (just above the activation voltage) but which is not accompanied by a sufficient availability of power from the photovoltaic generator (typical condition of the stages with limited irradiation)	<ul style="list-style-type: none"> - If the error signal occurs sporadically, it may be due to causes external to the inverter (limited irradiation and so limited power availability from the PV generator). - If the problem occurs systematically even in conditions of high irradiation and with input voltage which is significantly higher than the activation voltage, contact customer assistance.
- E018 - Ground Fault - ● Red LED	High leakage current measured on the DC side (photovoltaic generator): The alarm is generated when, during normal operation of the inverter, a leakage current to ground is detected in the DC section of the system. It is also possible that the inverter generates the alarm E018 message also due to AC leakage currents connected to the capacitive nature of the photovoltaic generator compared to ground.	<ul style="list-style-type: none"> • Measure the isolation resistance using a megohmmeter positioned in the photovoltaic array (positive terminal short-circuited at the negative pole) compared to ground. The measurement is strongly influenced by the environmental conditions, so must be made under the same conditions in which the error occurred. - If the value measured is lower than 1 megaohm, a check must be carried out by a technician/installer on the photovoltaic generator to identify and eliminate the problem. - If the value measured is higher than 1 megaohm and the error signal persists, contact customer assistance.
- E019 - leak sense.fail - ● Yellow LED	Failure of test on sensor to measure the leakage current (DC side): Before connecting to the grid the inverter runs a self-test regarding the sensor for the leakage current. The test is carried out by “forcing”, in the sensor of the leakage current, a current with a known value: the microprocessor compares the value read with the known value. The error is generated if the comparison between the read value and the known value during the test does not fall within the allowed tolerance.	<ul style="list-style-type: none"> • Error inside the inverter and cannot be checked externally. By its nature, the alarm only occurs prior to connection to the grid - If the problem persists (once the inverter has been switched off and back on again), contact customer assistance.
- E020 - Self Test Error 1 - ● Yellow LED	Failure of the test on the relay of the “Booster” (DC-DC circuit): Before connecting to the grid, the inverter carries out some internal tests. One of these tests concerns the correct operation of the booster relay. The test is carried out by “forcing” the switching of the relay and checking its operation. The error is generated if a problem is found in actioning the relay.	<ul style="list-style-type: none"> • Error inside the inverter and cannot be checked externally. By its nature, the alarm only occurs prior to connection to the grid - If the problem persists (once the inverter has been switched off and back on again), contact customer assistance.
- E021 - Self Test Error 2 - ● Yellow LED	Failure of the test on the inverter's relay (DC-AC circuit): Before connecting to the grid, the inverter carries out some internal tests. One of these tests concerns the correct operation of the inverter relay. The test is carried out by “forcing” the switching of the relay and checking its operation. The error is generated if a problem is found in actioning the relay.	<ul style="list-style-type: none"> • Error inside the inverter and cannot be checked externally. By its nature, the alarm only occurs prior to connection to the grid - If the problem persists (once the inverter has been switched off and back on again), contact customer assistance.



- Error code - Error message - Warning	Name of Alarm and Cause	Solution
- E022 - Self Test Error 4 -  Yellow LED	Timeout of the tests undertaken on the relays inside the inverter: Execution time for the self-test carried out on the relay of the DC_AC (inverter) circuit too high. It may indicate a problem connected to the aforementioned relays	<ul style="list-style-type: none"> • Error inside the inverter and cannot be checked externally. - If the problem persists (once the inverter has been switched off and back on again), contact customer assistance.
- E023 - DC in error -  Yellow LED	Feeding of direct current to grid outside of range: The error is generated if the direct component of the current supplied to the grid exceeds the threshold of 0.5% of the rated operating current. In any case, the inverter does not stop because of the E023 error, but tries to connect to the grid again. The sporadic repetition of the error is a sign of serious grid distortions or sharp irradiation changes, while systematic repetition of the error signal will indicate a breakdown on the inverter	Once the error appears, the inverter attempts to resume normal operation. <ul style="list-style-type: none"> - Should the error occur sporadically, it may be caused by a brusque transition of the grid voltage or of the input voltage, but is not due to a malfunction by the inverter. - If the error is connected to an internal fault, it will continue to appear and so it is necessary to contact customer assistance.
- E024 - Internal error -  Yellow LED	Error inside the inverter: Error inside the inverter	<ul style="list-style-type: none"> • Error inside the inverter and cannot be checked externally. - If the problem persists (once the inverter has been switched off and back on again), contact customer assistance.
- E025* - Riso Low -  Red LED *not visualised on display	Low value of isolation resistance: Before connecting to the grid the inverter measures the isolation resistance of the PV generator compared to ground. Should the measurement of the isolation resistance be below 1Mohm, the inverter does not connect to the grid and shows the "Riso Low" error. The causes may be: <ul style="list-style-type: none"> - Damaged PV panel(s). - Junction box(es) of the panels not correctly sealed, so as to permit infiltration by water and/or humidity; - Problems in connections between panels (not perfectly fit); - Poor quality of cable joints; - Presence in the DC section of unsuitable or damaged overvoltage surge arresters outside the inverter (reduced ignition voltage compared to the characteristics of the strings of the PV generator); - Presence of humidity inside any junction box 	<ul style="list-style-type: none"> • Measure the isolation resistance using a megohmmeter positioned in the photovoltaic array (positive terminal short-circuited at the negative pole) compared to ground. The measurement is strongly influenced by the environmental conditions, so must be made under the same conditions in which the error occurred. - If the value measured is lower than 1 megaohm, a check must be carried out by a technician/installer on the photovoltaic generator to identify and eliminate the problem. - If the value measured is higher than 1 megaohm and the error signal persists, contact customer assistance.
 - E026 - Vref Error -  Yellow LED	Internal reference voltage outside of range: Wrong measurement of reference voltage inside inverter	<ul style="list-style-type: none"> • Error inside the inverter and cannot be checked externally. - If the problem persists (once the inverter has been switched off and back on again), contact customer assistance.
- E027 - Error Meas V -  Yellow LED	Grid voltage outside of range: Error in the internal measurement of grid voltage (set by law) to have a redundant measurement (2 measurements on the same parameter made by two different circuits)	<ul style="list-style-type: none"> • Error inside the inverter and cannot be checked externally. - If the problem persists (once the inverter has been switched off and back on again), contact customer assistance.
- E028 - Error Meas F -  Yellow LED	Grid frequency outside of range: Error in the internal measurement of the grid frequency (imposed by regulations) to have a measurement redundancy (2 measurements on the same parameter carried out by two different circuits).	<ul style="list-style-type: none"> • Error inside the inverter and cannot be checked externally. - If the problem persists (once the inverter has been switched off and back on again), contact customer assistance.
- E029 - Mid Bulk OV -  Yellow LED	Internal overvoltage on the measurement of the "Mid bulk": Error inside the inverter (only triphase models)	<ul style="list-style-type: none"> • Error inside the inverter and cannot be checked externally. - If the problem persists (once the inverter has been switched off and back on again), contact customer assistance.
- E030 - Error Meas Ileak -  Yellow LED	High leakage current (DC side): <ul style="list-style-type: none"> - Error on the internal measurement (performed when the inverter is connected to the grid) of the DC side (PV generator) leakage current with respect to ground (required by regulations) to have a measurement redundancy (2 measurements of the same parameter carried out by two independent circuits) 	<ul style="list-style-type: none"> • Error inside the inverter and cannot be checked externally. - If the problem persists (once the inverter has been switched off and back on again), contact customer assistance.

- Error code - Error message - Warning	Name of Alarm and Cause	Solution
- E031 - Error Read V - Yellow LED	Output relay damaged: Measurement of internal voltage on heads of the output relay outside of range. There is too great a difference in voltage between the input and output of the grid connection relay.	<ul style="list-style-type: none"> • Error inside the inverter and cannot be checked externally. - If the problem persists (once the inverter has been switched off and back on again), contact customer assistance.
- E032 - Error Read I - Yellow LED	Imbalanced output currents: Measurement of the unbalance in the output voltage (made across the three phases) outside of range (only in three-phase models)	<ul style="list-style-type: none"> • Error inside the inverter and cannot be checked externally. - If the problem persists (once the inverter has been switched off and back on again), contact customer assistance.
- E033 - UTH - Yellow LED	Low ambient temperature: Temperature outside the inverter below -25°C	<ul style="list-style-type: none"> • Wait for the temperatures to which the inverter is exposed to return to the operating range. - If the problem persists, contact customer assistance. You must remember to wait for the time necessary to allow the inverter to warm up.
- E034 - Interlock fail - Yellow LED	“IGBT” circuitry not ready: Error inside the inverter	<ul style="list-style-type: none"> • Error inside the inverter and cannot be checked externally. - If the problem persists (once the inverter has been switched off and back on again), contact customer assistance.
- E035* - Remote Off - Yellow LED *not visualised on display	Inverter awaiting “remote ON” command: The inverter has been switched off remotely (remote OFF) and remains in waiting state for the signal that will switch it on again (remote ON).	<ul style="list-style-type: none"> • Switch the inverter back on remotely. If the unit does not switch on, disable the remote on/off function and switch the equipment off completely and then switch it on again. - If the problem persists (once the Remote ON/OFF function has been reactivated), contact customer assistance.
- E036 - Vout Avg error - Yellow LED	Average of the measurements of grid voltage outside of range: The average value of the grid voltage (sampled every 10 minutes) does not fall within the permitted ranges. The grid voltage in the point connected to the inverter is too high. This may be caused by a grid impedance that is too high. In the final stage of the timeout, the inverter limits the power to check whether the grid voltage has stabilised into regular parameters. If this does not happen, the inverter disconnects from the grid	<ul style="list-style-type: none"> • Check the grid voltage in the connection point to the inverter. - If the grid voltage differs from the range due to the conditions of the distribution grid, ask the operator to adjust the grid voltage. If the operator authorises a change to the inverter's parameters, agree the new limits with customer assistance.
- E037 - Riso Low - Red LED	Low value of the isolation resistance (only with the “Amorphous” mode activated): This error can appear only if the “Amorphous” mode is enabled. This function is enabled only in inverters equipped with grounding kit and is used to monitor the voltage at the ends of the grounding resistor. The error appears when the voltage at the ends of the resistor connected between ground and pole of the photovoltaic generator exceeds 30V for more than 30 minutes or 120V for more than one second.	<ul style="list-style-type: none"> • Check for the presence and correct contact between the two terminals of the grounding resistance installed inside the inverter • Measure the isolation resistance using a megohmmeter positioned in the photovoltaic array (positive terminal short-circuited at the negative pole) compared to ground. The measurement is strongly influenced by the environmental conditions, so must be made under the same conditions in which the error occurred. - If the value measured is lower than 1 megaohm, a check must be carried out by a technician/installer on the photovoltaic generator to identify and eliminate the problem. - If the value measured is higher than 1 megaohm and the error signal persists, contact customer assistance.
E046 - String self test fail - No LED	Error during the automatic check of the string voltages (only in models with the “fuse-control” board): In some inverter models it is possible to carry out the check test of the polarity of the strings connected to the input (e.g.:TRIO-20.0/27.6kW). This error signal occurs when, during the test stage, an inverted string is recorded	<ul style="list-style-type: none"> • Section the inverter and check the polarity of the string(s) which the inverter has recorded as inverted. - Once all the strings have been correctly connected, activate the system once again; the inverter will once again check the correct polarity of the string inputs at the end of which it will carry out the checks for the grid connection. - If the problem persists (once the inverter has been switched off and back on again), contact customer assistance.
E049 - AC FF Error - Yellow LED	Error in the “AC feed-forward” circuit: Error inside the inverter	<ul style="list-style-type: none"> • Error inside the inverter and cannot be checked externally. - If the problem persists (once the inverter has been switched off and back on again), contact customer assistance.
E050 - AFDD Activated - Yellow LED	Arc Fault protection activated: Possible photovoltaic arc detected on the DC side.	<ul style="list-style-type: none"> • If it is the first time this problem has occurred, press the ESC button for 5 seconds and wait for the unit to restart. - If the problem persists (once the inverter has been switched off and back on again), contact customer assistance.
E051 - Safety mem. Fault - Yellow LED	Error inside the inverter.	<ul style="list-style-type: none"> • Error inside the inverter and cannot be checked externally. - If the problem persists (once the inverter has been switched off and back on again), contact customer assistance.



- Error code - Error message - Warning	Name of Alarm and Cause	Solution
E053 - AFDD Fault -  Yellow LED	Arc Fault board autotest failed: Problem detected during the AFDD board autotest phase.	<ul style="list-style-type: none"> • Error inside the inverter and cannot be checked externally. - If the problem persists (once the inverter has been switched off and back on again), contact customer assistance.
E054 - AFDD comm. Fault -  Yellow LED	Arc Fault board communication error: Error on the RS485 serial communication detected between the inverter and the AFDD board.	<ul style="list-style-type: none"> • Error inside the inverter and cannot be checked externally. - If the problem persists (once the inverter has been switched off and back on again), contact customer assistance.
E055 - AFDD wrong conf. -  Yellow LED	Arc Fault board parameter reading error: Error in the parameter reading by the system.	<ul style="list-style-type: none"> • Error inside the inverter and cannot be checked externally. - If the problem persists (once the inverter has been switched off and back on again), contact customer assistance.
E056 - Over Temp. (from external box) -  Yellow LED	Excessive temperature measured inside the inverter's wiring box: High internal temperature. This error relates to the temperature measured on external boxes (e.g.:TRIO-20.0/27.6kW).	<ul style="list-style-type: none"> • Check that the inverter is not exposed to direct sunlight. Wait for the temperatures to which the inverter is exposed to return to the operating range and for the inverter to cool down. - If the problem persists (once the ambient temperature has returned to within the range), contact customer assistance. Remember to wait the time needed to allow the inverter to cool down
E057 - Vbulk reading error -  Yellow LED	Input voltage (Vin) higher than booster voltage (Vbulk): The error occurs if the input voltage exceeds the Bulk voltage (voltage on the DC-DC circuit inside the inverter)	<ul style="list-style-type: none"> • It is necessary to measure the input voltage inside the inverter with a voltmeter. - If it is higher than the maximum voltage of the operating range, the alarm is genuine and it is necessary to check the configuration of the PV generator. If the voltage has also exceeded the maximum input threshold the inverter could be damaged. - If it is lower than the maximum voltage of the operating range, the alarm is caused by an internal malfunction and it is necessary to contact customer assistance.
E058 - Pin vs Pout check error -  Yellow LED	Error in the check of Pin vs Pout: The error occurs if the difference between the measured value of input power and that of output power is greater than the limit imposed internally to the inverter.	<ul style="list-style-type: none"> • Error inside the inverter and cannot be checked externally. - If the problem persists (once the inverter has been switched off and back on again), contact customer assistance.
E065 - Stop Button -  Yellow LED	Emergency (stop) button activated: This code marks the activation of the emergency button (button pressed). This warning is activated only where there is DC or AC voltage as, if the emergency button is pressed while it is operating only by battery, it causes the whole system to shut down.	<ul style="list-style-type: none"> • Check that the emergency button has been pressed and if necessary deactivate it. - If the warning persists even though the button has been deactivated, contact customer assistance.
E066 - Charger-Bulk -  Yellow LED	Error in the "Charger" circuit: Error internal to inverter relating to the bulk voltage of the circuit linked to battery charger	<ul style="list-style-type: none"> • Error inside the inverter and cannot be checked externally. - If the problem persists (once the inverter has been switched off and back on again), contact customer assistance.
E067 - Charger - OV -  Yellow LED	Overvoltage of "battery charger" ("Charger" circuit): Error inside the inverter. The alarm is raised when the battery charger voltage exceeds the overvoltage threshold (internal unchangeable threshold).	<ul style="list-style-type: none"> • The error might continue when the battery is disconnected (e.g. activation of emergency button). • If the message persists and is not linked to the battery being disconnected, contact customer assistance.
E068 - Charger - OC -  Yellow LED	Overcurrent of "battery charger" ("Charger" circuit): Error inside the inverter.	<ul style="list-style-type: none"> • Error inside the inverter and cannot be checked externally. - If the problem persists (once the inverter has been switched off and back on again), contact customer assistance.
E069 - Charger-SlowRamp -  Yellow LED	Error internal to inverter linked to the battery pack charger circuit ("Charger" circuit):	<ul style="list-style-type: none"> • Error inside the inverter and cannot be checked externally. - If the problem persists (once the inverter has been switched off and back on again), contact customer assistance.
E070 - Charger-preChar. -  Yellow LED	Error inside the inverter.	<ul style="list-style-type: none"> • Error inside the inverter probably linked to the fuse in the damaged battery pack; the error cannot be verified externally. - If the problem persists (once the inverter has been switched off and back on again), contact customer assistance.
E074 - Internal error -  Yellow LED	Communication error inside the inverter: The alarm occurs when there are communication problems between the control devices inside the inverter.	<ul style="list-style-type: none"> • Error inside the inverter and cannot be checked externally. - If the problem persists (once the inverter has been switched off and back on again), contact customer assistance.
E077 - Internal Error -  Yellow LED	Error in the system configuration: Error inside the inverter	<ul style="list-style-type: none"> • Error inside the inverter and cannot be checked externally. - If the problem persists (once the inverter has been switched off and back on again), contact customer assistance.
E078 - Riso Test fail -  Yellow LED	Riso test error: Problem detected during the Riso test phase.	<ul style="list-style-type: none"> • Error inside the inverter and cannot be checked externally. - If the problem persists (once the inverter has been switched off and back on again), contact customer assistance.



- Error code - Error message - Warning	Name of Alarm and Cause	Solution
E079 - Wrong Sequence - Yellow LED	Incorrect Phases connection (Only triphase models) The phases have not been connected correctly to the AC output	<ul style="list-style-type: none"> • Invert two of the phases of the network wiring to the AC terminal block of the inverter.
E081 - Internal Error - Red LED	Inverter fault / Incomplete inverter closing: Fault inside the inverter or incomplete inverter closing (front cover missing or not tightened, cable glands missing or incorrectly tightened, environmental protection IP65 not guaranteed)	<ul style="list-style-type: none"> • If the problem has occurred during the installation phase or during the inverter maintenance phase (therefore the cover has been removed or the cable glands have been acted upon), carry out the following operations: <ul style="list-style-type: none"> - Disconnect the AC grid and DC input from the inverter and check for the front cover and all the cable glands, also checking their correct tightening to ensure environmental protection IP65; reconnect the AC grid and the DC input and attempt to switch the inverter on; if the problem persists, contact customer assistance : - If the front cover and all cable glands are present, disconnect the AC grid and DC input from the inverter and wait 15 minutes at a safe distance, then open the inverter cover and if no smoke/smell of burning is present, check the integrity of the components or the presence of moisture or other abnormal conditions; reconnect the AC grid and DC input and attempt to switch on the inverter; if the problem persists contact customer assistance. • If the problem has occurred after installation or after an inverter maintenance phase (therefore the cover has NOT been removed or the cable glands have NOT been acted upon), disconnect the AC grid and the DC input from the inverter and contact customer assistance.
E084 - BackFeed OC - Yellow LED	Return current to photovoltaic field: The error occurs if the input voltage is particularly low (typically in the evening in conditions of low irradiation) and indicates a return current from the inverter to the photovoltaic panels).	If the error occurs in the evening or in conditions of low irradiation, it must not be considered a problem but a protection intervention for the photovoltaic field. <ul style="list-style-type: none"> - If the error occurs with good irradiation conditions, switch the inverter off and back on again; if the error persists, contact customer assistance.
E086 - Batt. 1 - F2 - No LED	Error battery pack 1 unusable: Indicates that the battery pack is unusable and must be replaced.	<ul style="list-style-type: none"> • Error inside battery pack 1 and cannot be checked externally. - If the problem (once the system has been switched off and back on) persists, contact customer assistance.
E087 - Batt. 2 - F2 - No LED	Error battery pack 2 unusable: Indicates that the battery pack is unusable and must be replaced.	<ul style="list-style-type: none"> • Error inside battery pack 2 and cannot be checked externally. - If the problem (once the system has been switched off and back on) persists, contact customer assistance.
E088 - Batt. 3 - F2 - No LED	Error battery pack 3 unusable: Indicates that the battery pack is unusable and must be replaced.	<ul style="list-style-type: none"> • Error inside battery pack 3 and cannot be checked externally. - If the problem (once the system has been switched off and back on) persists, contact customer assistance.
E089 - Wrong Wiring - Yellow LED	Incorrect grid wiring connection on Stand Alone: The error occurs if the grid cables have been incorrectly connected to the Stand Alone output.	<ul style="list-style-type: none"> • Check that the cables on the Stand Alone output have been installed correctly.



Power limitation messages

The equipment can signal possible output power limitations which may occur on the basis of:

- settings made by the user
- settings required by the grid standard of the country of installation
- protective devices inside the inverter

The signals and the messages can only be verified using the internal Webserver.

The following table gives the complete list of power limitation messages relating to string inverters.

Some messages may not be used depending on the inverter model installed.

- Message on display - Signal	Name of Derating and Cause	Solution
- LIMxxx% CODE:00	<p>Power limitation: The message indicates that the user has set an output power limitation for the inverter. LIM xxx% = Power reduction percentage Examples: LIM 100% = no power limitation LIM 50% = limitation to 50% of the output nominal power</p>	<ul style="list-style-type: none"> • Check the limitation value in "Settings > Power Reduction".
- LIMxxx% CODE:01	<p>Power limitation for over-frequency: The message indicates that the user has set a power limitation due to over frequency in order to reduce the maximum output power of the inverter when the grid frequency exceeds certain limits. LIM xxx% = Power reduction percentage Examples: LIM 100% = no power limitation LIM 50% = limitation to 50% of the output nominal power</p>	<ul style="list-style-type: none"> • Check the limitation value set in "Settings > Service Power > OF Derating"
- LIMxxx% CODE:02	<p>Power limitation for over-voltage: The message indicates that the user has set a power limitation due to overvoltage (parameter U >(10 min)) in order to reduce the maximum output power of the inverter when the reading of the average grid voltage exceeds certain limits. The sampling of readings is done every 10 minutes (U>(10min)). LIM xxx% = Power reduction percentage Examples: LIM 100% = no power limitation LIM 50% = limitation to 50% of the output nominal power</p>	<ul style="list-style-type: none"> • Check the limitation value in "Settings > Service Power > U>(10min) Der."
- LIMxxx% CODE:03	<p>Anti-islanding power limitation: The message indicates that a power limitation is active since an "islanding" condition has been recorded. LIM xxx% = Power reduction percentage Examples: LIM 100% = no power limitation LIM 50% = limitation to 50% of the output nominal power</p>	<ul style="list-style-type: none"> • If the inverter remains connected to the grid and the limitation is active, contact customer assistance
- LIMxxx% CODE:04	<p>Power limitation due to low grid voltage: The message indicates that an output power limitation may occur since a low grid voltage (AC) condition has been recorded. LIM xxx% = Power reduction percentage Examples: LIM 100% = no power limitation LIM 50% = limitation to 50% of the output nominal power</p>	<ul style="list-style-type: none"> • Check that the grid voltage is lower than the minimal voltage. Should this condition persist, contact the grid operator to resolve the problem.



- Message on display - Signal	Name of Derating and Cause	Solution
- LIMxxx% CODE:05	<p>Power limitation due to excess temperature: The message indicates that a power limitation is active since an excess temperature condition has been recorded inside the inverter (This parameter depends also on the power which the inverter must provide since the measurement of temperatures is taken internally and is influenced by the heat dissipated by the components of the inverter itself). LIM xxx% = Power reduction percentage Examples: LIM 100% = no power limitation LIM 50% = limitation to 50% of the output nominal power</p>	<ul style="list-style-type: none"> • Check that the inverter is not exposed to direct sunlight. Wait for the temperatures to which the inverter is exposed to return to the operating range and for the inverter to cool down. - If the problem (once the ambient temperature has returned within the range) persists, contact customer assistance.
- LIMxxx% CODE:06	<p>Power limitation for input over-voltage: The message indicates that a power limitation is active since an input overvoltage (AC) has been recorded. LIM xxx% = Power reduction percentage Examples: LIM 100% = no power limitation LIM 50% = limitation to 50% of the output nominal power</p>	<ul style="list-style-type: none"> • It is necessary to measure the input voltage inside the inverter with a voltmeter. - If it is higher than the maximum voltage of the operating range, the alarm is genuine and it is necessary to check the configuration of the PV generator. If the voltage has also exceeded the maximum input threshold the inverter could be damaged. - If it is lower than the maximum voltage of the operating range, the alarm is caused by an internal malfunction and it is necessary to contact customer assistance.



Procedure for dismantling the Inverter

To dismantling and disassemble the appliance, refer to the chapters:
Mounting on a vertical or horizontal support

Follow the indications for the mounting procedure but in the reverse order



Perform the steps for “Inverter switch-off” based on the model, before removing one of the two wiring boxes or the inverter itself.

*Never open the wiring boxes in the case of rain, snow or a level of humidity >95%.
Always carefully seal all unused openings.*

Even though the device is equipped with an anti-condensation valve, air with extremely high levels of humidity can lead to the creation of condensation inside the inverter.

As the inverter is almost completely insulated from the outside, condensation can also form after maintenance interventions in certain weather conditions.

IP65

During dismantling must be installed caps on interface quick connectors on the inverter parts that are installed and exposed to the elements.



Registration on “Registration” website and calculation of security token (Admin Plus)

In order to obtain the security token needed to obtain the “Admin Plus” privileges in the web user interface, it is necessary to go through the following stages:

Stage 1 - Collection of information relating to the inverter.

Collect the following information relating to each inverter for which you wish to have the security token:

- **S/N** - Serial number of the inverter. This information can be found on the product label giving the identity details of the inverter.

The serial number consists of 6 digits (the last 6 in models with a label giving a 10-digit S/N).

- **WK** - Production week. This information can be found on the product label giving the identity details of the inverter.

The production week consists of 4 figures, indicating the week (first 2 digits) and the year of production (last 2 digits).

Stage 2 - Registration on <https://registration.abbsolarinverters.com>

- Go online and access <https://registration.abbsolarinverters.com>
- Set the desired language and click on the specific icon to start registration

- Insert the personal data requested and end the registration stage
- An email will be sent to the email address used with a link to complete the registration process.
- Once the registration process is over, a further email will be sent with the password to access the website.



The security token obtained enables access also to the advanced “Installer” mode present on the configuration software for inverters. The configuration software can be downloaded in a specific section of the website <https://registration.abbsolarinverters.com>

Stage 3 - Request for the security token

- Go online and access <https://registration.abbsolarinverters.com>
- Insert the Username (corresponding to the email used during registration) and the Password obtained at the end of Stage 2

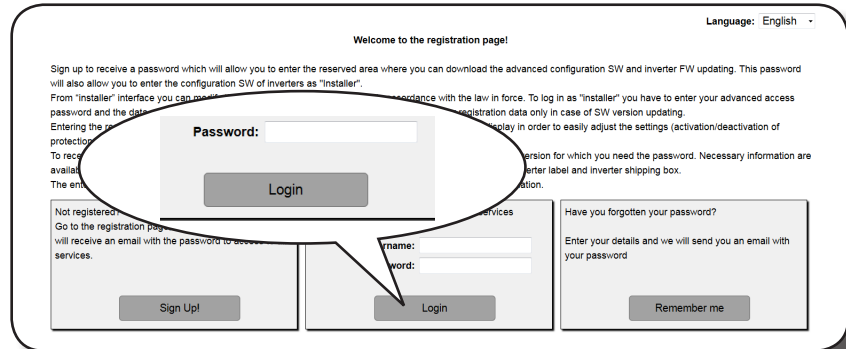

- Access the section dedicated to requesting the security token

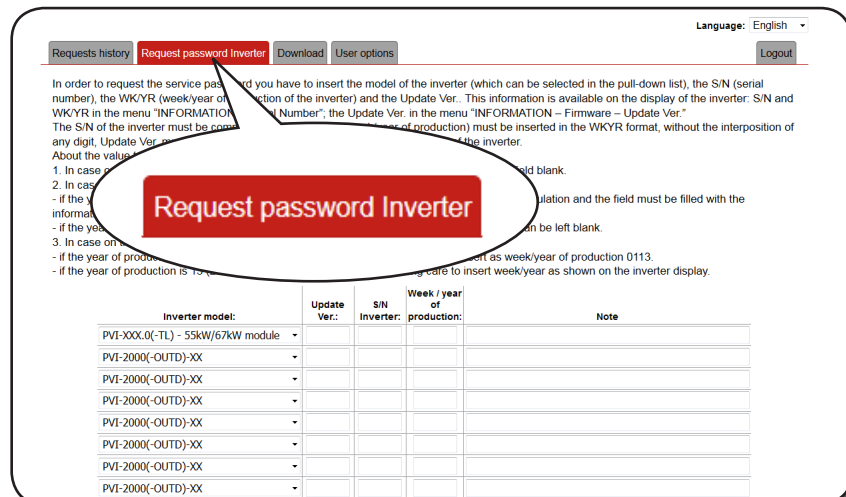

- Choose the inverter model from the drop-down list and insert Serial Number and Week of Production of the inverter which were obtained previously (Stage 1)

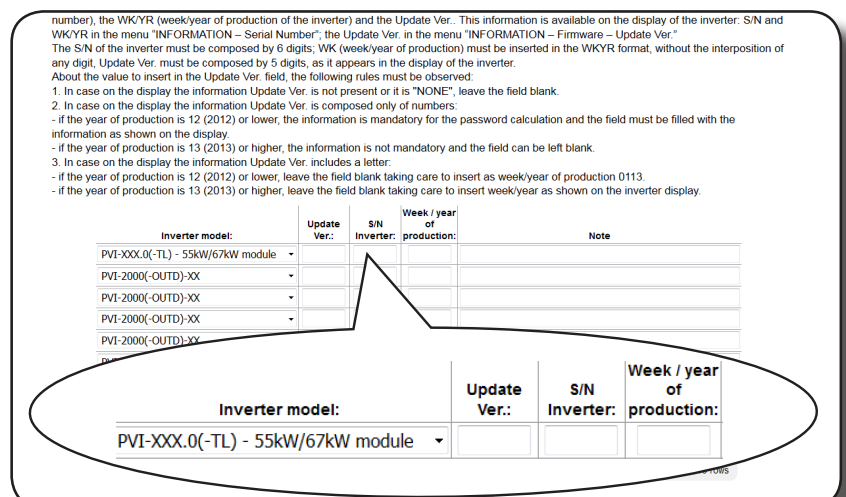

- Click on icon to request the security token.

Language: English

Requests history **Request password inverter** Download User options Logout

In order to request the service password you have to insert the model of the inverter (which can be selected in the pull-down list), the S/N (serial number), the WK/YR (week/year of production of the inverter) and the Update Ver.. This information is available on the display of the inverter: S/N and WK/YR in the menu "INFORMATION – Serial Number"; the Update Ver. in the menu "INFORMATION – Firmware – Update Ver."
 The S/N of the inverter must be composed by 6 digits, WK (week/year of production) must be inserted in the WK/YR format, without the interposition of any digit, Update Ver. must be composed by 5 digits, as it appears in the display of the inverter.
 About the value to insert in the Update Ver. field, the following rules must be observed:

- In case on the display the information Update Ver. is not present or it is "NONE", leave the field blank.
- In case on the display the information Update Ver. is composed only of numbers:
 - if the year of production is 12 (2012) or lower, the information is mandatory for the password calculation and the field must be filled with the information as shown on the display.
 - if the year of production is 13 (2013) or higher, the information is not mandatory and the field can be left blank.
- In case on the display the information Update Ver. includes a letter:
 - if the year of production is 12 (2012) or lower, leave the field blank taking care to insert as week/year of production 0113.
 - if the year of production is 13 (2013) or higher, leave the field blank taking care to insert week/year as shown on the inverter display.

Inverter model:	Update Ver.:	S/N Inverter:	Week / year of production:	Note
PVI-XXX.0(-TL) - 55KW/67KW module		123456	1117	
PVI-2000(-OUTD)-XX				
PVI-2000(-OUTD)-XX				
PVI-2000(-OUTD)-XX				
PVI-2000(-OUTD)-XX				
PVI-2000(-OUTD)-XX				
PVI-2000(-OUTD)-XX				
PVI-2000(-OUTD)-XX				
PVI-2000(-OUTD)-XX				
PVI-2000(-OUTD)-XX				
PVI-2000(-OUTD)-XX				

Add other 10 rows

Do request

Should there be an error in inputting data, the fields containing the error will be highlighted in red. If, on the other hand, the data are correct, the passwords will be shown in a new window and at the same time sent to the email address used for registration.



The security token enables the "Admin Plus" privileges which allows the inverter's sensitive parameters to be changed. Proceed to changing the aforementioned parameters only when requested by the grid operator or by customer assistance.



Replacing DC string fuses



Some inverter parts may be subject to voltages that could be hazardous for the operator. Before performing any work on the inverter, refer to “Inverter switch-off” chapter on this manual to know all the necessary step to safely operate on the inverter.

The string protection fuses (where present) in the inverter may need to be replaced in the following circumstances:

1. Adjustment of the fuse value on the basis of the type of PV panels used
2. Damaged fuse

Procedure for replacing string fuses from positive ⁽³⁵⁾ or negative ⁽³⁴⁾ (only on -SX, -SX2 model) string fuses board:

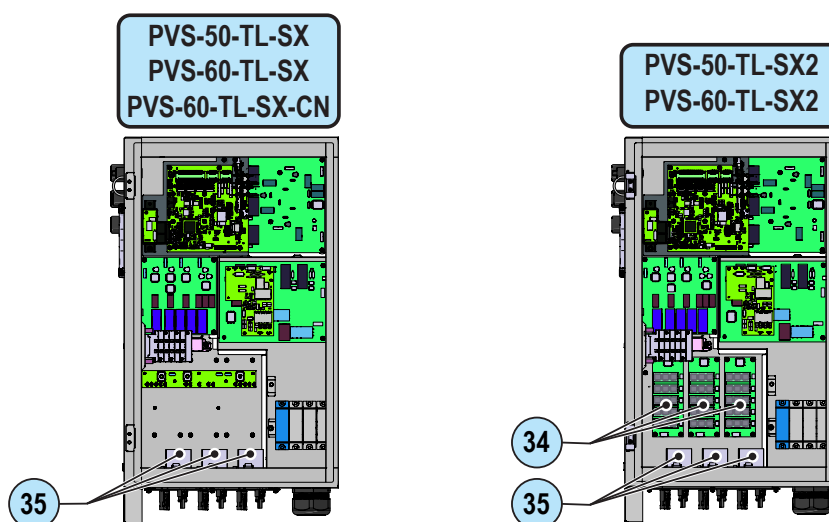

1. Open any AC disconnect switch downstream of the inverter.
2. Open the DC disconnect switches ⁽¹⁵⁾



By only disconnecting the AC disconnect switch and the DC disconnect switch, the DC input voltage is still present on the fuse board. Use adequate PPE (personal protective equipment).

3. Disconnect the strings by disconnecting the quick fit input connectors ⁽¹⁹⁾ ⁽²⁰⁾ ⁽²¹⁾.
4. Wait enough time for the stored energy to be discharged (min time 30 minutes).
5. Open the wiring box front cover ⁽⁰⁴⁾
6. Remove the fuse to be replaced
7. Introduce the new fuse into the fuse holder on the string fuse boards

Replacing cooling section



Some inverter parts may be subject to voltages that could be hazardous for the operator. Before performing any work on the inverter, refer to "Inverter switch-off" chapter on this manual to know all the necessary step to safely operate on the inverter.

Procedure for replacing cooling section:

1. Perform the "inverter switch-off" procedure before operate on the inverter
2. Remove the 6 screws of the cooling section.

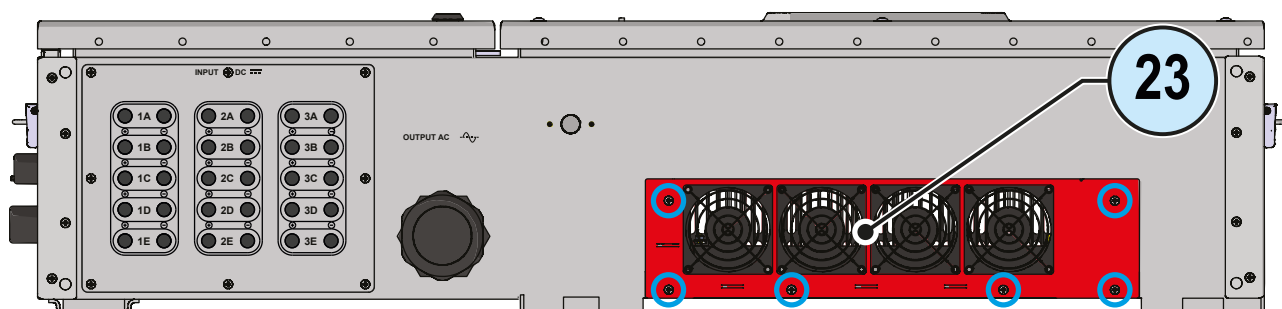

3. Pull out the cooling section

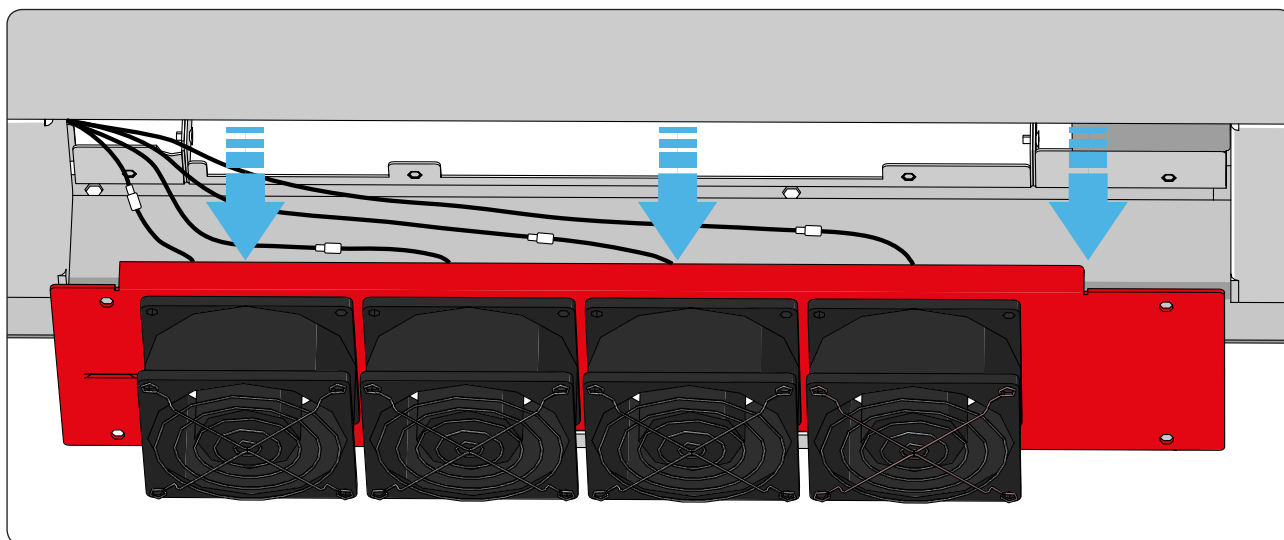

4. Disconnect the fan connectors
5. Take the new cooling section and connect the 4 fan connectors. During this phase pay attention to connect the fan to the correspondent cable (the cables have different length based on the fan position).
6. Place the new cooling section on the lower side of the inverter
7. Screw the 6 fastening screws

Replacement of the buffer battery



Some inverter parts may be subject to voltages that could be hazardous for the operator. Before performing any work on the inverter, refer to “Inverter switch-off” chapter on this manual to know all the necessary step to safely operate on the inverter.

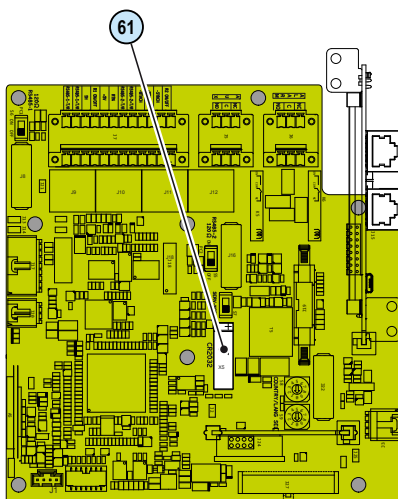

Replacing the buffer battery (61) is carried out on the wiring box and may be necessary in the following circumstances:

1. LED error signal
2. Reset of the date and time settings

The battery is of the **CR2032** type and is installed on the communication and control board (30).

Procedure to replace the buffer battery (61):

1. Open any AC disconnect switch of the inverter.
2. Open any DC disconnect switch:
 - Upstream of the inverter on -Standard model.
 - Open the DC disconnect switch (15) on -S, -SX and -SX2 model.
3. Disconnect the quick fit input connectors on -SX and -SX2 model.
4. Wait 30 minutes before open the wiring box front cover (04).
5. Remove the buffer battery (61) to be replaced
6. Install the new battery, taking care to handle it with insulating gloves in order not to compromise the charge and respecting the polarity shown on the diagram on the communication and control board (30)

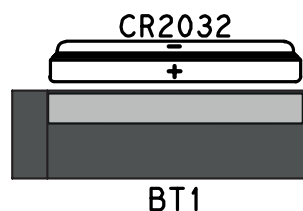
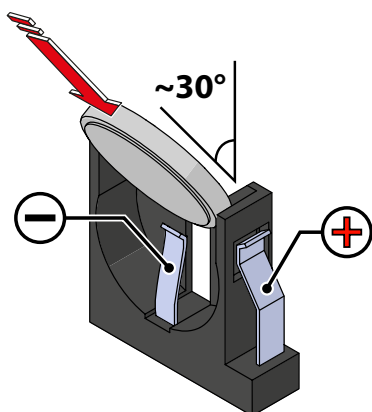

7. Reconnect all the input strings and start the inverter.

Verification of ground leakage

In the presence of anomalies or report of ground fault (where provided), there may be a ground leakage from the PV generator (DC side).

To check this, measure the voltage between the positive pole and ground and between the negative pole (of the PV generator) and ground using a voltmeter whose input accepts a voltage sufficient for the dimensions of the photovoltaic generator.

Behaviour of a system without leakage

Due to the capacitive effect of the PV generator, during the first moments that the voltmeter is connected between one of the two poles and ground, it will measure a voltage of about $V_{oc}/2$, which will tend to stabilize to around 0V if there is no ground leakage, as shown in the graph below:

The internal resistance of the voltmeter tends to zero the voltage present on the PV generator due to the capacitive effect.

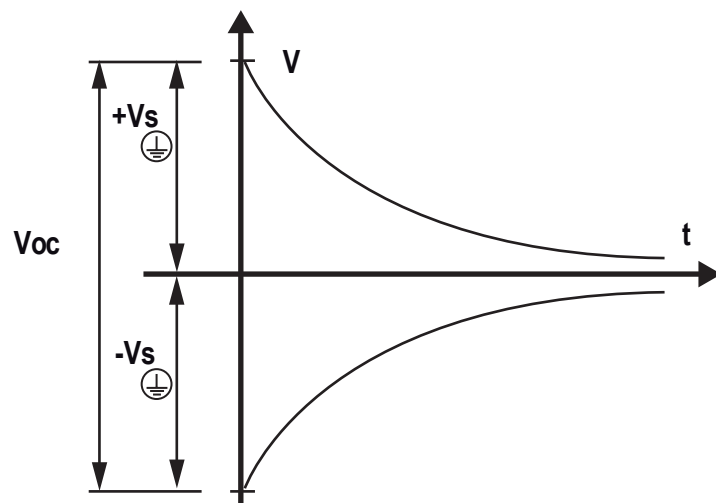

How to make the measurement:

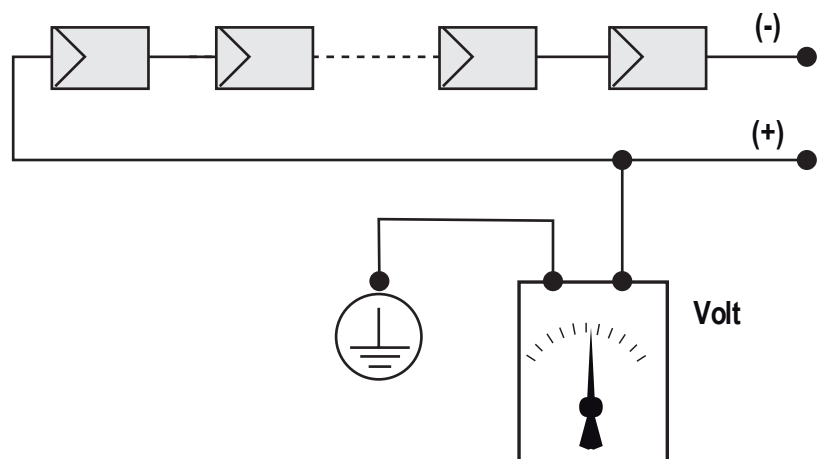

Behaviour of a system with leakage

If the voltage measured between one of the two poles and ground does not tend to 0V and stabilizes on a value, there is a ground leakage from the PV generator.

Example: When the measurement is made between positive pole and ground, a voltage of 200V is measured.

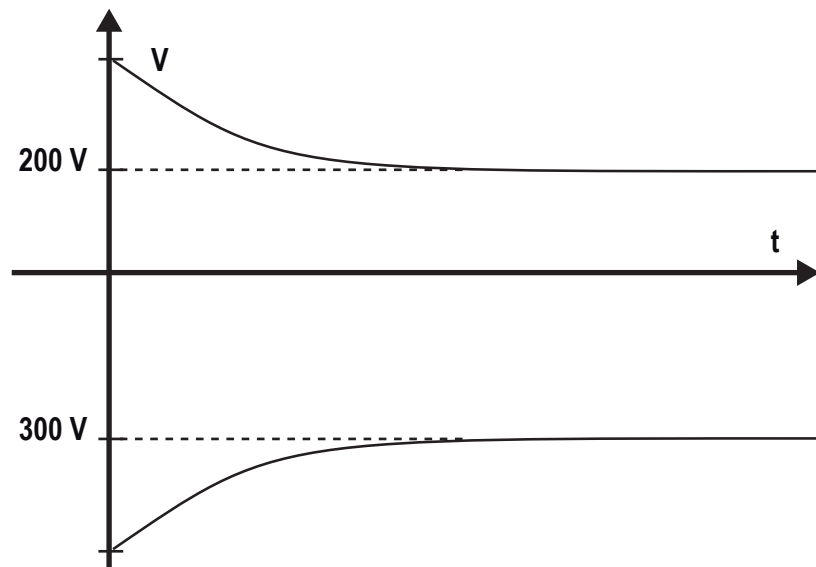

This means that if the system is made up of 10 modules in series and each one supplies 50V, the leakage can be located between the 4th and 5th PV module.

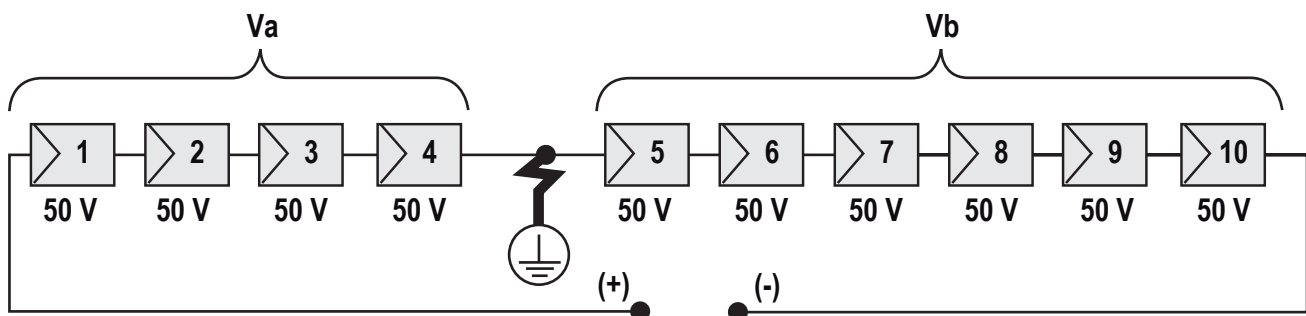

V_a = voltage measured between + pole and \oplus = 200V

V_b = voltage measured between - pole and \oplus = 300V

In all measurements with \oplus , the ground of the inverter is indicated.

Measuring the isolation resistance of the PV generator.



Staff authorised to carry out the installation must be specialised and experienced in this job. They must also have received suitable training on equipment of this type.



Always use personal protective equipment (PPE) provided by the employer and comply with local safety regulations.

To measure the isolation resistance of the PV generator compared to ground (⊕), the two poles of the PV generator must be short-circuited (using a suitably sized selector).

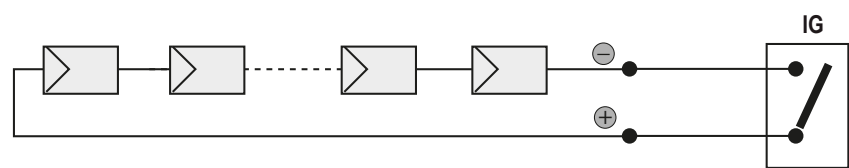

Once the short-circuit has been made, measure the isolation resistance (Riso) using a megohmmeter positioned between the two shorted poles and ground (of the inverter).

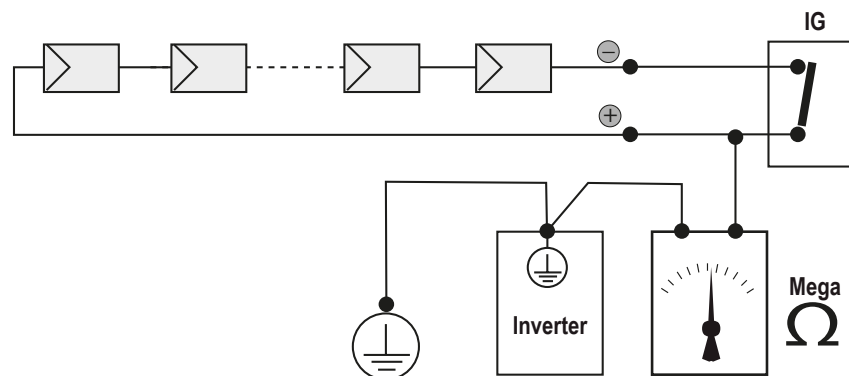

MODELS - TL (without isolation transformer). If the measured isolation resistance (Riso) is less than 500 MOhm, the inverter may not connect to the grid because of low isolation of the PV generator to ground.

MODELS - I (with isolation transformer). If the measured isolation resistance (Riso with floating input poles compared to ground or QF=1 with grounding of one of the two inlet poles) is lower than 0.2 MOhm, the inverter will not connect to the grid due to low isolation of the PV generator to ground.

The isolation resistance can be affected by the environmental conditions the PV generator is in (E.g.: PV modules wet from damp or rain), and therefore the measurement must be made immediately after the anomaly is detected

Storage and dismantling

Storage of the equipment or prolonged stop

If the equipment is not used immediately or is stored for long periods, check that it is correctly packed and contact **ABB** for storage instructions. The equipment must be stored in well-ventilated indoor areas having no characteristics that could damage the components of the equipment.

Restarting after a long or prolonged stop requires a check and, in some cases, the removal of oxidation and dust that will also have settled inside the equipment if not suitably protected.

Dismantling, decommissioning and disposal

ABB is not responsible for any loss of the equipment, or part of it, which does not take place on the basis of the regulations and laws in force in the country of installation.



The symbol of the cancelled bin (where present) indicates that the product must not be disposed of with domestic waste at the end of its useful life.

This product must be delivered to the waste collection point of the local community for recycling.

For further information, refer to the public body responsible for waste disposal in the country.

Inappropriate disposal of waste can have a negative impact on the environment and human health owing to potentially dangerous substances.

By cooperating in the correct disposal of this product, you contribute to the reuse, recycling and recovery of the product, and the protection of our environment.

Dispose of the various types of materials that the parts of the equipment consist of in dumps that are suitable for the purpose.

COMPONENT	MATERIAL OF CONSTRUCTION
Frame, brackets, supports	Arc-welded steel FE37, aluminium
Casing or covers	ABS, plastic
Paint	RAL
Gaskets and seals	Rubber / Teflon / Viton
Electrical cables	Copper / Rubber
Cable trays	Polyethylene / Nylon
Batteries	Nickel / Lead/ Lithium

Attachments

9

Port and network services used by the inverter

IP Network Services

Any network connected to the inverter must allow traffic to pass on the following ports. Network firewall rules (if present) must allow responses to the inverter over existing TCP connections.

Direction	Service/Port	Protocol	Description
Out	ssh/22	Tcp	For remote debugging by ABB service personnel, the inverter utilizes encrypted SSH Remote Login Protocol. To allow service personnel remote access to the inverter, this port has to be opened in any firewall and forwarded to the inverter. (preferred)
Out	domain/53	Tcp/udp	The inverter must be able to resolve domain names, to ensure scalability and dynamic changes on the Internet (DNS). (required)
Out	https/443	Tcp	As an HTTP client, the inverter uses SSL/TLS protocol connections to Aurora Vision® servers for secure communication. The inverter uses this port for all services, including data transmission, firmware upgrade, configuration management, and remote command transmission. (required)
Out	dhcp/67, dhcp/68	Udp	If DHCP service is not available, static network information must be assigned to the inverter (preferred)
Out	ntp/123	Udp	The inverter uses this port for network time services (NTP). (preferred)



Network Hosts

The inverter will connect to the following hosts. Some servers owned by ABB, and others are customer or ISP servers. Servers listed as owned by "Customer IT/ISP" must be configured in the inverter using either DHCP or as static network information.

Host	Purpose	Port	Owner/Manager
platform.auroravision.net	Data, configuration	TCP:443	ABB
gw1.auroravision.net and/or apt.fatspaniel.net	Inverter firmware upgrade	TCP:443	ABB
Site dependent	DHCP (optional)	UDP:67, UDP:68	Customer IT/ISP
Site dependent	DNS	UDP:53, TCP:53	Customer IT/ISP

Inverter network configuration

The inverter requires a valid network configuration in order to operate. This information can either be provided by a DHCP server provided by the customers network (the default), or the inverter can be configured with static network information. Regardless of how the inverter is configured, the following information is required.

Configuration	Purpose
IP Address	Allows the inverter to take part in the local network. This does not need to be a public IP address. In most cases this is a private IP address.
Subnet mask	Used to determine if two computers are on the same network.
Gateway	The IP address of the computer which will forward network traffic from the local network to an external network
DNS Server	The IP address(es) of the computer(s) which resolve domain names.



Further information

For more information on ABB solar products and services,
visit www.abb.com/solarinverters

Contact us

www.abb.com/solarinverters

