

## User manual

# Solar Grid-tied Inverter

Product Model: SOFAR 60K~80KTLX-G3



---

Preface .....	III
1. Basic Safety Information .....	1
1.1. Requirement for Installation and Maintenance .....	1
1.2. Symbols and signs .....	5
2. Product Characteristics .....	7
2.1. Intended Use .....	7
2.2. Function Description .....	10
2.3. Electrical block diagram .....	11
2.4. Efficiency and derating curve .....	12
3. Inverter Storage .....	13
4. Installation .....	14
4.1. Installation Process .....	14
4.2. Checking Before Installation .....	14
4.3. Tools .....	16
4.4. Determining the Installation Position .....	19
4.5. Moving of inverter .....	21
4.6. Installation .....	22
5. Electrical Connection .....	24
5.1. Electrical Connection .....	25
5.2. Grounding Connection (PE) .....	25
5.3. Connect grid side of inverter(AC-Output) .....	27
5.4. Connect PV side of inverter (DC-Input) .....	31
5.5. Communication Connection .....	34
6. Commissioning of inverter .....	38

6.1. Cable Connection Inspection .....	38
6.2. Start Inverter .....	38
7. Operation interface .....	40
7.1. Operation and Display Panel .....	40
7.2. Standard Interface .....	41
7.3. Main Interface .....	45
7.4. Updating Inverter Software .....	48
8. Trouble shooting and maintenance .....	54
8.1. Troubleshooting .....	51
8.2. Daily Maintenance .....	61
8.3. Fan Maintenance .....	61
9. Technical Data .....	63
9.1. Technical Data List .....	63
10. Quality Assurance .....	66

# Preface

## Notice

The products, services or features you purchased shall be subject to the company's commercial contracts and terms. All or part of the products and services described in this document may not within the scope of your purchase. Unless additional terms and conditions in your contract, the company does not make any statement or guarantee on the contents of this document.

## Save this Instruction

This manual must be considered as an integral part of the equipment. Customer can print the electronic version to hard copy and keeping properly for future reference. Anyone who operates the device at any time must operate in accordance with the requirements of this manual.

## Copyright Declaration

The copyright of this manual belongs to Shenzhen SOFARSOLAR Co., Ltd. Any corporation or individual should not plagiarize, partially cope or fully copy (including software, etc.), not allow to duplication and publishment in any form and any way. All rights reserved, SOFARSOLAR reserves the right of final interpretation. This manual subject to modify according to user's or customer's feedback. Please check our website at <http://www.sofarsolar.com> for lasted version.

## Document Updates

V1.0 2022-6-15

- Initial version

## Shenzhen SOFARSOLAR Co., Ltd.

Location: 11/F., Gaoxinqi Technology Building, No.67 Area, Xingdong Community, Xin'an Sub-district, Bao'an District, Shenzhen City, China

Postcode: 518000

Company Website: [www.sofarsolar.com](http://www.sofarsolar.com)

Email: [service@sofarsolar.com](mailto:service@sofarsolar.com)



● **Outline**

This manual is an integral part of SOFAR 60KTLX to 80KTLX-G3. It describes the assembly, installation, commissioning ,maintenance and failure of the product. Please read it carefully before operating.

● **Scope of Validity**

This manual contains important instructions for:

**SOFAR 60KTLX-G3 SOFAR 80KTLX-G3**

**SOFAR 70KTLX-G3 \***





\*Only some certifications include SOFAR 70KTLX-G3.

● **Target Group**

This manual is for qualified electricians. The tasks described in this manual only can be performed by qualified electricians.

● **Symbols Used**

The following types of safety instruction and general information appear in this document as described below:

 <b>Danger</b>	<p>“Danger”indicates a hazardous situation which, if not avoided, will result in death or serious injury.</p>
 <b>Warning</b>	<p>“Warning”indicates a hazardous situation which, if not avoided, could result in death or serious injury</p>
 <b>Caution</b>	<p>“Caution”indicates a hazardous situation which, if not avoided, could result in minor or moderate injury</p>
 <b>Attention</b>	<p>“Attention”indicates there are potential risks, if fail to prevent, may lead to equipment cannot normally or property damage.</p>

**Note**

“Note” provides additional information and tips that are valuable for the optimal operation of the product, will help you to solve a problem or save your time.

# 1. Basic Safety Information

## Outlines of this Chapter

Please read the instruction carefully. Faulty operation may cause serious injury or death .

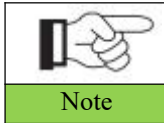

If you have any question or problem when you read the following information, please contact Shenzhen SOFARSOLAR CO., Ltd.

### Safety Instruction

Introduce the safety instruction during installation and operation of SOFAR 60~80KTLX-G3.

### Symbols Instruction

This section gives an explanation of all the symbols shown on the SOFAR 60~80KTLX-G3 on-grid inverter and on the type label.

## 1.1. Requirement for Installation and Maintenance

Installation of SOFAR 60~80KTLX-G3 on-grid inverter must conform with laws, regulations, codes and standards applicable in the jurisdiction.

Before installing and adjusting the produce, please read all of instructions, cautions and warnings in this manual

Before connecting the product to the electrical utility grid, contact the local utility company for allowance. Also, this connection must be made only by qualified electrician.

If the failure persists, please contact the nearest authorized maintenance center. If you don't know which service center is closest to you, please contact your local distributor. Don't repair the product by yourself, which may lead serious injury or damage.

## **Qualified Person**

When inverter is working, it contains lethal voltages and went hot in some area. Improper installation or misoperation could cause serial damage and injury. To reduce the risk of personal injury and to ensure the safe installation and operation of the product, only a qualified electrician is allowed to execute transportation, installation, commissioning and maintenance. Shenzhen SOFARSOLAR Co, Ltd. does not take any responsibility for the property destruction and personal injury because of any incorrect use.

## **Label and Symbols**

SOFAR 60~80KTLX-G3 has type label attach the side of product which contact important information and technical data, the type label must permanent attached to the product.

SOFAR 60~80KTLX-G3 has warning symbol attache the product which contact information of safety operation. The warning symbol must permanent attached to the product.

## **Installation location requirement**

Please install the SOFAR 60~80KTLX-G3 on-grid inverter according to the following section. Place inverter in an appropriate bearing capacity objects (such as solid brick wall, or strength equivalent mounting surface, etc.) and make sure inverter vertical placed. A proper installation location must have enough space for fire engine access in order for maintenance if faulty occur. Ensure the inverter is installed in a wall ventilated environment and have enough air cooling cycle. Air humidity should less than 90%.

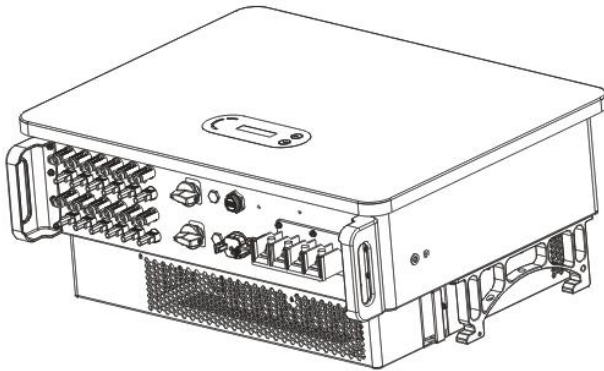



### Transportation Requirement

Inverter is in the good electrical and physical condition when it ship out from factory. During transport, inverter must be placed in its original package or other proper package. Transportation company should responsible for any damage during transport period.



If you find any packing problems that may cause the damage of inverter or any visible damage, please notice the responsible transportation company immediately. You can ask your installer or SOFARSOLAR for help is necessary.

### Electrical Connection



Please comply with all the current electrical regulations about accident prevention in dealing with the current inverter.

	<p>Before the electrical connection, use opaque material to cover the PV modules or disconnect PV string DC switch. PV arrays will produce dangerous voltage if it is exposure under sun.</p>
<p style="background-color: red; color: white; padding: 2px;">Danger</p>	<p>All operation must accomplish by certified electrical engineer</p> <ul style="list-style-type: none"> <li>● Must be trained;</li> <li>● Completely read the manual operation and understand all information.</li> </ul>
	<p>Must get permission by local utility company before connecting to grid and the connection must be done by certified electrical engineers.</p>
<p style="background-color: orange; color: white; padding: 2px;">Warning</p>	
	
<p style="background-color: blue; color: white; padding: 2px;">Attention</p>	

### Operation

	<p>Touching the utility grid or the terminal conductors can lead to lethal electric shock or fire! Do not touch non-insulated cable ends, DC conductors and any live components of the inverter.</p>
<p style="background-color: red; color: white; text-align: center;">Danger</p>	<p>Attention to any electrical relevant instruction and document.</p>
	<p>Enclosure or internal components may get hot during operation. Do not touch hot surface or wear insulated gloves. Keep it away from kids!</p>
<p style="background-color: #0070C0; color: white; text-align: center;">Attention</p>	

### Maintenance and repair

	<p>Before any repair work, turn OFF the AC circuit breaker between the inverter and electrical grid first, then turn OFF the DC switch. After turning OFF the AC circuit breaker and DC switch wait for at least 5 minutes before carry any maintenance or repair work.</p>
<p style="background-color: red; color: white; text-align: center;">Danger</p>	
	<p>Inverter should not work again until removing all faults. If any repair work is required, please contact local authorized service centre. Should not open the inverter cover without authorized permit, SOFARSOALR does not take any responsibility for that.</p>
<p style="background-color: #0070C0; color: white; text-align: center;">Attention</p>	





### EMC/Noise Level

Electromagnetic compatibility (EMC) refers to that on electrical equipment functions in a given electromagnetic environment without any trouble or error, and impose no unacceptable effect upon the environment. Therefore, EMC represents the quality characters of an electrical equipment.

- The inherent noise-immune character: immunity to internal electrical noise
- External noise immunity: immunity to electromagnetic noise of external system
- Noise emission level: influence of electromagnetic emission upon environment



	<p>Electromagnetic radiation from inverter may be harmful to health! Please do not continue to stay away from the inverter in less than 20cm when inverter is working</p>
<p style="background-color: red; color: white; text-align: center;">Danger</p>	





## 1.2. Symbols and signs

	High voltage of inverter may be harmful to health! Only certified engineer can operate the product; Juveniles, Disable, should not use this product;
<b>Danger</b>	Keep this product out of the reach of children;
	Caution of burn injuries due to hot enclosure! Only touch the screen and pressing key of the inverter while it is working
<b>Caution</b>	
	PV array should be grounded in accordance to the requirements of the local electrical grid company
<b>Attention</b>	
	Ensure the maximum DC voltage input is less than the maximum inverter DC voltage (including in low temperature condition). Any damage cause by over-voltage, SOFARSOLAR will not take the responsibility including warranty
<b>Warning</b>	

### Signs on the Product and on the Type Label

SOFAR 60~80KTLX-G3 has some safety symbols on the inverter. Please read and fully understand the content of the symbols before installation.

Symbols	Name	Explanation
	This is a residual voltage in the inverter!	After disconnect with the DC side, there is a residual voltage in the inverter, operator should wait for 5 minutes to ensure the capacitor is completely discharged.
	Caution of high voltage and electric shock	The products operates at high voltages. Prior to performing any work on the product, disconnect the product from voltage sources. All work on the product must be carried out by qualified persons only.
	Caution of hot surface	The product can get hot during operation. Avoid contact during operation. Prior to performing any work on the product, allow the product

		to cool down sufficiently
	Comply with the Conformance Euroeenne (CE) Certification	The product comply with the CE Certification
	Grounding Terminal	This symbol indicates the position for the connections of an additional equipment grounding conductor
	Observe the documentation	Read all documentation supplied with the product before install
	Positive pole and negative pole	Positive pole and negative pole of the input voltage (DC)
	Temperature	Indicated the temperature allowance range



# 2. Product Characteristics

## Outlines of this Chapter

### Product Dimensions

Introduce the field of use and the dimensions of the SOFAR 60~80KTLX-G3 on-grid inverter.

### Function Description

Introduce working principle and internal components of the SOFAR 60~80KTLX-G3 on-grid inverter.

### Efficiency Curves

Introduce the efficiency curves of the Inverter.

## 2.1. Intended Use

The SOFAR 60~80KTLX-G3 on-grid inverter can transform a direct electric current (DC) coming from a photovoltaic generator (PV) into an alternating electric current (AC) Suitable for being fed into the utility grid.

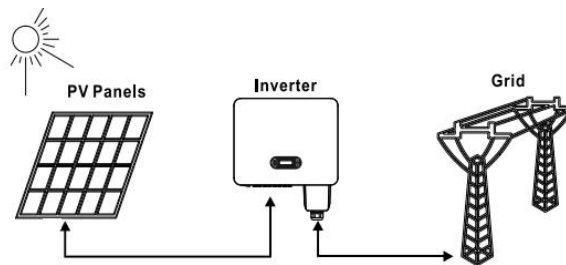

Figures 2-1PV Grid-Tied System

The SOFAR 60~80KTLX-G3 on-grid inverter may only be operated with PV arrays (photovoltaic module and cabling) for on grid condition. Do not use this product for any other or additional purposes. Any damage or property loss due to any use of the product other than described in this section, SOFARSOLAR will not take the

responsibility. DC input of the product must be PV module, other source such like DC sources, batteries will against the warranty condition and SOFARSOLAR will not take the responsibility.

## Supported grid types

According to the SOFAR 60~80KTLX-G3 configurations, for the TT type of electricity grid, the voltage between neutral and earth should be less than 30V. Inverters are compatible with TN-S, TN-C, TN-C-S, TT, IT grid.

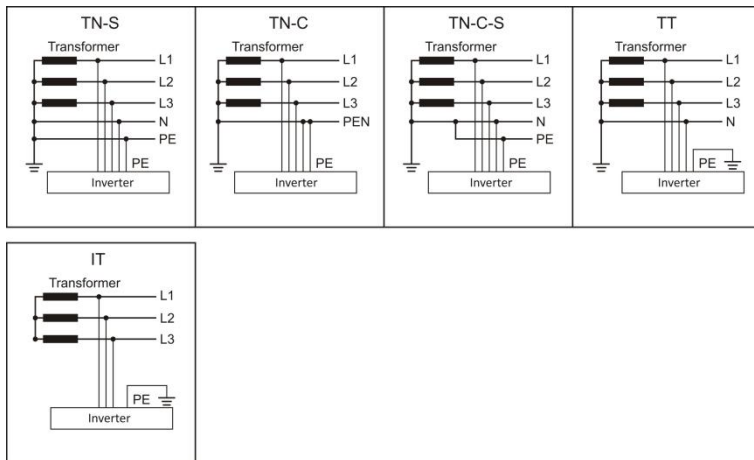

Figure2-2 Overview of the grid types

## Product Dimensions

The choice of optional parts of inverter should be made by a qualified technician who knows the installation conditions clearly.

### Dimensions Description

- SOFAR 60~80KTLX-G3  
L×W×H=687\*561\*275mm

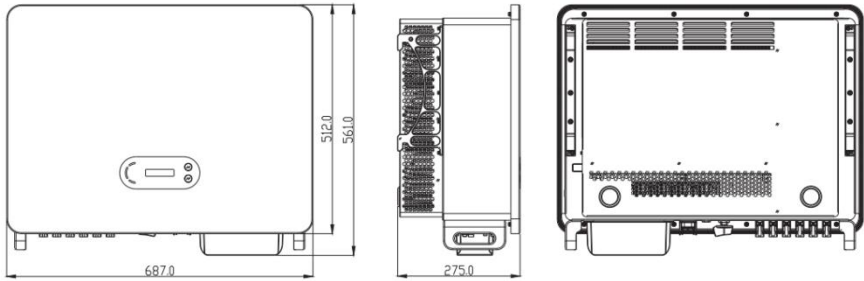

Figure 2-3 Front, side and back of the machine (80KW)

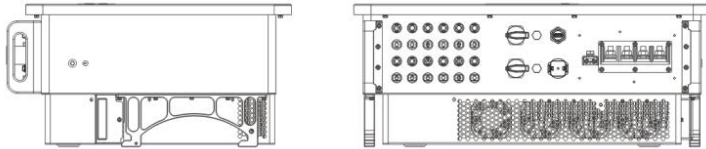
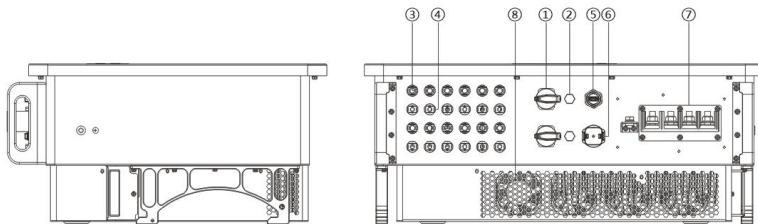

Figure 2-4 Bottom view of the machine (80KW)

## Function description of inverter box bottom



1. DC Switch	5. USB Port (for WIFI or GPRS communication)
2. Breather valve	6. COM Port (for RS485 communication)
3. DC positive poles connectors	7. AC output
4. DC negative poles connectors	8. Fans

Figure 2-5 Bottom view of SOFAR 60~80KTLX-G3

### ◆ Labels on the equipment

Note: label must NOT be hidden with objects and extraneous parts (rags, boxes, equipment, etc.); they must be cleaned regularly and kept visible at all times.

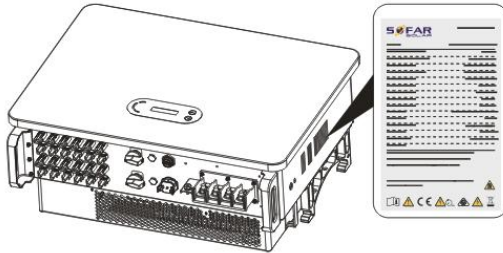

Figure 2-6 Product label

## 2.2. Function Description

DC power generated by PV arrays is filtered through Input Board then enter Power Board. Input Board also offer functions such as insulation impedance detection and input DC voltage/ current detection. DC power is converted to AC power by Power Board. AC power is filtered through Output Board then AC power is fed into the grid. Output Board also offer functions such as grid voltage/ output current detection, GFCI and output isolation relay. Control Board provides the auxiliary power, controls the operation state of inverter and shows the operation status by Display Board. Display Board displays fault code when inverter is abnormal operation conditions. At the same time, Control Board can trigger the replay to protect the internal components.

## Function Module

### A. Energy management unit

Remote control to start/ shunt down inverter through an external control.

### B. Feeding reactive power into the grid

The inverter is able to produce reactive power, thus to feed it into the grid through

the setting of the phase shift factor. Feed-in management can be controlled directly by the APP, or through a RS485 interface.(Optional)

#### **C. Limited the active power fed into grid**

If enable the limited of active power function, inverter can limit the amount of active power fed into the grid to the desired value (expressed as percentage).

#### **D. Self-power reduction when grid is over frequency**

If grid frequency is higher than the limited value, inverter will reduce the output power to ensure the grid stability.

#### **E. Data transmission**

Inverter can be monitored remotely through an USB stick logger(WIFI) or software Storage Monitor(optional) which is based on RS485 interface.

#### **F. Software update**

USB interface for uploading the firmware, remotely uploading is available through an USB stick logger(WIFI)

### **2.3. Electrical block diagram**

SOFAR 60~80KTLX-G3 has 12 DC input strings, 6 MPPT trackers to tracking the maximum power point, then converters the direct current of PV array to grid-compliant, three phase current and feeds in into the utility grid. Both DC and AC side has Surge Protection Device (SPD).

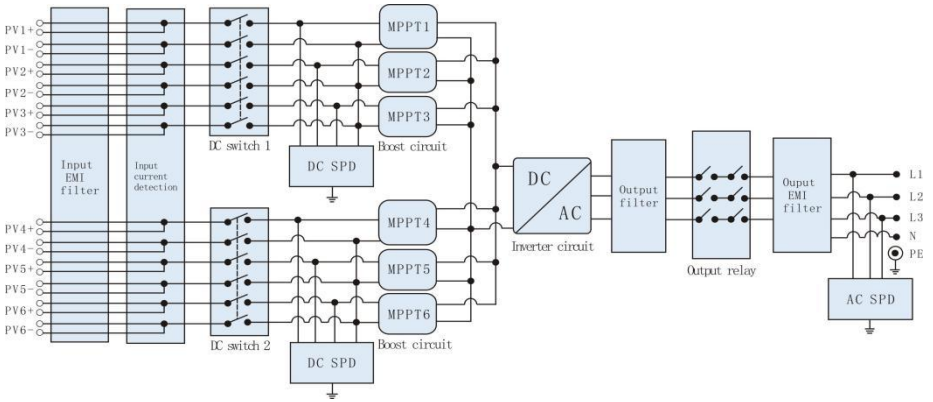

Figure 2-7 Main circuit structure

## 2.4. Efficiency curve



Figure 2-8 Power efficiency curve (take 80KW for example)

## 3. Inverter Storage

If inverter is not installing immediately, storage condition need meet below requirements:

- Place inverter into the original package and leave desiccant inside, sealed tight with taps.
- Keep the storage temperature around  $-40^{\circ}\text{C}\sim 70^{\circ}\text{C}$ , Relative humidity 5~95%, no condensation.

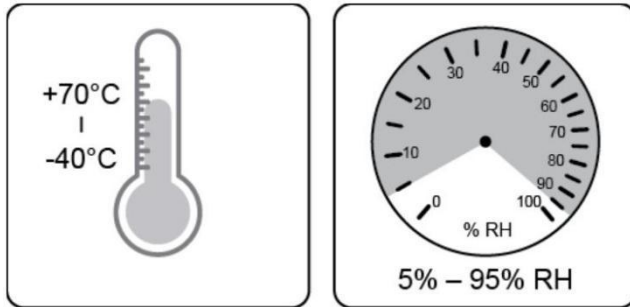





Figure 3-1 Storage temperature and humidity

- The maximum stacking layer number cannot exceed 2 layers.
- If the inverter be storage for more than half year, the inverter needs to be fully examined and tested by qualified service or technical personnel before using

# 4. Installation

## Outlines of this Chapter

This topic describes how to install this product, please read carefully before install.

	Do NOT install the product on flammable material. Do NOT store this product in potentially explosive atmospheres.
<b>Dangers</b>	
	The enclosure and heat sink will get hot during operation, please do not mount the product at a easy to reach location.
<b>Caution</b>	
	Consider the weight of this product when doing transport and moving. Choose an appropriate mounting position and surface.
<b>Attention</b>	At least two persons for installation.

### 4.1. Installation Process

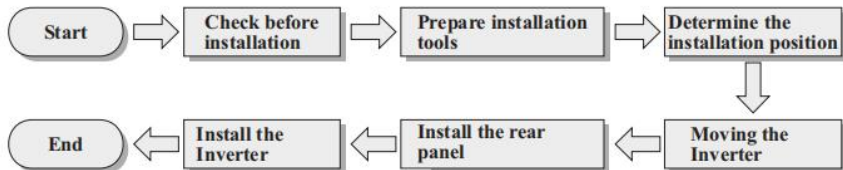

### 4.2. Checking Before Installation

#### Checking Outer Packing Materials







Before unpacking, please check the condition of the outer package materials if any damaged found, such as holes, cracks, please not unpack the product, contact your distributor immediately. Recommend installing the product within 24 hours after unpacking the package.





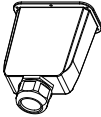

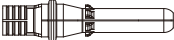
#### Checking Deliverable



After unpacking, please check according to following table, to see whether all the parts were included in the packing, please contact your distributor immediately if anything missing or damage.

Figure 4-1 Components and mechanical parts that inside the package

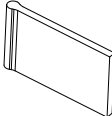

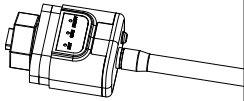

No	Pictures	Description	Quantity
1		SOFAR 60-80KTLX-G3	1 pcs
2		Rear Panel	1 pcs
3		AC waterproof cover	1pcs
4		M8*80 expansion bolt	4 pcs
5		PV+ metal pin	12 pcs
6		PV- metal pin	12 pcs
7		M4 cross screw (For locking the waterproof cover)	6 pcs(no these screws if AC connector has waterproof cover)
8		M6*30 Hexagon screws (For locking the Rear Panel)	2 pcs



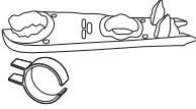
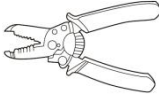

9		M6*12 Hexagon screws (For Grounding)	1 pcs
10		Manual	1 pcs
11		Warranty Card	1 pcs
12		Product Certification	1 pcs
13		Quality Certificate	1 pcs
14		AC terminal insulation partition	5 pcs
15		COM connector	1 pcs
16		USB WiFi Stick Logger	1 pcs

### 4.3. Tools

Prepare tools required for installation and electrical connection as following table:

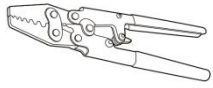
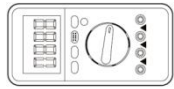
Figure 4-2 Installation tools

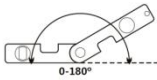
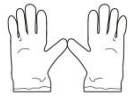
No	Tool	Description	Function
1		Hammer Drill Recommend drill @ 10mm	Used to drill holes on the wall
2		Screwdriver	Use to tighten and loosen screws when installing AC power cable Use to remove AC connectors from the product
3		Removal Tool	Remove PV Connector
4		Wire Stripper	Used to peel cable
5		Rubber Mallet	Used to hammer expansion bolts into holes
6		M6	M6 use to uninstall and install the front top cover and down cover

7		Socket Wrench	Fasten the cable and Install the expansion bolt
8		Crimping Tool	Use to crimp cable on grid side, load side and CT extensive cable
9		Multimeter	Check grounding cable, PV positive and negative pole
10		Marker	Mark signs
11		Measuring Tape	Measure distance
12		Level	Ensure the rear panel is properly installed
13		ESD gloves	Installer wear when installing product
14		Safety goggles	Installer wear when installing product
15		Mask	Installer wear when installing product

## 4.4. Determining the Installation Position

Select a appropriate location to install the product to make sure the inverter can work in a high efficiency condition. When selecting a location for the inverter, consider the following:

Note: Install vertical or backward tilt within 0-15°, Do not install forward or upside down!

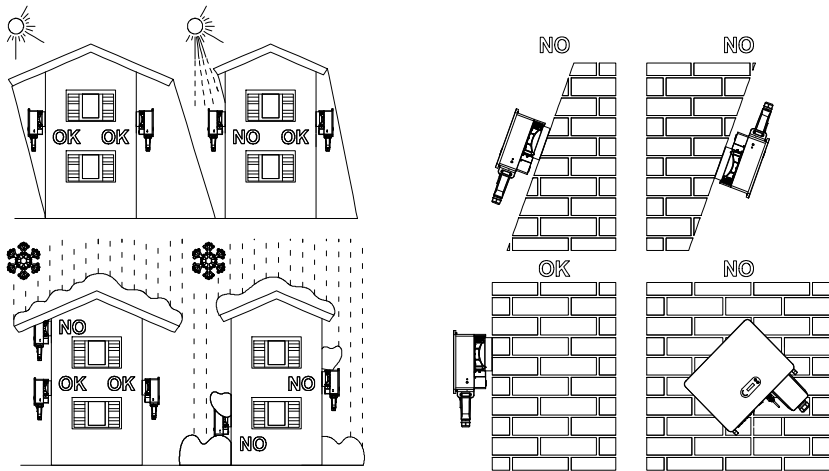
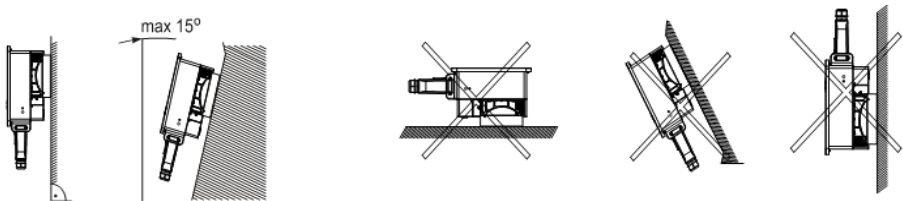

Figure 4-1 Installation Position Selection



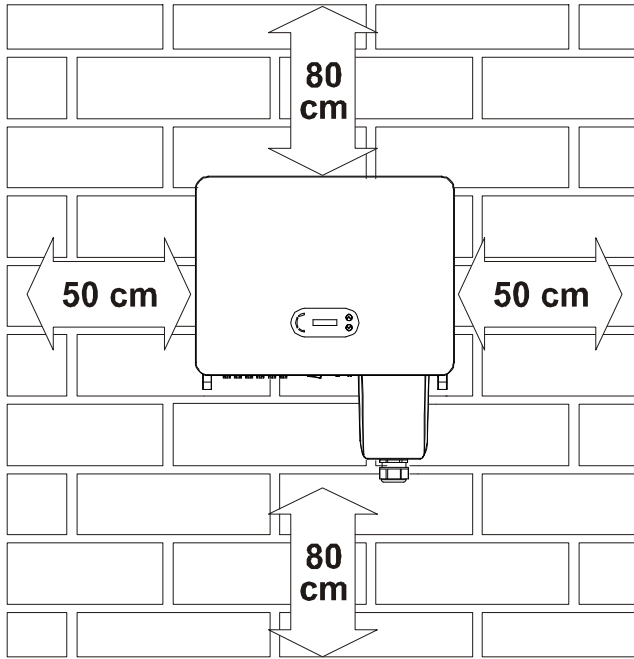

Figure 4-2 Clearance for single inverter

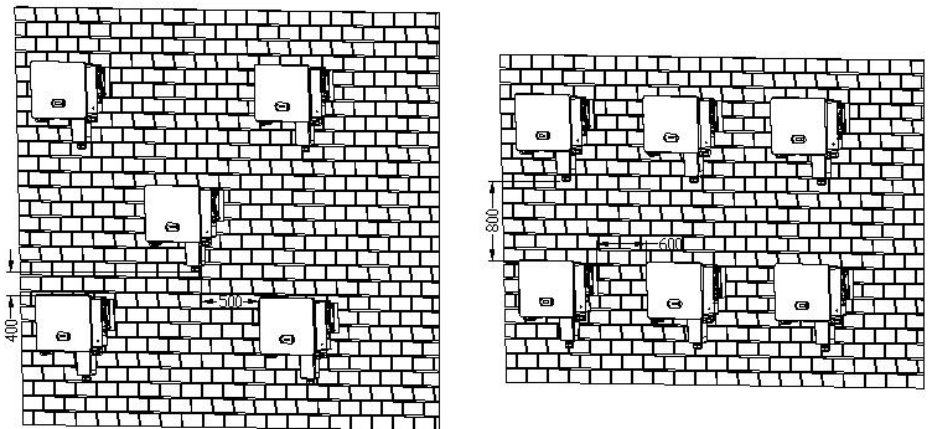

Figure 4-3 Clearance for multiple 60~80KTL-G3 inverters

## 4.5. Moving of inverter

Unload the inverter from package, horizontally move to the install position. When open the package, at least two operators insert the hands to the back of heat sink part.

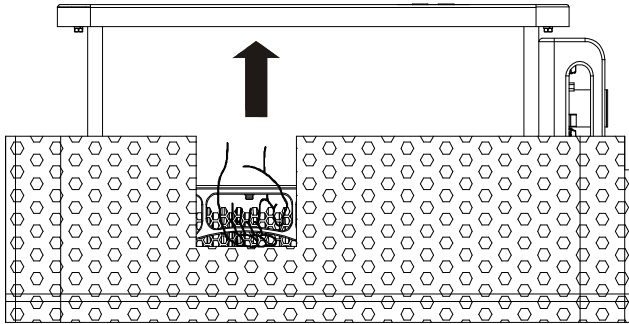

Figure 4-4 Move inverter from package(1)

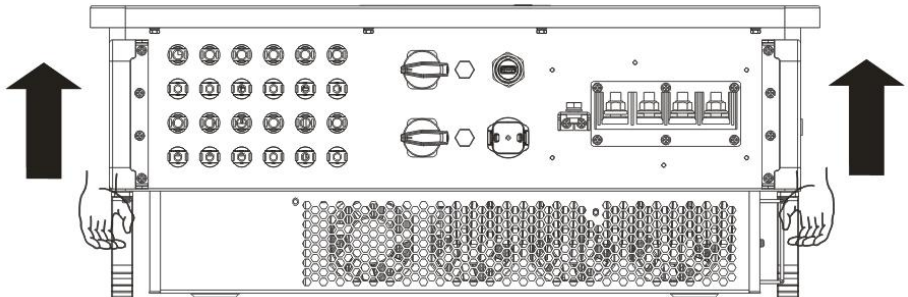



Figure 4-5 Move inverter from package(2)

	Inverter is heavy, attention to keep the balance when lift the inverter. Dropped while being transported may cause injuries.
	Do not put the inverter with wiring terminals contacting the floor because the power ports and signal ports are not designed to support the weight of the inverter
<b>Attention</b>	When place inverter on the floor, put it above foam or paper to avoid the damage of the shell of inverter.

## 4.6. Installation

### 4.6.1 Installed on wall:

**Step 1:** Placed the rear panel on the mounting wall, determine the mounting height of the bracket and mark the mounting poles accordingly. Drilling holes by using Hammer Drill, keep the hammer drill perpendicular to the wall and make sure the position of the holes should be suitable for the expansion bolts.(Note: Please find M8\*80 expansion bolt in the package)

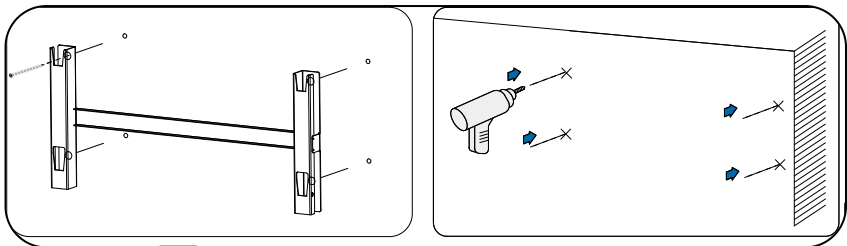

Figure 4-6 Drilling holes on the mounting wall

**Step 2:** Insert the expansion bolt vertically into the hole;

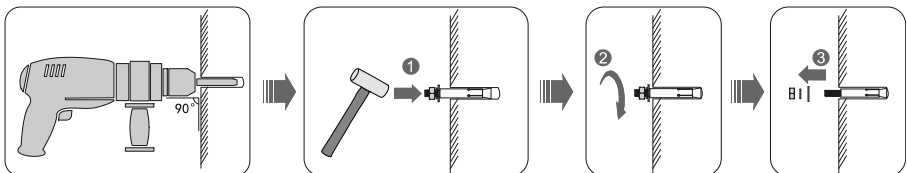



Figure 4-7 Screws into the holes

**Step 3:** Align the rear panel with the hole positions, fix the rear panels on the wall by tightening the expansion bolt with the nuts

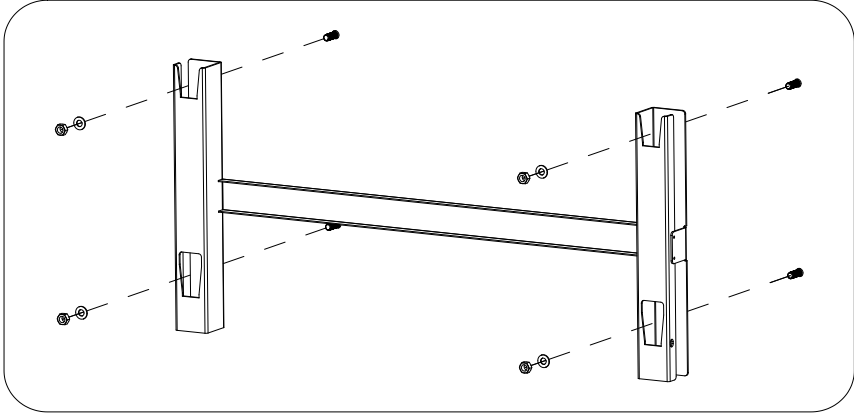

Figure 4-8 Install rear panel

**Step 4:** Lift the inverter and hang it on the rear panel, and fixing both side of inverter with M6 screw.

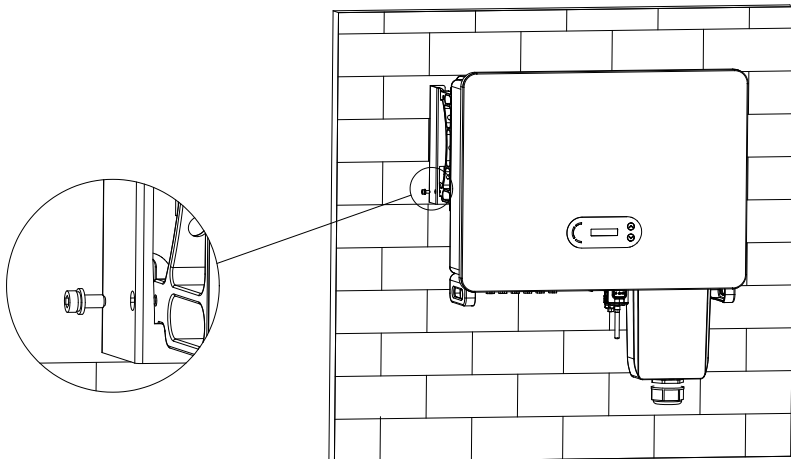

Figure 4-9 Fix inverter



# 5. Electrical Connection

## Outlines of this Chapter

This section introduces the electrical connection for the SOFAR 60~80KTLX-G3 on-grid inverter. Please read the information carefully, it may helpful to understand the grounding wiring, DC input connection, AC output connection and communication connection.

### Caution:

Before performing electrical connections, ensure the DC switch is OFF and AC circuit breaker is OFF. Waiting 5 minutes for the capacitor to be electrically discharged.

	Installation and maintenance should be done by certified electrical engineer
Attention	
	Before the electrical connection, use opaque material to cover the PV modules or disconnect PV string DC switch. PV arrays will produce dangerous voltage if it is exposure under sun
Danger	
	For SOFAR 60~80KTLX-G3 on-grid inverter, the open circuit voltage of PV strings should not exceed 1100V
Note	

The connected panel must meet the standard IEC61730A.

Model	Item	$I_{scPV}$ (Maximum)	Maximum output current
SOFAR 60KTLX-G3		6*50A	6*32A
SOFAR 80KTLX-G3		6*60A	6*40A
*SOFAR 70KTLX-G3		6*60A	6*40A

## 5.1. Electrical Connection

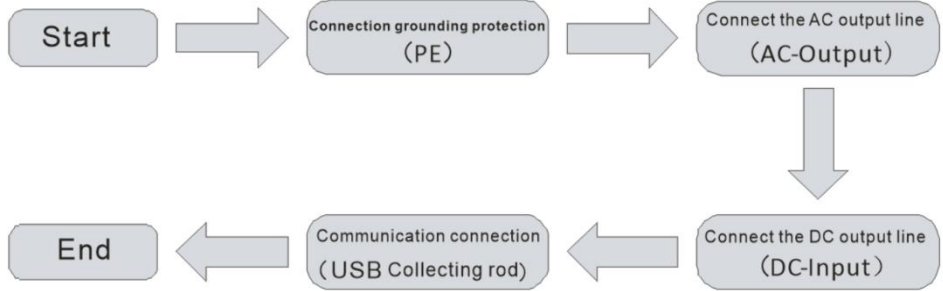

Figure 5-1 Flowchart for connecting cables to the inverter

## 5.2. Grounding Connection (PE)

Connect the inverter to the grounding electrode using ground cable.



Note

SOFAR 60-80KTLX-G3 is a transformerless inverter which requires the positive pole and negative pole of the PV array are NOT grounded. Otherwise, it will cause inverter failure. In the PV system, all non-current-carrying metal parts (such as mounting frame, combiner box enclosure, etc.) should be connected to earthed.

**Preparation:** prepare the grounding cable (The CSA of the cable at least  $10\text{mm}^2$  for copper wire or at least  $16\text{mm}^2$  for aluminium wire, recommend at least  $16\text{mm}^2$  yellow-green outdoor cable)

**Procedure:**

**Step 1:** Remove the insulation layer with an appropriate length using a wire stripper shown as figure 5-2.

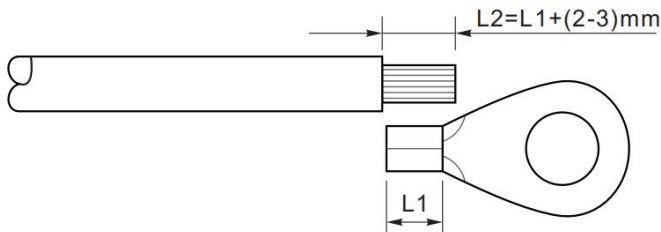

Figure 5-2 Grounding connection instruction (1)

Note: the length of L2 should 2~3mm higher than L1.

**Step 2:** Insert the exposed core wires into the OT terminal and crimp them by using a crimping tool, as shown as figure 5.3. Recommend using OT terminal: OT M6, Cable:  $\geq 6\text{mm}^2$ .

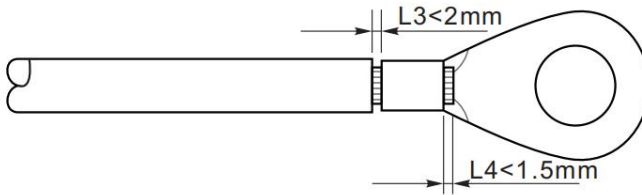

Figure 5-3 Grounding connection instruction (2)

**Note 1:** L3 is the length between the insulation layer of the ground cable and crimped part. L4 is the distance between the crimped part and core wires protruding from the crimped part.

**Note 2:** The cavity formed after crimping the conductor crimp strip shall wrap the core wires completely. The core wires shall contact the terminal closely.

**Step 3:** Tighten the OT terminal by using M6 screw. Recommend torque is 5-7N.m.

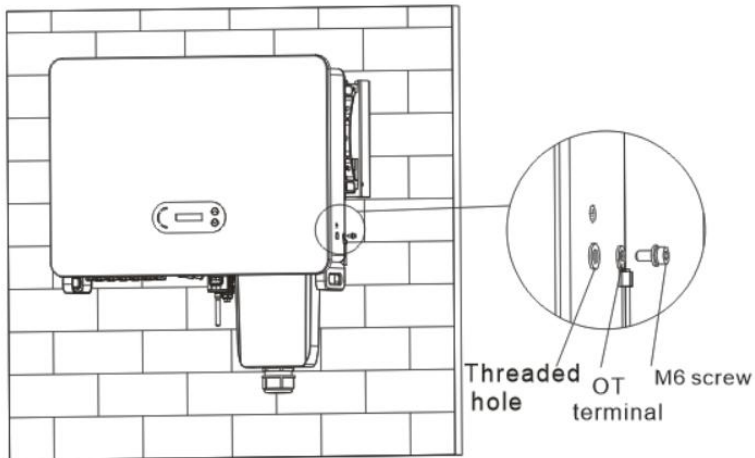



Figure 5-4 Inverter external grounding instruction diagram

### 5.3. Connect grid side of inverter(AC-Output)

SOFAR 60~80KTLX-G3 connect to utility grid by using AC power cable. The AC connection must meet the requirement of local grid operator.

	Ban multiple Inverters use one circuit breaker Ban connect loads between inverter and circuit breaker
<b>Caution</b>	

Must use five core outdoor cable, the recommend AC cable and Residual current breaker (RCB) as below table 5-1:

Model \ Item	L/N Cross section area of Cu or Al cable (mm <sup>2</sup> )	PE Cross section area of Cu or Al cable (mm <sup>2</sup> )	Muti-core outdoor cable diameter (mm)	AC Circuit Breaker specification
SOFAR 60KTLX-G3	50~70	16~25	≤28	120A/380V/3P I $\Delta$ N=0.3A
SOFAR 80KTLX-G3	70~95	16~25	≤28	150A/380V/3P I $\Delta$ N=0.3A
*SOFAR 70KTLX-G3	70~95	16~25	≤28	150A/380V/3P I $\Delta$ N=0.3A

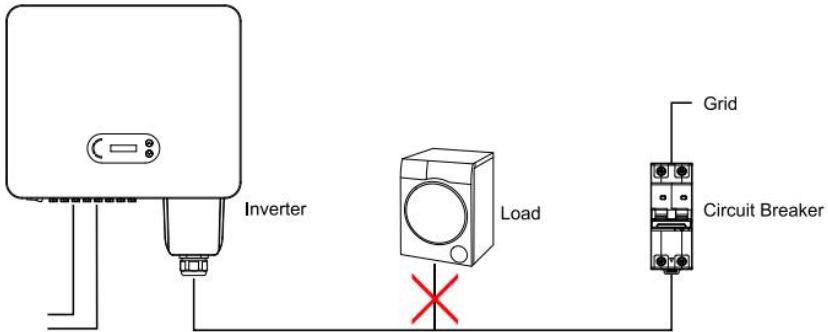

Figure 5-5 Incorrect connection between load and inverter

The resistance at connection point must less than  $2\Omega$ . In case to have a properly anti-islanding function, please choose the high-quality PV cable and ensure the power loss is less than 1%. Meanwhile, the inverter AC side to grid connection point must less than 100m. the relation between cable length, cross section area and power loss as below:

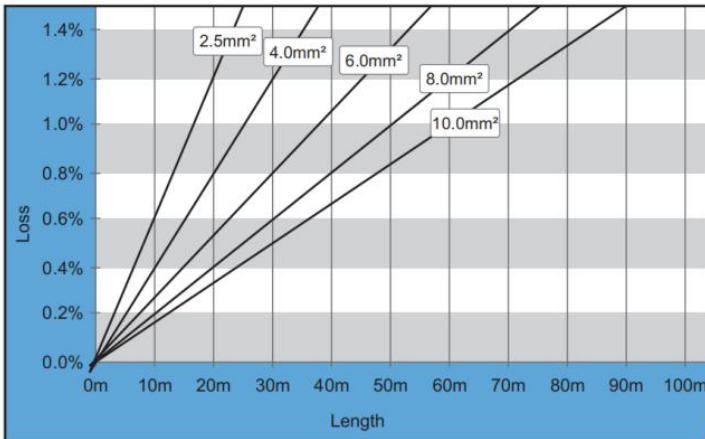

Figure 5-6 relation between cable length, cross section area and power loss

The AC output terminal of this product is equipped with high current 5-core

terminal block and customized AC output waterproof cover, which can meet the IP65 level requirements after installation. AC cable need customer self connect:

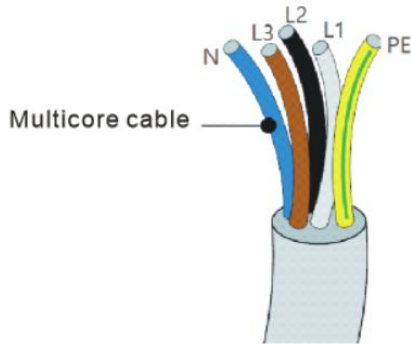
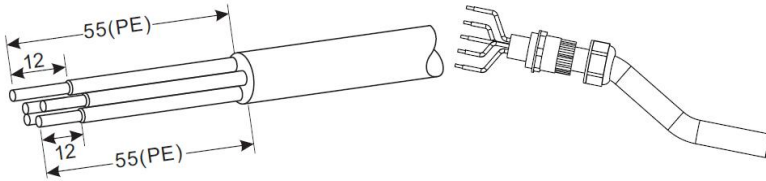

Figure 5-7 The equipment Multi-core Cable

Wiring Procedure as following:

**Step 1:** Remove the AC waterproof cover screw with a screwdriver, and take out the stopper in the PG waterproof joint.

**Step 2:** Select the appropriate cable diameter according to table 5-1, process the cable according to the following picture size requirements, and then pass through PG waterproof joint; The PE wire is connected to the grounding position of the container. External PE refer to Figure 5-4 Inverter external grounding instruction diagram.



R type terminal,  
RNBS14-6 (8awg).

Insulating sleeve,  
terminal shall not be exposed.

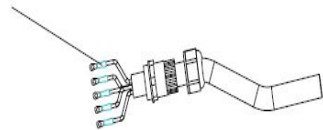
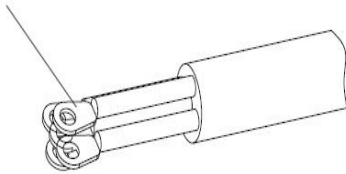

Figure 5-8 AC cable connection instruction diagram (1)

**Step 3:** After assembling the PG waterproof connector, connect the cable to the AC terminal block L1, L2, L3, N, PE contacts, and fasten them ( $8\sim 12\text{ N}\cdot\text{m}$ ). Take out the AC terminal insulation partition, clamp the AC output wiring cover and screw on the AC wiring terminal ( $2\sim 3\text{ N}\cdot\text{m}$ ).

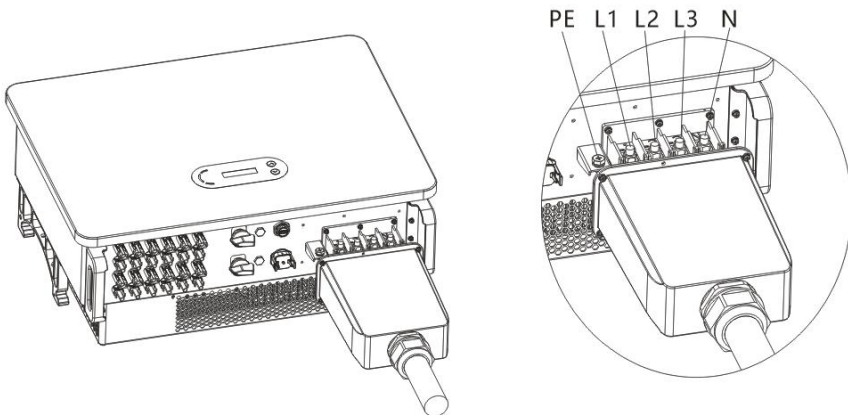
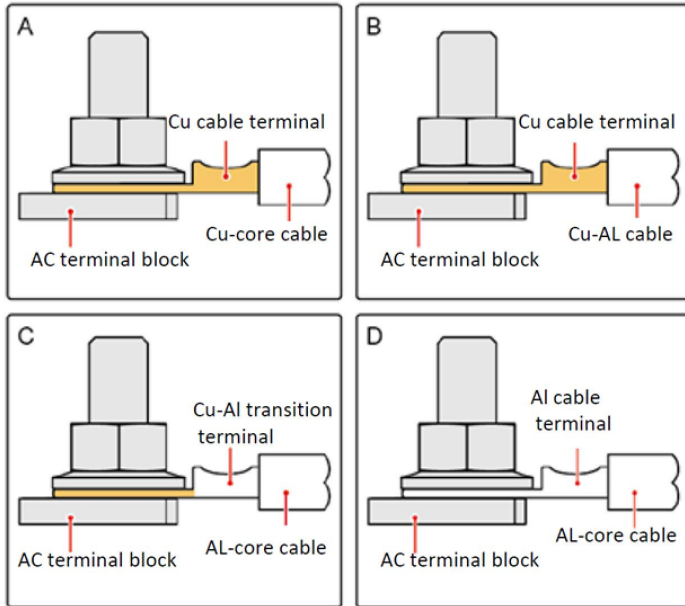

Figure 5-9 AC cable connection instruction diagram (2)



Note: Copper - aluminum conversion terminals are required when aluminum wires are used.



OT/DT Requirement for terminal connection

## 5.4. Connect PV side of inverter (DC-Input)

Figure 5-2 Recommend DC cable size (maximum tolerance voltage  $\geq 1100V$  PV cable)

Copper cable cross section area (mm <sup>2</sup> )	Cable OD (mm)
2.5~6.0	6.0~9.0

**Step 1:** Find the metal contact pins in the accessories bag, connect the cable according below diagram (1.Positive cable, 2. negative cable);

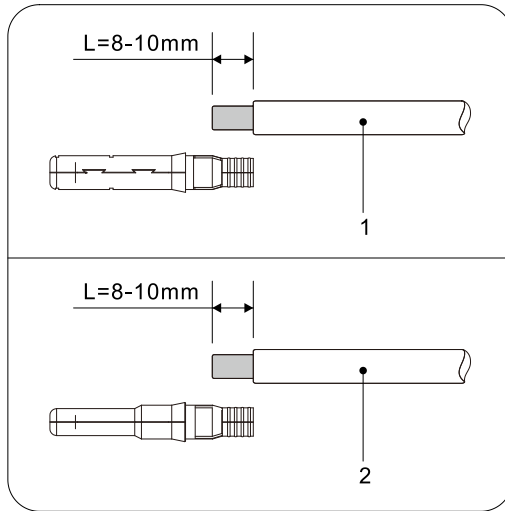

Figure 5-10 DC cable connection (1)

**Step 2:** Crimp the PV metal contact pin to the striped cable using a proper crimping pliers;

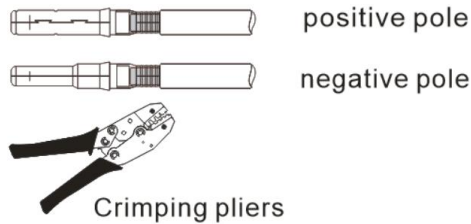

Figure 5-11 DC cable connection(2)

**Step 3:** Insert wire into the connector cap nut and assemble into the back of male or female plug, When you heard a “click”, the pin tact assembly is seated correctly. (3. Positive Connector, 4. negative connector);

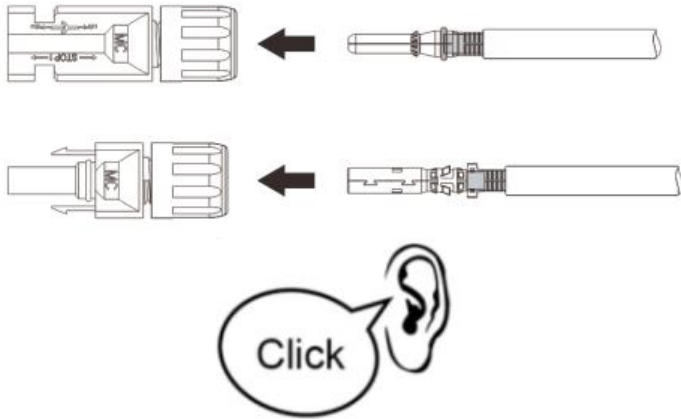

Figure 5-12 DC cable connection(3)

**Step 4:** Measure PV voltage of DC input with multimeter, verify DC input cable polar and connect DC connector with inverter until hearing a slight sound indicated connection succeed.

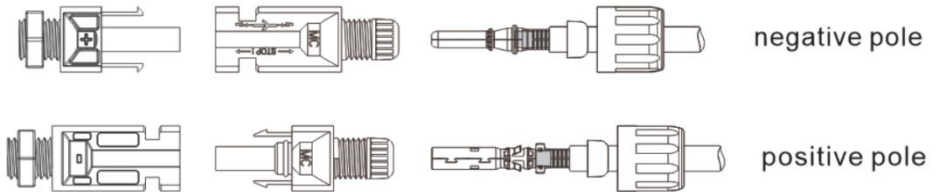

Figure 5-13 DC cable connection(4)

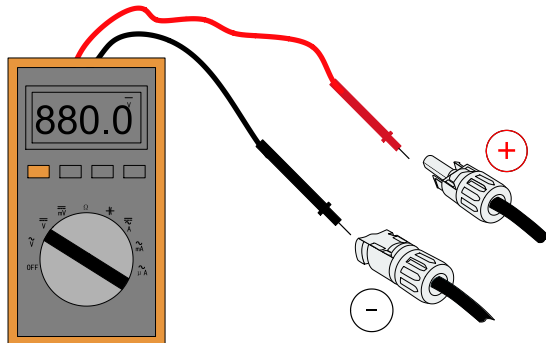



Figure 4-15 Use a multimeter to check the positive and negative electrodes

**Note : Please use multimeter to make sure the PV array positive pole and negative pole!**

Dealing : If need to remove the PV connector from inverter side, please use the Removal Tool as below diagram, move the connector gently.

 <b>Note</b>	<p>Before, moving the positive and negative connector, please make sure “DC Switch” is on OFF position.</p>
--	---

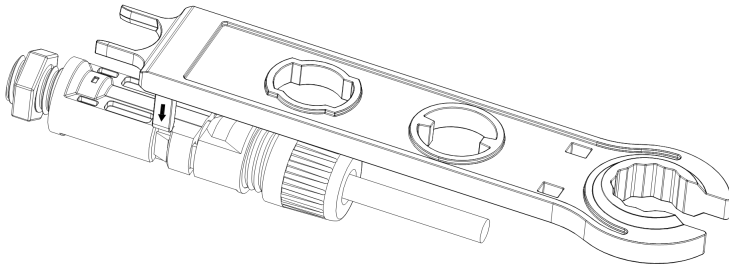

Figure 5-15 Removal DC connector

## 5.5. Communication Connection

**Note:** When layout the wiring diagram, please separate the communication wiring and power wiring in case the signal be affected.

SOFAR 60~80KTLX-G3 inverter has one USB Port and one COM Port, as shown in the following figure.

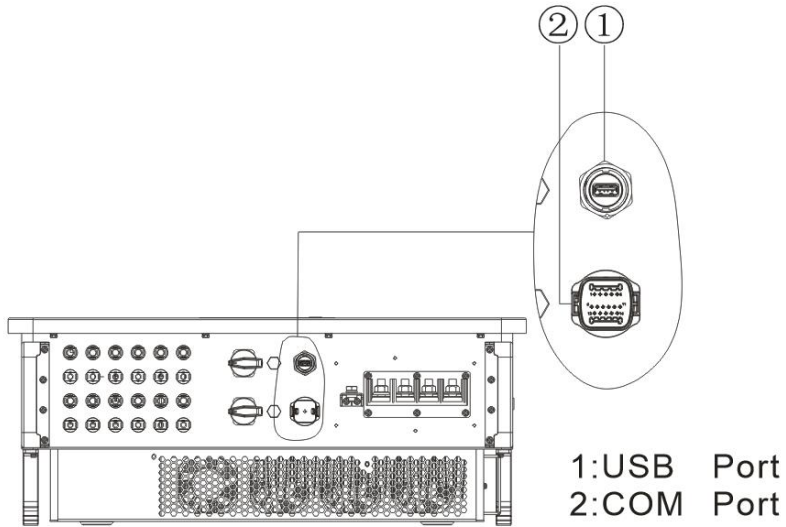

Figure 5-16 Communication connection Port

### 5.5.1 USB Port

Port Description:

USB port	USB flash disk access	Use for updating the software and fault recording
	USB stick logger (WIFI) access	Use for remote data acquisition and upgrading of inverter

Procedure:

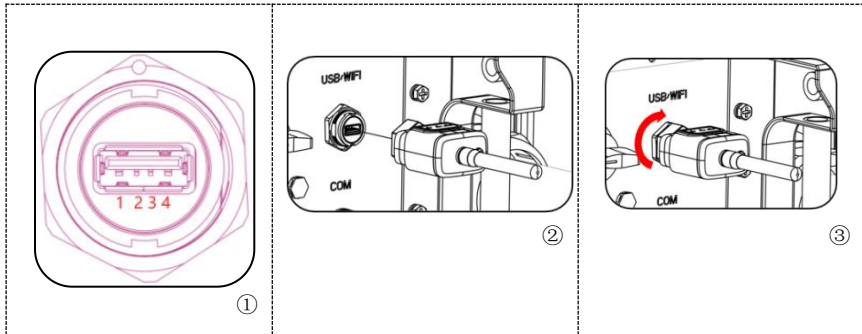

For details, please refer to the user manual of USB stick logger.

## 5.5.2 COM—Multi function communication port

Port Description:

PIN	Define	Function	Note
1	RS485A	RS485 signal+	Wire connection monitoring or multiple inverter monitoring
2	RS485A	RS485 signal+	
3	RS485B	RS485 signal-	
4	RS485B	RS485 signal-	
5	Electric meter RS485A	Electric meter RS485 signal+	DRMS port
6	Electric meter RS485B	Electric meter RS485 signal-	
7	GND.S	Communication ground	
8	DRM0	Remote shunt down	
9	DRM1/5		
10	DRM2/6		
11	DRM3/7		
12	DRM4/8		
13-16	Blank PIN	N/A	N/A

Procedure:

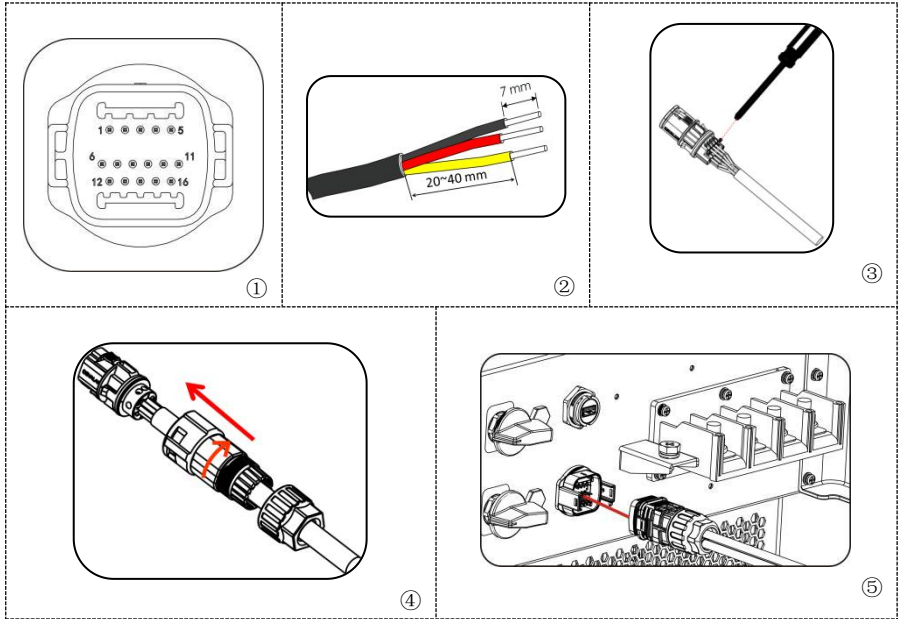

# 6. Commissioning of inverter

## Outlines this Chapter

Introduce SOFAR 60~80KTLX-G3 on-grid inverter safety inspection and start processing

### 6.1. Cable Connection Inspection

 <b>Attention</b>	<p>For first time operation (commissioning), should have a all-sided check. Especially, check the AC voltage and DC voltage are within the acceptable range</p>
---	---

AC grid connection

Use multimeter to confirm whether L1, L2, L3(live wire), N(neutral wire), PE(ground wire) and AC terminals are properly connected.

DC pv connection.

Use multimeter to confirm that positive pole and negative pole of PV strings, and the Voc of each string is lower than the inverter max DC input.

### 6.2. Start Inverter

**Step 1:** Turn ON the DC switch.

**Step 2:** Turn ON the AC circuit breaker.

When the DC power generated by the solar array is enough, the SOFAR 60~80KTLX-G3 inverter will start automatically. Screen showing“normal”indicates correct operation.

**NOTE 1:** Choose the correct country code. (refer to section 7.3 of this manual)

**NOTE 2:** Different distribution network operators in different countries have different requirements regarding grid connections of PV grid connected inverters.

Therefore, it's very important to make sure that you have selected the correct



country code according to requirements of local authority. Please consult qualified electrical engineer or personnel from electrical safety authorities about this.

Shenzhen SOFARSOLAR Co., Ltd. is not responsible for any consequences arising out of incorrect country code selection.

If the inverter indicates any fault, please refer to Section 8.1 of this manual —— trouble shooting for help.

# 7. Operation interface

## Outlines of this chapter

This section introduces the display, operation, buttons and LED indicator lights of SOFAR 60~80KTLX-G3 Inverter.

### 7.1. Operation and Display Panel

#### Buttons and Indicator lights

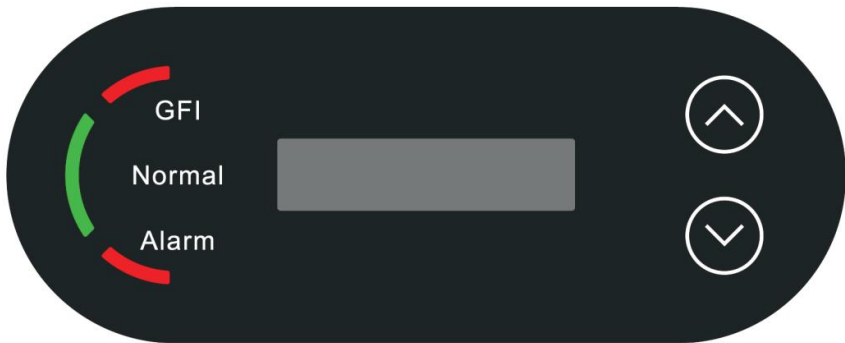

#### Indicator Lights:

“GFI” Red light ON = GFCI faulty

“Normal” Green light flashing = counting down or checking

“Normal” Green light ON = Normal

“Alarm” Red light ON= recoverable or unrecoverable faulty

#### Button:

“^” Short press UP button = go up

“^” Long press UP button = exit current interface

“v” Short press DOWN button = go down

“v” Long press DOWN button = enter current interface

## 7.2. Standard Interface

LCD interface indicated inverter status, alarm information, communication connection, PV input current and voltage, grid voltage, current and frequency, today generation, total generation.

Inverter working status, PV 1 input voltage and current

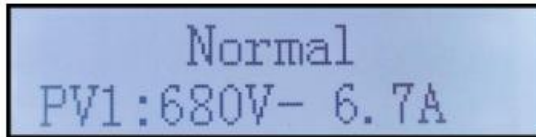

Normal  
PV1: 680V- 6.7A

Inverter working status, PV 2 input voltage and current

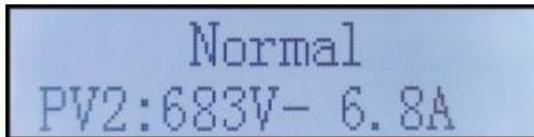

Normal  
PV2: 683V- 6.8A

Inverter working status, PV 3 input voltage and current

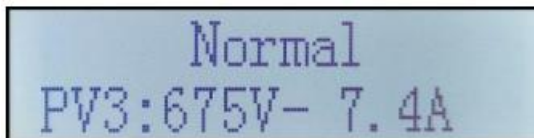

Normal  
PV3: 675V- 7.4A

Inverter working status, PV 4 input voltage and current

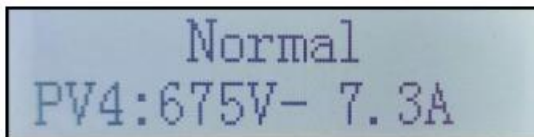

Normal  
PV4: 675V- 7.3A

Inverter working status, PV generated power

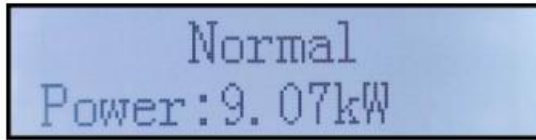

Normal  
Power: 9.07kW

Inverter working status, today generated electricity

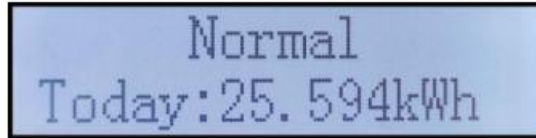

Normal  
Today: 25.594kWh

Inverter working status, total generated electricity

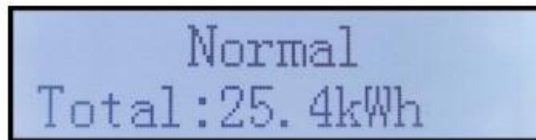

Normal  
Total: 25.4kWh

Inverter working status, grid voltage and current

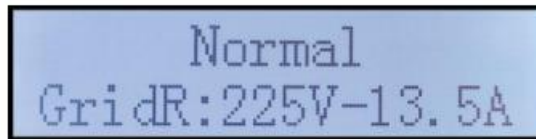

Normal  
GridR: 225V-13.5A

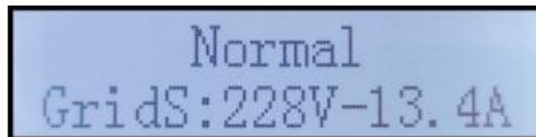

Normal  
GridS: 228V-13.4A

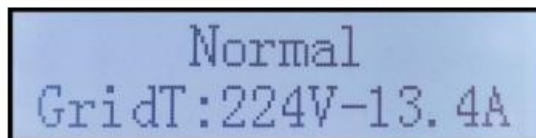

Normal  
GridT: 224V-13.4A

Inverter working status, grid voltage and frequency

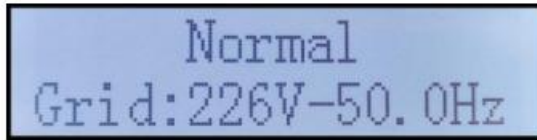

Normal  
Grid: 226V-50.0Hz

Inverter working status, USB status

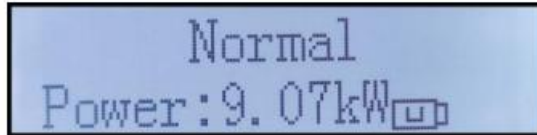

Normal  
Power: 9.07kW 

Inverter faulty alarm

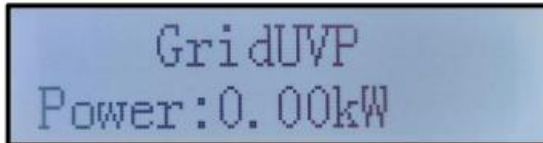

Grid UVP  
Power: 0.00kW

When control board successfully connected with communication board, the LCD display the current state of the inverter, display as shown in the figure below.

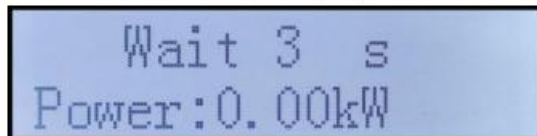

Wait 3 s  
Power: 0.00kW

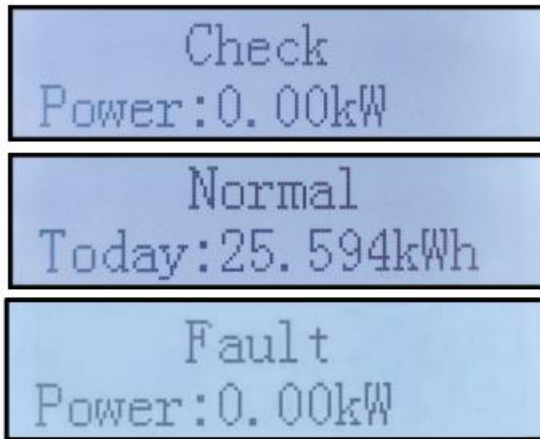

Inverter states includes: wait, check, normal and fault

**Wait:** Inverter is waiting to Check State when reconnect the system. In this state, grid voltage value is between the max and min limits and so on; If not, Inverter will go to Fault State or Permanent State.

**Check:** Inverter is checking isolation resistor, relays, and other safety requirements. It also does self-test to ensure inverter software and hardware are well functional. Inverter will go to Fault State or Permanent State if any error or fault occurs.

**Normal:** Inverter enter to Normal State, it is feeding power to the grid; inverter will go to Fault State or Permanent state if any error or fault occurs.

**Fault:** Fault State: Inverter has encountered recoverable error. It should recover if the errors disappear. If Fault State continues; please check the inverter according error code.

When the control board and communication board ARM connection fail, the LCD display interface as shown in the figure below.

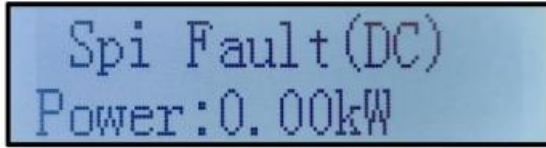

### 7.3. Main Interface

Long press the down button under standard interface to enter into main interface, Main interface including below information:

Normal	-----Long press DOWN button	
	1.Enter Setting	
	2.Event List	
	3.System Info	
	4.System Time	
	5.Software Update	

(A)Enter setting Interface as below:

1.Enter Setting	-----Long press DOWN button	
	1.Set time	9.Set Language
	2.Clear Energy	10.Set AntiReflux
	3.Clear Events	11.Logic Interface
	4.Set Safety Para	12.IV Curve Scan
	5.On-Off Control	13.Set Power Derate
	6.Set Energy	14.PCC Select
	7.Set Address	15.Reflux Mode
	8.Set Inputmode	

Long press the button to Enter the main interface of "1.Enter Setting" and long press to enter the setting menu. You can select the content you want to set by short pressing the button.

Note1: Some settings need to enter the password (the default password is 0001), when entering the password, short press to change the number, long press to confirm the current number, and long press after entering the correct password.If

"password error, try again" appears, you will need to re-enter the correct password.

### **1. Set Time**

Set the system time for the inverter.

### **2. Clear Energy**

Clean the inverter of the total power generation.

### **3. Clear Events**

Clean up the historical events recorded in the inverter.

### **4. Set Safety Para**

Long press button, enter interface, save the specific file into USB and insert USB into inverter communication port.

### **5. On-Off Control**

Inverter on-off local control.

### **6. Set Energy**

Set the total power generation. You can modify the total power generation through this option.

### **7. Set address**

Set the address (when you need to monitor multiple inverters simultaneously), Default 01.

### **8. Set Input mode**

SOFAR 60~80KTLX-G3 has 6 MPPTs, these MPPTs can work interdependently, or divided into parallel mode. User can change the setting according to the configuration.

### **9. Set Language**

Set the inverter display language.

### **10. Set AntiReflux**

Enable or disable Reflux. If disabled, the output will be the rated power. If enable, continue to set the Reflux power, the maximum power is the rated power. And continue to select PCC sampling points.

The reflux power value set by the anti-reflux function is the maximum power



value allowed to be transmitted to the grid.

**11. Logic interface**

Enable or disable logical interfaces. It is use for below standard Australia (AS4777), Europe General (50549), German(4105).

**12. IV Curve Scan**

Shadow scanning, when the component is blocked or abnormal, causing multiple power peaks, by enabling this function, the peak point of maximum power can be tracked.

**13. Set Power Derate**

Enable or disable the power derate function of the inverter, and set the derate ratio.

**14. PCC Select**

Select which way to sample power at the on-grid point.

**15. Reflux Mode**

Select reflux mode.

(B) Event List:

Event List is used to display the real-time event records, including the total number of events and each specific ID No. and happening time. User can enter Event List interface through main interface to check details of real-time event records, Event will be listed by the happening time, and recent events will be listed in the front. Please refer to below picture. Long press the button and short press the button to turn the page in standard interface, then enter into “2.Event List” interface.

2. Event List	
1. Current event	2. History event
Fault information	001 ID04 06150825 (Display the event sequence number, event ID number, and event occurrence time )

**(C) “SystemInfo” Interface as below**

<b>3.SystemInfo</b>	-----Long press DOWN button	
	<b>1.Inverter Type</b>	<b>11.Reflux Enable</b>
	<b>2.Serial Number</b>	<b>12.Reflux Power</b>
	<b>3.General Soft Version</b>	<b>13.DRM0</b>
	<b>4.General Hard Version</b>	<b>14.DRMn</b>
	<b>5.Country Code</b>	<b>15.MPPT Scan</b>
	<b>6.Safety Software Version</b>	<b>16.Force Control</b>
	<b>7.Safety Hardware Version</b>	<b>17.Power Derate</b>
	<b>8.Modbus Address</b>	<b>18.PCC Select</b>
	<b>9.Input Mode</b>	<b>19.Reflux Mode</b>
	<b>10.Remote State</b>	

The user enters the main menu by long pressing the DOWN button, short press and turns the page to select menu contents, then long press the button to enter "3. SystemInfo". Turning the page down can select the system information to view.

#### (D)System Time

Long press the button and short press the button to turn the page in the standard user interface to enter into "4.Display Time",then long press the button to display the current system time.

#### (E)Software Update

Enters the main menu, short press to select "5. Software Update", then long press the button to enter. Short press the UP or DOWN button to enter the number, long press DOWN button to confirm the number, enter the password.

User can update software by USB flash drive , SOFARSOLAR will provide the new update software named 'firmware' for user if it is necessary. The user needs to copy the upgrade file to the USB flash drive.

## 7.4. Updating Inverter Software

SOFAR 60~80KTLX-G3 inverter offer software upgrade via USB flash drive to maximize inverter's performance and avoid inverter operation error caused by software bugs.

**Step 1:** Turn off AC circuit breaker and DC switch, remove the communication board cover as below figure. If the RS485 line has been connected, please release

the waterproof nut first and make sure the communication line is no longer the force. Then remove the waterproof cover.

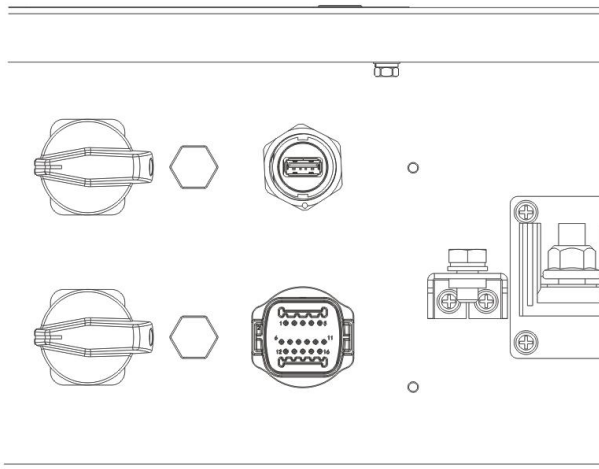

Figure 7-1 The diagram of removed communication waterproof cover

**Step 2:** Insert USB into computer;

**Step 3:** SOFARSOLAR service team will send the software code to user. The upgrade file should be placed in a file named "firmware".

**Step 4:** Insert USB drive into the USB port of inverter;

**Step 5:** Then turn on DC switch. Until the screen shows recoverable fault (since the ac breaker is still off, the machine does not detect the power grid, so recoverable fault will be displayed)

**Step 6:** Enter into the online upgrade to the main menu"5.Software Update" in the LCD display program.

**Step 7:** Input the password, if password is correct, and then begin the update process, the original password is 0715.

**Step 8:** System update main DSP, slave DSP and ARM in turns automatically. If main DSP update success, the LCD will display"Update DSP1 Success"; If slave DSP update success, the LCD will display"Update DSP2 Success".When the ARM

update success, the system will start initialization, the LED will display "System is starting...". When the initialization is finished, the LED screen shows recoverable fault (since the ac breaker is still off, the machine does not detect the power grid, so recoverable fault will be displayed)

**Step 9:** After the update is completed, turn off the DC breaker, wait for the LCD screen to extinguish, then recover the communication waterproof and then turn on the DC breaker and AC breaker again, the inverter will enter the running state.

**Note:** If the screen shows "Communication fail", "xxx Update fail", "xxx file error". This means the software upgrade failed. Please turn off the DC switch, waiting for 5 minutes (Discharge the capacitance), then continue to update from step 5.

# 8. Trouble shooting and maintenance

## 8.1. Troubleshooting

This section describes the potential errors for this product. Please read carefully for the following tips when doing the troubleshooting:

- 1) Check the warning message or faulty codes on the inverter information panel
- 2) If not any error code display on the panel, please check the following lists:
  - Is inverter be installed in a clean, dry, ventilated environment?
  - Is the DC switch turn off?
  - Are the cable cross section area and length meet the requirement?
  - Are the input and output connection and wiring in good condition?
  - Are the configuration settings correctly for the particular installation?

This section contains the potential errors of SOFAR 60~80KTLX-G3 on-grid inverter, resolution steps, and provide users with troubleshooting methods and tips. Help users to identify and solve the common faults of the series inverter.

The process to check the event list can refers to Manual Chapter 7.3 (B)

Figure 8-1 Even list

Code	Name	Description	Solution
ID001	GridOVP	The grid voltage is too high	If the alarm occurs occasionally, the possible cause is that the electric grid is abnormal occasionally. Inverter will automatically return to normal operating status when the electric grid's back to normal.
ID002	GridUVP	The grid voltage is too low	
ID003	GridOFP	The grid frequency is too high	
ID004	GridUFP	The grid frequency is too low	If the alarm occurs frequently, check whether the grid voltage/frequency is within the acceptable range. If yes, please check the AC circuit breaker and AC wiring of the inverter. If the grid voltage/frequency is NOT within the acceptable range and AC wiring is correct, but the alarm occurs repeatedly, contact SOFARSOLAR

			technical support to change the grid over-voltage, under-voltage, over-frequency, under-frequency protection points after obtaining approval from the local electrical grid operator.
ID005	GFCIFault	Charge Leakage Fault	If the fault occurs occasionally, the possible cause is that the external circuits are abnormal occasionally. inverter automatically returns to normal operating status after the fault is rectified. If the fault occurs frequently and lasts a long time, check whether the insulation resistance between the PV array and earth(ground) is too low, then check the insulation conditions of PV cable.
ID006	OVRT	OVRT function is faulty	Internal faults of inverter, switch OFF inverter, wait for 5 minutes, then switch ON inverter. Check whether the problem is solved. If not, please contact SOFARSOLAR technical support.
ID007	LVRT	LVRT function is faulty	
ID008	IslandFault	Island protection error	
ID009	GridOVPIstant1	Transient overvoltage of grid voltage 1	
ID010	GridOVPIstant2	Transient overvoltage of grid voltage 2	
ID011	VGridLineFault	Power grid line voltage error	
ID012	InvVoltFault	Inverter voltage error	Internal faults of inverter, switch OFF inverter, wait for 5 minutes, then switch ON inverter. Check whether the problem is solved. If not, please contact SOFARSOLAR technical support.
ID017	HwADerrGrid	Power grid current sampling error	
ID018	HwADerrDCI(AC)	Wrong sampling of dc component of grid current	
ID019	HwADerrVGrid(DC)	Power grid voltage sampling error (DC)	
ID020	HwADerrVGrid(AC)	Power grid voltage sampling error (AC)	
ID021	HwGFCIFault(DC)	Leakage current sampling error(DC)	
ID022	HwGFCIFault(AC)	Leakage current sampling error(AC)	
ID024	HwADerrIdc	Dc input current sampling error	

ID029	ConsistentGFI	Leakage current consistency error	
ID030	ConsistentVgrid	Grid voltage consistency error	
ID031	ConsistentDCI	DCI consistency error	
ID033	SpiCommFault(DC)	SPI communication error (DC)	
ID034	SpiCommFault(AC)	SPI communication error (AC)	
ID035	SChip_Fault	Chip error (DC)	
ID036	MChip_Fault	Chip error (AC)	
ID037	HwAuxPowerFault	Auxiliary power error	
ID041	RelayFail	Relay detection failure	Internal faults of inverter, switch OFF inverter, wait for 5 minutes, then switch ON inverter. Check whether the problem is solved. If not, please contact SOFARSOLAR technical support.
ID042	IsoFault	Low insulation impedance	Check the insulation resistance between the photovoltaic array and ground (ground), if there is a short circuit, the fault should be repaired in time. If not solved, please contact SOFARSOLAR technical support.
ID043	PEConnectFault	Ground fault	Check ac output PE wire for grounding. If not solved, please contact SOFARSOLAR technical support.
ID044	PvConfigError	Error setting input mode	Check the input mode (parallel/independent mode) Settings for the inverter. If not solved, please contact SOFARSOLAR technical support.
ID045	CDTisconnect	CT Fault	Please check the wiring of input, output and communication according to the user's manual. If the use method is not ruled out, please contact SOFARSOLAR technical support..
ID046	ReversalConnection	Input reverse connection error	
ID047	ParallelFault	ParallelFault	
ID048	SNTypeFault	SN doesn't match Type	It is internal fault of inverter.
ID049	Reserved	Reserved	
ID050	TempErrHeatSink1	Radiator 1 temperature protection	Ensure the installation position and installation method meet the requirements of this user manual. Check whether the ambient temperature of the installation position exceeds the upper limit. If yes, improve ventilation to decrease the temperature. Check whether the inverter has dust and dust, whether there are foreign matters
ID051	Reserved	Reserved	
ID052	Reserved	Reserved	
ID053	Reserved	Reserved	
ID054	Reserved	Reserved	

ID055	Reserved	Reserved	blocking the fan at the air inlet. If so, please improve the ventilation and heat dissipation of the environment. It is recommended that the inverter should be cleaned once every half year or one year.
ID057	TempErrEnv1	Ambient temperature 1 protection	
ID058	Reserved	Reserved	
ID059	TempErrInv1	Module 1 temperature protection	
ID060	Reserved	Reserved	
ID061	Reserved	Reserved	
ID065	BusRmsUnbalance	Unbalanced bus voltage RMS	Internal faults of inverter, switch OFF inverter, wait for 5 minutes, then switch ON inverter. Check whether the problem is solved. If not, please contact SOFARSOLAR technical support.
ID066	BusInstUnbalance	The transient value of bus voltage is unbalanced	
ID067	BusUVP	Bus undervoltage during grid connection	If the configuration of the PV array is correct, could be the sun irradiation is too low. Once sun irradiation back to normal, inverter will work back normal
ID068	BusZVP	Bus voltage low	Internal faults of inverter, switch OFF inverter, wait for 5 minutes, then switch ON inverter. Check whether the problem is solved. If not, please contact SOFARSOLAR technical support.
ID069	PVOVP	PV over-voltage	
ID070	Reserved	Reserved	
ID071	LLCBusOVP	LLC BUS overvoltage protection	
ID072	SwBusRmsOVP	Inverter bus voltage RMS software overvoltage	
ID073	SwBusInstantOVP	Inverter bus voltage instantaneous value software overvoltage	
ID081	Reserved	Reserved	
ID082	DciOCP	Dci overcurrent protection	
ID083	SwOCPInstant	Output instantaneous current protection	
ID084	SwBuckBoostOCP	BuckBoost software flow	
ID085	SwAcRmsOCP	Output effective value current protection	
ID086	SwPvOCPInstant	PV overcurrent software protection	
ID087	IpvUnbalance	PV flows in uneven	



		parallel	
ID088	IacUnbalance	Unbalanced output current	
ID097	HwLLCBusOVP	LLC hardware overvoltage	
ID098	HwBusOVP	Inverter bus hardware overvoltage	
ID099	HwBuckBoostOCP	BuckBoosthardware overflows	
ID100	Reserved	Reserved	
ID102	HwPVOCP	PV hardware overflows	
ID103	HwACOCP	Ac output hardware overflows	
ID105	MeterCommFault	Meters communication fault	Internal faults of inverter, switch OFF inverter, wait for 5 minutes, then switch ON inverter. Check whether the problem is solved.
ID106	SNMachineFault	Serial number model error	If not, please contact SOFARSOLAR technical support.
ID110	Overload1	Reserved	
ID111	Overload2	Reserved	
ID112	Overload3	Reserved	
ID113	OverTempDerating	Overtemperature derating	Ensure the installation position and installation method meet the requirements of this user manual. Check whether the ambient temperature of the installation position exceeds the upper limit. If yes, improve ventilation to decrease the temperature. Check whether the inverter has dust and dust, whether there are foreign matters blocking the fan at the air inlet. If so, please improve the ventilation and heat dissipation of the environment. It is recommended that the inverter should be cleaned once every half year or one year.
ID114	FreqDerating	Frequency derating	If it occurs frequently, please check whether the grid voltage and grid frequency are within the allowable range of the inverter; if not, please contact the customer service of SOFARSOLAR; if yes, please check whether the connection between the circuit breaker at the AC side and the output cable is normal; if the grid voltage and grid frequency are within the allowable range of the inverter, and the AC side wiring is confirmed to be correct, the alarm still appears frequently With the approval of the local power operator, please
ID115	FreqLoading	Frequency loading	
ID116	VoltDerating	Voltage derating	
ID117	VoltLoading	Voltage loading	
ID121	SpdFail(DC)	Lightning protection fault(DC)	

ID122	SpdFail(AC)	Lightning protection fault(AC)	contact the customer service to modify the protection points of over / under voltage and over / under frequency of inverter grid.
ID124	Reserved	Reserved	
ID125	Reserved	Reserved	
ID129	unrecoverHw AcOCP	Output hardware overcurrent permanent failure	Internal faults of inverter, switch OFF inverter, wait for 5 minutes, then switch ON inverter. Check whether the problem is solved. If not, please contact SOFARSOLAR technical support.
ID130	unrecoverBus OVP	Permanent Bus overvoltage failure	
ID131	unrecoverHw BusOVP	Busovervoltage hardware permanent fault	
ID132	unrecoverIpv Unbalance	PV unbalance current permanent fault	
ID134	unrecoverAc OCPInstant	Output transient overcurrent permanent failure	
ID135	unrecoverIac Unbalance	Output current imbalance permanent fault	
ID137	unrecoverPv ConfigError	Input mode setting error permanent failure	
ID138	unrecoverPV OCPInstant	Input overcurrent permanent fault	Internal faults of inverter, switch OFF inverter, wait for 5 minutes, then switch ON inverter. Check whether the problem is solved. If not, please contact SOFARSOLAR technical support.
ID139	unrecoverHw PVOCP	Input hardware overcurrent permanent failure	
ID140	unrecoverRel ayFail	Relay permanent fault	
ID141	unrecoverVb usUnbalance	Bus Unbalanced permanent fault	
ID142	LightningProt ectionFaultD C	DC SPD failure	
ID143	LightningProt ectionFaultA C	AC SPD failure	
ID145	USBFault	USB fault	Internal faults of inverter, switch OFF inverter, wait for 5 minutes, then switch ON inverter. Check whether the problem is solved. If not, please contact SOFARSOLAR technical support.
ID146	WifiFault	Wifi fault	
ID147	BluetoothFau lt	Bluetooth fault	
ID148	RTCFault	RTC clock failure	
ID149	CommEPR	Communication	

	OMFault	board EEPROM error	
ID150	FlashFault	Communication board FLASH error	
ID152	SafetyVerFault	The software version is inconsistent with the safety version	
ID153	SciCommLoss(DC)	SCI communication error (DC)	
ID154	SciCommLoss(AC)	SCI communication error (AC)	
ID155	SciCommLoss(Fuse)	SCI communication error (Fuse)	
ID156	SoftVerError	Inconsistent software versions	
ID161	ForceShutdown	Force shutdown	Remote control enables. If it is not controlled by yourself, switch OFF inverter, wait for 5 minutes, then switch ON inverter. Check whether the problem is solved. If not, please contact SOFARSOLAR technical support.
ID162	RemoteShutdown	Remote shutdown	
ID163	Drms0Shutdown	Drms0 shutdown	
ID165	RemoteDerating	Remote derating	Inverter shows ID83 when remote derating. If no one operate this function, please check the connection (I/O) according to chapter 5.5
ID166	LogicInterfaceDerating	Logic interface derating	
ID167	AlarmAntiReflux	Anti refluxderating	
ID169	FanFault1	Fan 1 fault	Check whether the inverter has dust and dust, whether there are foreign matters blocking the fan at the air inlet. If so, please improve the ventilation and heat dissipation of the environment. It is recommended that the inverter should be cleaned once every half year or one year.
ID170	FanFault2	Fan 2fault	
ID171	FanFault3	Fan 3 fault	
ID172	FanFault4	Fan 4 fault	
ID173	FanFault5	Fan 5 fault	
ID174	FanFault6	Fan 6 fault	
ID193-ID224	StringFuse_Fault0-31	String fuse open circuit alarm	
ID225-ID240	Reserved	Reserved	/

Note: the above table is our general fault ID list, all fault IDs of this inverter can be found in the above table.

## 8.2. Maintenance

✧ Ensure that the heat sink of the inverter is not covered by dust. It is recommended that you maintain the inverter half a year to once a year (depending on the dust content in the local environment).

### ✧ **Inverter cleaning**

Please clean the inverter with an air blower, a dry & soft cloth or a soft bristle brush. Do NOT clean the inverter with water, corrosive chemicals, detergent, etc.

### ✧ **Heat sink cleaning**

For the long-term proper operation of inverters, ensure there is enough space around the heat sink for ventilation, check the heat sink for blockage (dust, snow, etc.) and clean them if they exist. Please clean the heat sink with an air blower, a dry & soft cloth or a soft bristle brush. Do NOT clean the heat sink with water, corrosive chemicals, detergent, etc.

### ✧ **Fan cleaning**

For inverter SOFAR 60~80KTLX-G3 with fans, please check if inverter have abnormal sound when inverter is operating. Check if fan on cracks, replace a new fan when necessary. Refers to below section.

## 8.3. Fan Maintenance

For SOFAR 60~80KTLX-G3 series inverter with fans, if fan is broken or not working properly may cause inverter heat dissipation issue and effect the working efficiency of inverter. Thus, fans need to have regularly cleaning and maintain, details operating as below:

Step 1: Turn off the inverter, check the wiring side to ensure all electrical connection of inverter is turn off ;

Step 2: Loosen the screws connecting the fan fixing plate on the right side to the backplane, remove the waterproof connector of the fan cable, and remove the fan fixing plate.

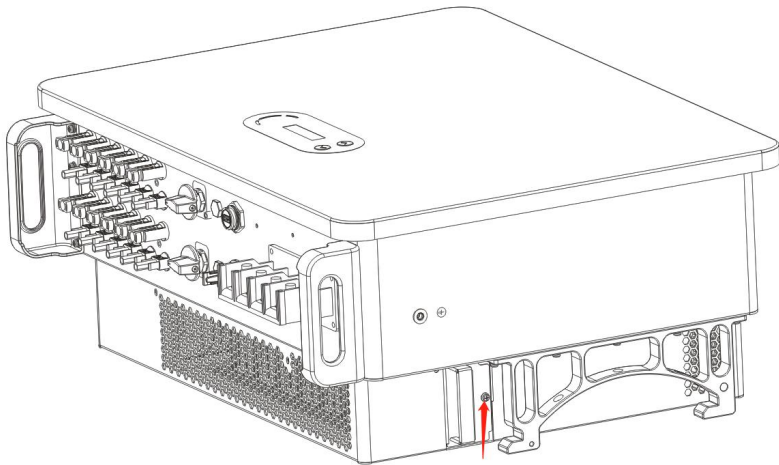

Figure 8-1 Remove one screw from the fan fixing plate

**Step 3:** Remove the screws from the fan and remove the fan completely.

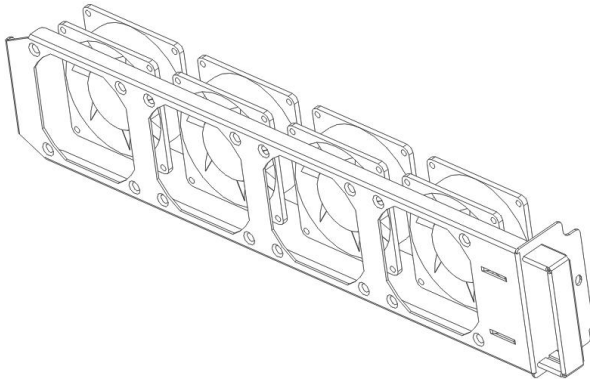

Figure 8-2 remove the fan and protective cover

**Step 4:** Use a soft brush to clean the fan. If it is damaged, please replace it in time;

**Step 5:** Re-install the inverter according to the above steps.

# 9. Technical Data

## Outlines of this Chapter

This chapter outline the SOFAR 60~80KTLX-G3 model type and technical parameters.

### 9.1. Technical Data List

Data sheet	SOFAR 60KTLX-G3	*SOFAR 70KTLX-G3	SOFAR 80KTLX-G3
Input (DC)			
Recommended Max. PV input power (Wp)	90000Wp	105000Wp	120000Wp
Number of MPP trackers	6		
Number for DC input	12		
Max. Input voltage	1100V		
Start-up voltage	200V		
Rated input voltage	620V	620V	620V
MPPT operating voltage range	180~1000V		
Full power MPPT voltage range(V)	550~800V	550~800V	550~800V
Max. Input MPPT current(A)	6*32A	6*40A	6*40A
Max. Input short circuit current	6*50A	6*60A	6*60A
Output(AC)			
Rated power(W)	60000W	70000W	80000W

Max. AC power(VA)	66000VA	77000VA	88000VA
Rated output current	86.9A	101.4A	115.9A
Max. Output current	100A	116.7A	133.3A
Nominal grid voltage	3/N/PE, 230/400Vac		
Grid voltage range	310Vac-480Vac (According to local standard)		
Nominal frequency	50 / 60Hz		
Grid frequency range	45Hz-55Hz/54Hz-66Hz (According to local standard)		
Active power adjustable range	0~100%		
THDi(current)	<3%		
Power factor	1 default (+/-0.8 adjustable )		
<b>Perfomance</b>			
Max. efficiency	98.7%		
European weighted efficiency	98.2%		
<b>Protection</b>			
DC reverse polarity protect	Yes		
Anti-islanding protection	Yes		
Leakage current protection	Yes		
Ground fault monitoring	Yes		
PV-array string fault monitoring	Yes		
Anti reverse power function	Yes		
DC switch	Yes		
PID protection	Optional		

AFCI protection	Optional
Input/output SPD	PV:Type II (Standard) ,Type I Optional; AC:Type II (Standard) ,Type I Optional
Communication	
Communication	RS485/USB/Bluetooth, Optional:WiFi/4G /PLC
General Data	
Ambient temperature range	-30℃~+60℃
Self-consumption during night	<2W
Topology	Transformerless
Degree of protection	IP66
Allowable relative humidity range	0~100%
Max. Operating altitude	4000m
Weight	50kg
Cooling	Fan
Dimension	687*561*275mm
Display	LCD
Standard warranty	5 years ( Extension available )
Standard	
EMC	EN 61000-6-2, EN 61000-6-3, EN 61000-3-11, EN 61000-3-12
Safety standard	IEC 62109-1/2, IEC 62116, IEC 61727, IEC 61683, IEC 60068(1,2,14,30), IEC 60255



Grid standard	AS/NZS 4777, VDE V 0124-100, V 0126-1-1, VDE-AR-N 4105, CEI 0-21/CEI 0-16, UNE 206 007-1, EN50549, G99, EN50530, NB/T32004
---------------	--

Note: the product may be upgraded in the future. The above parameters are for reference only. Please refer to the real product.

\* Only some certifications include SOFAR 70KTLX-G3, Please refer to the actual certified model.

---

---

# 10. Quality Assurance

## **SOFAR standard warranty document**

The standard warranty period of SOFARSOLAR's inverter is 60 months (5 years). There are two calculation methods for the warranty period:

- 1, Purchase invoice provided by the customer: SOFARSOLAR provides a standard warranty period of 60 months (5 years) from the invoice date;
- 2, The customer fails to provide the invoice: from the production date (according to the SN number of the machine). SOFARSOLAR provides a warranty period of 63 months (5.25 years).
- 3, Special warranty agreement shall be subject to purchase agreement.

## **Extended warranty period**

Within 12 months of the purchase of the inverter (based on the purchase invoice) or within 24 months of the production of the inverter(SN number of machine, based on the first date of arrival). Customers can apply to buy extended warranty products from the SOFARSOLAR's sales team by providing the product serial number. SOFARSOLAR has the right to reject the purchase application of the extended warranty period that does not meet the requirements. Customers can buy an extended warranty of 5, 10, 15 years.

If the customer wants to apply for the extended warranty service, please contact the sales team of SOFARSOLAR to purchase the products that are beyond the purchase period of extended warranty, but have not yet passed the standard quality warranty period. Customers shall bear different extended premium.

During the extended warranty period, PV components USB stick logger and lightning protection devices are not included in the extended warranty period. If they fail during the extended warranty period, customers need to purchase and replace them from SOFARSOLAR.

Once the extended warranty service is purchased, our company will issue the extended warranty card to the customer to confirm the extended warranty period.

### **Invalid warranty clause**

Equipment failure caused by the following reasons is not covered by the warranty:

- 1) The "warranty card" has not been sent to the distributor or our company;
- 2) Without the consent of our company to change equipment or replace parts;
- 3) Use unqualified materials to support our company 's products, resulting in product failure;
- 4) Technicians of non-company modify or attempt to repair and erase the product serial number or silk screen;
- 5) Incorrect installation, debugging and use methods;
- 6) Failure to comply with safety regulations (certification standards, etc.);
- 7) Damage caused by improper storage by dealers or end users;
- 8) Transportation damage (including scratches caused by internal packaging during transportation).Please claim directly from the transportation company or insurance company as soon as possible and obtain damage identification such as container/package unloading;
- 9) Failure to follow the product user manual, installation manual and maintenance guidelines;
- 10) Improper use or misuse of the device;
- 11) Poor ventilation of the device;
- 12) The product maintenance process does not follow relevant standards;
- 13) Failure or damage caused by natural disasters or other force (such as earthquake, lightning strike, fire, etc.)



---

Product Name: Solar Grid-tied Inverter

Company Name: Shenzhen SOFARSOLAR Co., Ltd.

ADD: 11/F., Gaoxingqi Technology Building, No.67 Area, Xingdong Community, Xin'an Sub-district,  
Bao'an District, Shenzhen City, China

Email: [service@sofarsolar.com](mailto:service@sofarsolar.com)

Tel: 0510-6690 2300

Web: [www.sofarsolar.com](http://www.sofarsolar.com)

