

Installation manual

denim

denimsolar.com

Contents

1. Introduction	1
2. Disclaimer of liability	1
3. Product Identification	1
4. Safety Precautions	2
4.1. Conventional Safety	2
4.2. Operating Safety	2
4.3. Installation Safety	3
4.4. Fire Safety	3
5. Mechanical Installation	4
5.1. Selection of installation site	4
5.2. Tilt Angle Selection	4
5.3. Regular requirements	4
5.4. Installation method	5
5.4.1. Installation by mounting holes	5
5.4.2. Installation by clamps	8
6. Electrical Installation	10
6.1. Electrical Performance	10
6.2. Cables and Wiring	11
6.3. Connectors	11
6.4. Bypass diodes	12
7. Grounding	12
7.1. Grounding by grounding bolt	12
7.2. Grounding by using grounding clamp	12
7.3. Addition Third-party Grounding Devices	12
8. Maintenance	12
8.1. Visual Inspection	12
8.2. Inspection of Connector and Cable	13
8.3. Cleaning	13

1. Introduction

Thank you for choosing Denim PV modules.

IMPORTANT SAFETY INSTRUCTION:

- All instruction should be read and understood before attempting to install. The installer should conform to all the safety precaution in the guide when installing the module. Local codes and regulations should also be followed in such installation.
- Installing solar systems requires specialized skills and knowledge. Installation should only be performed by professional and qualified personnel.

This installation manual includes essential electrical and mechanical installation information which you must be aware of before handling and installing the Photovoltaic Modules (hereinafter “Modules”) manufactured by Denim Solar B.V. (hereinafter “Denim”).

Safety:

- Keep this manual in a safe place for further reference (care and maintenance) and in case of sale or disposal of the module. If any questions, please contact Denim Customer Service Department (Email: support@solarclarity.nl) for further information.

2. Disclaimer of liability

Nothing in this manual constitute a warranty or guarantee from Denim, explicitly or implicitly. Denim is not responsible for any damage of any kind, including but not limited to any physical damage, injury or property loss resulting from or in connection with handling modules, system installation, or compliance or non-compliance with the instruction set forth in this manual.

Denim reserves the rights to modify this manual without notice in advance. It is recommended to visit our website regularly at www.denimsolar.com for the latest version of this installation manual. Failure of the customers to follow the requirements outlined in this installation manual will result in the invalidity of product's limited warranty provided by Denim.

3. Product Identification

Each module has two labels providing the following information.

- **Nameplate:** describes the product type; rated power, rated current, rated voltage, open circuit voltage, short circuit current, all as measured under standard test conditions; weight, dimensions, the maximum system voltage, etc.
- **Barcode:** each single module has a unique serial number. The serial number contains the model number, manufacturing time, and corresponding serial number of the module (except for customer designation).

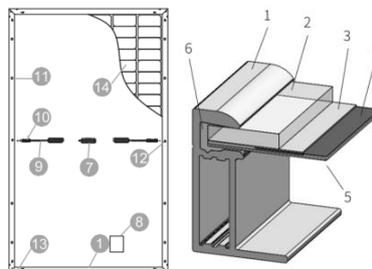

1.Aluminum	2.Glass	3.Encapsulating EVA	4.Cell	5.Backsheet
6.Silicone adhssive	7.Juntion Box	8.Lable	9.Cable	10.Connector
11.Mounting hole	12.Grounding hole	13.Drainage holes	14.Cell	

Figure 1 Schematic diagram of the structure of a single-sided module and description of the part

4. Safety Precautions

Denim Modules are designed to meet the requirements of IEC 61215 and IEC 61730, and its security level is in accordance with IEC 61730: Class II.

4.1. Conventional Safety

- Installing solar PV systems requires specialized skills and knowledge. Installation must only be performed by authorized and trained personnel. Installers must assume all risks of injury that might occur during installation, including, but not limited to, the risk of electric shock.
- A single module generates a direct current that can cause personal injury in the presence of direct sunlight. Contact with direct current has high potential risk, please avoid contact with direct current under any circumstances.
- PV modules are recommended to be installed at altitudes of less than 2000m.
- Modules can be ground mounted, mounted on rooftops. The proper design of support structures lies within the responsibility of the system designers and installers.
- When installing the system, abide to all local, regional and national statutory regulations. Obtain a building permit if necessary.
- Only use equipment, connectors, wiring and support frames suitable for solar electric systems. Always use fall protection equipment when working from heights of 6 feet (183cm) or above. Follow Occupational Safety and Health Act (OSHA) or local governing safety regulations regarding Fall Protection.
- Do not sit, stand, step on, or walk on modules, including the frames. Except for natural rainfall or periodic module cleaning, please do not soak any part of the module in water or continuously impact the module with water.

4.2. Operating Safety

- Do not open the package of Denim Solar Modules during transportation and storing until they are ready to be installed.
- Store pallets in a ventilated, rain-proof and dry location until the Modules are ready to be unpacked.
- During the transportation, do not apply direct pressure on the backsheet or glass.
- Inappropriate transport and installation may damage the module and void the warranty.
- Do not lift the module by holding the module's junction box or electrical leads. Do not place any heavy or sharp objects on the module.
- Do not attempt to disassemble the modules, and do not remove any attached nameplates or components from the modules.
- Do not use mirrors, other magnifiers or artificially concentrated sunlight onto the modules.



- Do not apply paint or adhesive to the module top surface or backsheet.
- To avoid damage to the backsheet and cells, do not scratch, dent or hit the backsheet.
- Do not drill holes in the frame. This may compromise the frame strength, cause corrosion of the frame and void the warranty.
- Do not scratch the anodized coating of the frame (except for grounding connections at the grounding connection point on the back side of the module). It may cause corrosion of the frame or compromise the frame strength.
- A module with broken glass or torn backsheet cannot be repaired and must not be used since contact with any module surface or the frame can cause an electric shock.

- Work only under dry conditions, and use only dry tools. Do not handle modules under wet conditions unless wearing appropriate protective equipment.
- When storing uninstalled modules outdoors for any period of time, always cover the modules and ensure that the glass faces down on a soft flat surface to prevent water from collecting inside the module and causing damage to exposed connectors.

4.3. Installation Safety

- Never disconnect electrical connections or unplug connectors while the circuit is under load.
- Contact with electrically active parts of the modules, such as terminals, can result in burns, sparks and lethal shock whether or not the module is connected.
- Do not touch the PV module unnecessarily during installation. The glass surface and the frame may be hot; there is a risk of burns and electric shock.
- Do not work in the rain, snow or in windy conditions.
- Avoid exposing cables and connectors to direct sunlight and scratches or cuts in order to prevent insulation degradation.
- Keep children well away from the system while transporting and installing mechanical and electrical components.
- Completely cover the module with an opaque material during installation to prevent electricity from being generated.



- Do not wear metallic rings, watchbands, ear, nose, lip rings or other metallic devices while installing or troubleshooting PV systems.
- Use only insulated tools that are approved for working on electrical installations.
- Follow the safety regulations (e.g., safety rules for working on electrical power plant stations) of your regions and for all other system components, including wires and cables, connectors, charging regulators, inverters, storage batteries, rechargeable batteries, etc.
- Under normal conditions, a PV module is likely to experience conditions that produce more current and/or voltage than reported at standard test conditions. Accordingly, the values of I_{sc} and V_{oc} marked on this module should be multiplied by a factor of 1.25 when determining component voltage ratings, conductor current ratings, minimum factor of fuse sizes, and size of controls connected to the PV output.
- Only use same connectors to connect modules to form a string, or connect to another device. Removing the connectors will void the warranty.
- It is strictly forbidden to touch wet module unless wearing anti electric shock equipment meeting the requirements. When cleaning modules, it is necessary to operate according to the requirements of this manual. The connector shall not contact with the following chemicals: gasoline, white flower oil, activating oil, mold temperature oil, engine oil, grease, lubricating oil, antirust oil, stamping oil, butter, diesel oil, edible oil, acetone, alcohol, Tianna water, release agent, adhesive and potting adhesive that can produce oxime gas, TBP, cleaning agent, etc.

4.4. Fire Safety

- Consult your local authority for guidelines and requirements for building or structural fire safety.
- According to UL 790 standard, Denim modules have been rated Fire Class C. When installing on the roof, the roof must be covered with a layer of fireproof material not lower than this level, and sufficient ventilation between the back of the module and the installation surface must be ensured.

- Roof construction and installation may affect the fire safety of the building, improper installation may create hazards in the event of a fire.
- Use appropriate components such as fuses, circuit breakers and grounding connectors as requires by local authority.
- Do not use modules near equipment or in locations where flammable gases may be generated or collected.

5. Mechanical Installation

5.1. Selection of installation site

- Modules can be mounted in landscape or portrait orientation.
- Do NOT install modules near flammable gas/vapors.
- Do NOT install modules in close proximity to air conditioning systems.
- Modules shall be installed in places free of shading to obtain the maximum yield of the PV system. The shading area may also increase the temperature of the shaded areas, resulting in power loss and a decrease of lifetime.
- Modules can be installed to withstand the extreme working temperature from -40°C to 85°C . Please ensure that installed modules do not suffer wind or snow pressure exceeding the permissible maximum load limit.
- Please do not install PV modules in a location where they'll be immersed in water or continually exposed to water from a sprinkler or fountain etc.
- Please ensure that lightning protection will be performed for modules installed in places with frequent lightning and thunder.
- Modules shall be installed on proper buildings or other appropriate places (such as ground, garage, building outer wall, roof, PV tracking system) but shall not be installed on any vehicles.
- Please carry out protective measures to ensure safe and reliable installation of modules in severe environment such as heavy snow, cold and strong wind or island close to water and salt mist or deserts.
- The modules should be installed more than 500 meters from the seaside. For exceptional installation within 50m-500m away from the seaside, stainless steel or aluminum material must be used in where contacting PV modules and the connection point shall be protected by anti-corrosion measurement. Installation less than 50m away from seaside is forbidden.

5.2. Tilt Angle Selection

- The tilt angle of the PV module is measured between the surface of the PV module and a horizontal ground surface. The PV module generates maximum output power when it faces the sun directly.
- For detailed information on the best elevation tilt angle for the installation, refer to standard solar photovoltaic installation guides or a reputable solar installer or systems integrator.
- Modules connected in series shall be installed with same orientation and tilt angle. If difference occurs, it may result in different solar irradiation and output power loss.
- Dust building up on the surface of the modules can impair module performance. A minimum tilt angle 10 degree is suggested so that dust on the surface can be washed away more easily by rain.

5.3. Regular requirements

- Please ensure installation method and supporting system of modules are strong enough to allow the module to withstand the predetermined load conditions. Please use a supporting structure approved by testing and certification.
- The module mounting structure must be made of durable, corrosion-resistant and UV-resistant material.
- The bracket beam shall not be installed directly below the junction box.
- In regions with heavy snowfall in winter, select the height of the mounting system so that the lowest edge of the module is not covered by snow for any length of time. In addition, ensure that the lowest portion of the module is placed high enough so that it is not shaded by plants, trees or damaged by ground soil moved by or through the air.
- Provide adequate ventilation under the modules in conformity to your local regulations. It is recommended that the

minimum distance between the roof plane and the module is not less than 10 cm.

- Avoid the frame receiving the lateral tension and pressure, causing the frame off or crushing the glass.
- The recommended minimum gap between two adjoining modules frame is 1cm because the linear thermal expansion of the modules frame need to be take into account.
- Always keep the module backsheet free from foreign objects or structural elements, which could come into contact with the panel, especially when the panel is under mechanical load.
- Modules have been certified for a maximum static load 5400 Pa on the front (snow load) and 2400 Pa on the back (wind load), these values can vary depending on installation method of the modules (please refer to following installation guide), the described load in this manual is for the test load. Note: According to IEC 61215-2016 installation requirements, the safety factor of 1.5 times needs to be taken into consideration when computing the relevant maximum design load.

5.4. Installation method

Denim modules can be installed with mounting holes or clamps. Ideally placed to optimize the load handling capability, to secure the modules to supporting structure.

5.4.1. Installation by mounting holes

In order to extend the life of module support, Denim strongly advises to use anti-corrosion (stainless steel) attachment hardware. The torque during tightening is recommended to be maintained at 16-20 N·m. The method and the specifications of the fixing parts are shown in Figure2 below:

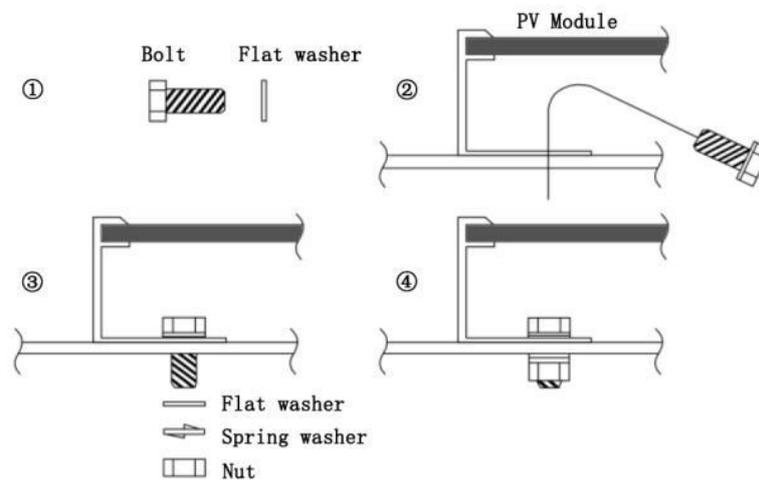
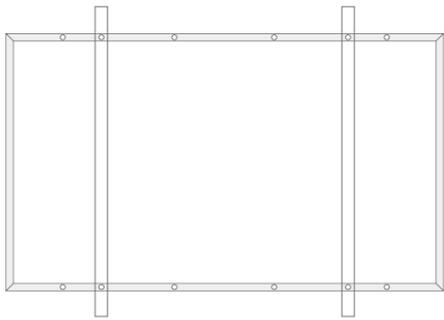

Figure 2 Mounting Details

Bolt	Flat Washer
Material: stainless steel size:M8*20mm	Material: stainless steel size:M8 thickness:≥1.6mm
Spring Washer	Nut
Material: stainless steel size:M8 thickness:≥2.0mm	Material: stainless steel size:M8

Detailed installation positions and corresponding load capacities are shown below:

Mounting by inner four holes



Beam perpendicular to long sides

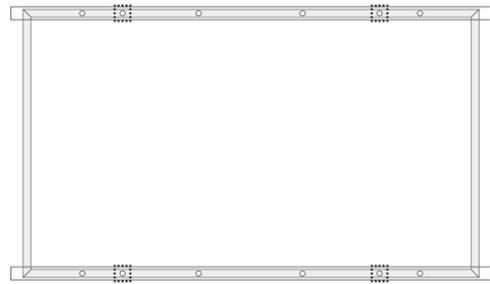

Beam parallel to long sides

Mounting by outer four holes

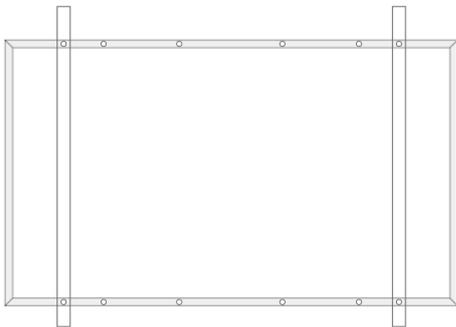

Beam perpendicular to long sides

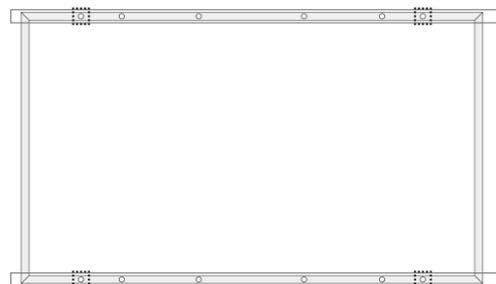

Beam parallel to long sides

Mounting by eight holes

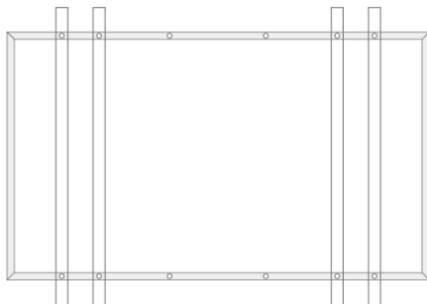

Beam perpendicular to long sides

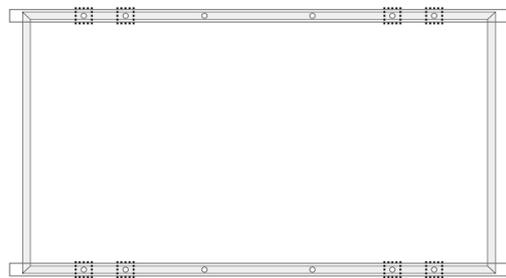

Beam parallel to long sides

Mounting by 400mm spaced holes

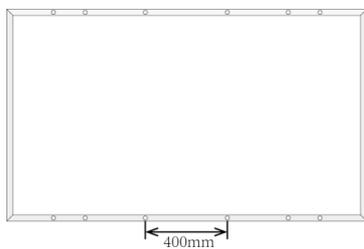

For single-axis tracking system

Figure 3 Installation Positions

Module types	Installation methods	Inner four holes	Outer four holes	Mounting by eight holes	Mounting by 400mm spaced holes
Denim U M2 XXX BB 120H		+2400/-1800	+2400/-1800	+5400/-2400	/
Denim U M2 XXX BW 120H		+2400/-1800	+2400/-1800	+5400/-2400	/
Denim U M2 XXX WW 120H		+2400/-1800	+2400/-1800	+5400/-2400	/
Denim U M2 XXX BB 132H		+2400/-1800	+2400/-1800	+5400/-2400	±1800
Denim U M2 XXX BW 132H		+2400/-1800	+2400/-1800	+5400/-2400	±1800
Denim U M2 XXX WW 132H		+2400/-1800	+2400/-1800	+5400/-2400	±1800
Denim U M2 XXX BB 144H		+2400/-1800	+2400/-1800	+5400/-2400	±1800
Denim U M2 XXX BW 144H		+2400/-1800	+2400/-1800	+5400/-2400	±1800
Denim U M2 XXX WW 144H		+2400/-1800	+2400/-1800	+5400/-2400	±1800
Denim U M3 XXX BB 108H		+2400/-1800	+2400/-1800	+5400/-2400	/
Denim U M3 XXX BW 108H		+2400/-1800	+2400/-1800	+5400/-2400	/
Denim U M3 XXX WW 108H		+2400/-1800	+2400/-1800	+5400/-2400	/
Denim U M3 XXX BB 120H		+2400/-1800	+2400/-1800	+5400/-2400	/
Denim U M3 XXX BW 120H		+2400/-1800	+2400/-1800	+5400/-2400	/
Denim U M3 XXX WW 120H		+2400/-1800	+2400/-1800	+5400/-2400	/
Denim U M3 XXX BB 132H		+2400/-1800	+2400/-1800	+5400/-2400	±1800
Denim U M3 XXX BW 132H		+2400/-1800	+2400/-1800	+5400/-2400	±1800
Denim U M3 XXX WW 132H		+2400/-1800	+2400/-1800	+5400/-2400	±1800
Denim U M3 XXX BB 144H		+2400/-1800	+2400/-1800	+5400/-2400	±1800
Denim U M3 XXX BW 144H		+2400/-1800	+2400/-1800	+5400/-2400	±1800
Denim U M3 XXX WW 144H		+2400/-1800	+2400/-1800	+5400/-2400	±1800
Denim U M3 XXX BB 156H		+2400/-1800	+2400/-1800	+5400/-2400	±1800
Denim U M3 XXX BW 156H		+2400/-1800	+2400/-1800	+5400/-2400	±1800
Denim U M3 XXX WW 156H		+2400/-1800	+2400/-1800	+5400/-2400	±1800
Denim U N3 XXX BB 108H		+2400/-1800	+2400/-1800	+5400/-2400	/
Denim U N3 XXX BW 108H		+2400/-1800	+2400/-1800	+5400/-2400	/
Denim U N3 XXX WW 108H		+2400/-1800	+2400/-1800	+5400/-2400	/
Denim U N3 XXX BB 120H		+2400/-1800	+2400/-1800	+5400/-2400	/
Denim U N3 XXX BW 120H		+2400/-1800	+2400/-1800	+5400/-2400	/
Denim U N3 XXX WW 120H		+2400/-1800	+2400/-1800	+5400/-2400	/
Denim U N3 XXX BB 132H		+2400/-1800	+2400/-1800	+5400/-2400	±1800
Denim U N3 XXX BW 132H		+2400/-1800	+2400/-1800	+5400/-2400	±1800
Denim U N3 XXX WW 132H		+2400/-1800	+2400/-1800	+5400/-2400	±1800
Denim U N3 XXX BB 144H		+2400/-1800	+2400/-1800	+5400/-2400	±1800
Denim U N3 XXX BW 144H		+2400/-1800	+2400/-1800	+5400/-2400	±1800
Denim U N3 XXX WW 144H		+2400/-1800	+2400/-1800	+5400/-2400	±1800

5.4.2. Installation by clamps

- When choosing this type of clamp-mounting method, each module needs 4 clamps at least. Depending on local weather, such as wind and snow condition, additional clamps may be required to ensure that modules have enough support. The minimum recommended length for each fixture shall be 50mm and the applied torque shall be determined according to the mechanical design standards of the bolts used by the customer, e.g.: M8 ---- 18-24N·m.
- The clamp must overlap the module frame by at least 7mm but no more than 10mm. Modules clamps should not come into contact with the front glass and must not deform the frame. Be sure to avoid shadowing effects from the module clamps. The mounting details are shown in Figure 4.

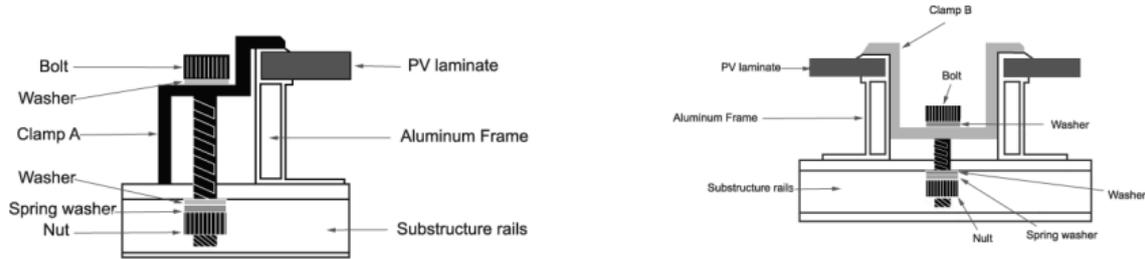
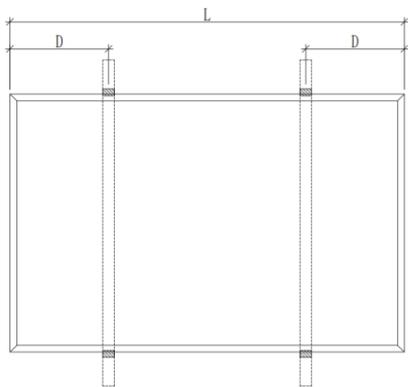
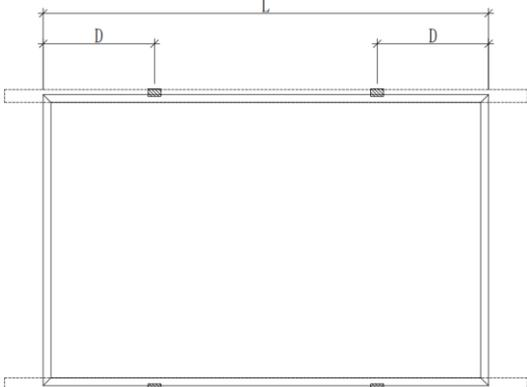
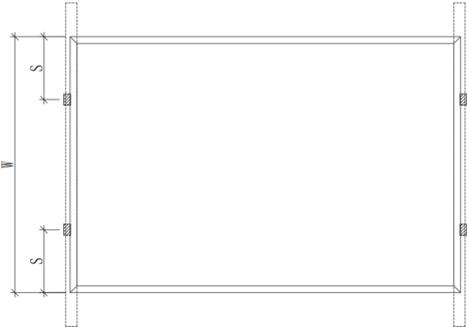
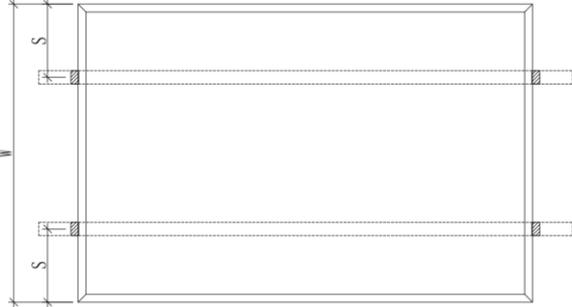
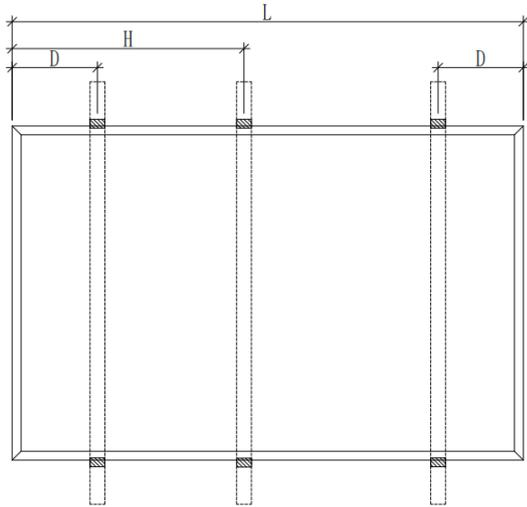

Figure 4 Clamp Details

Detailed installation positions and corresponding load capacities are shown in the table below.

Mounting by 4 clamps of long side	
 <p>Beam perpendicular to long sides (The black shadow is the clamp center range, clamp length\geq60mm)</p>	 <p>Beam parallel to long sides (The black shadow is the clamp center range, clamp length\geq60mm)</p>
Mounting by 4 clamps of short side	
 <p>Beam perpendicular to long sides (The black shadow is the clamp center range, clamp length\geq50mm)</p>	 <p>Beam parallel to long sides (The black shadow is the clamp center range, clamp length\geq50mm)</p>

Mounting by 6 clamps of long side



Beam perpendicular to long sides
(The black shadow is the clamp center range, clamp length \geq 50mm)

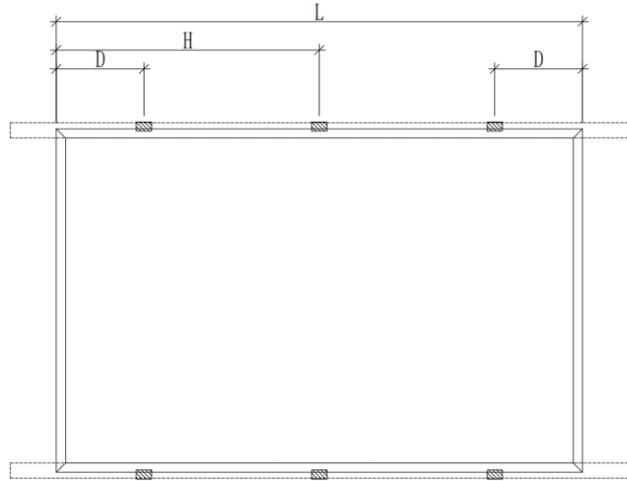

Beam parallel to long sides
(The black shadow is the clamp center range, clamp length \geq 50mm)

Figure 5 Installation Positions

Installation methods Module types	use 4 clamps of long side			use 4 clamps of short side	use 6 clamps of long side
	$\frac{1}{8}L-70 \leq D \leq \frac{1}{4}L+70$	$\frac{1}{4}L-50 \leq D \leq \frac{1}{4}L+50$	$\frac{1}{5}L-50 \leq D \leq \frac{1}{5}L+50$	$0 \leq S \leq \frac{1}{4}W$	$\frac{1}{6}L-50 \leq D \leq \frac{1}{6}L+50$ $\frac{1}{2}L-80 \leq H \leq \frac{1}{2}L-30$
Denim U M2 XXX BB 120H	/	+5400/-2400	/	± 2400	/
Denim U M2 XXX BW 120H	/	+5400/-2400	/	± 2400	/
Denim U M2 XXX WW 120H	/	+5400/-2400	/	± 2400	/
Denim U M2 XXX BB 132H	/	+5400/-2400	/	± 2400	/
Denim U M2 XXX BW 132H	/	+5400/-2400	/	± 2400	/
Denim U M2 XXX WW 132H	/	+5400/-2400	/	± 2400	/
Denim U M2 XXX BB 144H	/	/	/	/	+5400/-2400
Denim U M2 XXX BW 144H	/	/	/	/	+5400/-2400
Denim U M2 XXX WW 144H	/	/	/	/	+5400/-2400
Denim U M3 XXX BB 108H	± 1600	+5400/-2400	/	± 2400	/
Denim U M3 XXX BW 108H	± 1600	+5400/-2400	/	± 2400	/
Denim U M3 XXX WW 108H	± 1600	+5400/-2400	/	± 2400	/
Denim U M3 XXX BB 120H	± 1600	+5400/-2400	/	± 2400	/
Denim U M3 XXX BW 120H	± 1600	+5400/-2400	/	± 2400	/
Denim U M3 XXX WW 120H	± 1600	+5400/-2400	/	± 2400	/

Denim U M3 XXX BB 132H	/	/	+3600/-2400	/	+5400/-2400
Denim U M3 XXX BW 132H	/	/	+3600/-2400	/	+5400/-2400
Denim U M3 XXX WW 132H	/	/	+3600/-2400	/	+5400/-2400
Denim U M3 XXX BB 144H	/	/	+3600/-2400	/	+5400/-2400
Denim U M3 XXX BW 144H	/	/	+3600/-2400	/	+5400/-2400
Denim U M3 XXX WW 144H	/	/	+3600/-2400	/	+5400/-2400
Denim U M3 XXX BB 156H	/	/	+3600/-2400	/	+5400/-2400
Denim U M3 XXX BW 156H	/	/	+3600/-2400	/	+5400/-2400
Denim U M3 XXX WW 156H	/	/	+3600/-2400	/	+5400/-2400
Denim U N3 XXX BB 108H	±1600	+5400/-2400	/	±2400	/
Denim U N3 XXX BW 108H	±1600	+5400/-2400	/	±2400	/
Denim U N3 XXX WW 108H	±1600	+5400/-2400	/	±2400	/
Denim U N3 XXX BB 120H	±1600	+5400/-2400	/	±2400	/
Denim U N3 XXX BW 120H	±1600	+5400/-2400	/	±2400	/
Denim U N3 XXX WW 120H	±1600	+5400/-2400	/	±2400	/
Denim U N3 XXX BB 132H	/	/	+3600/-2400	/	+5400/-2400
Denim U N3 XXX BW 132H	/	/	+3600/-2400	/	+5400/-2400
Denim U N3 XXX WW 132H	/	/	+3600/-2400	/	+5400/-2400
Denim U N3 XXX BB 144H	/	/	+3600/-2400	/	+5400/-2400
Denim U N3 XXX BW 144H	/	/	+3600/-2400	/	+5400/-2400
Denim U N3 XXX WW 144H	/	/	+3600/-2400	/	+5400/-2400

6. Electrical Installation

6.1. Electrical Performance

- Module electric performance parameters such as I_{sc} , V_{oc} have $\pm 5\%$ tolerance, P_{max} nominal value has $\pm 3\%$ tolerance under standard testing conditions of: irradiance of 1000 W/m^2 , cell temperature of 25°C and air mass of AM1.5. Under normal conditions, the modules may produce more current or voltage than reported at Standard Test Conditions. Accordingly, the values of short circuit current & open circuit voltage marked on modules shall be multiplied by a factor of 1.25 when determining component voltage ratings, conductor capacities, fusing sizes, and size of controls connected to modules output.
- When modules are connected in series, the final voltage is sum of the single module. When modules are connected in parallel, the final current is sum of the single module, as shown in Figure 6. Modules with different electric performance models cannot be connected in series.

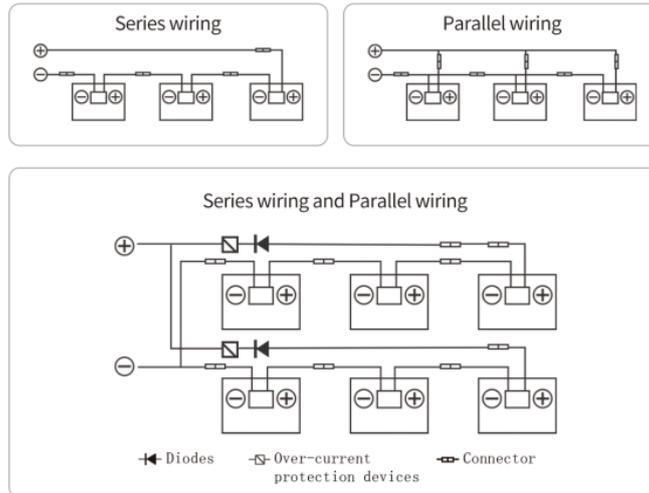

Figure 6 Electrical diagrams of series and parallel wiring

- The maximum number of modules that can be connected in one series string shall be calculated in comply with relevant regulations. The open circuit voltage value under the expected lowest temperature shall not exceed the maximum system voltage value stipulated for modules and other values required by DC electric parts. The maximum system voltage of Denim modules is DC 1000V/ 1500V based on IEC61730.

The maximum number of the modules can be installed in one series string can be calculated as below:

$$N = \frac{V_{MAX}}{V_{oc}[1 - \beta \times (25 - T)]}$$

N: The maximum number of modules in series;

V_{MAX}: Maximum system voltage;

V_{oc}: Open circuit voltage of single module;

β: Temperature coefficient of Voc of the selected module;

T: The expected lowest temperature of the installation site.

- Please use over-current protection device with the same specifications to protect the modules, if reverse current could exceed the value of the maximum fuse rating of the modules as shown in datasheet. An over-current protection device is required if more than two strings are connected in parallel.

6.2. Cables and Wiring

- To prevent the cables and the connectors from overheating, the cross section of the cables and the capacity of the connectors must be selected to suit the maximum system short circuit current. The recommended cable is PV wire with a cross section of at least 4mm².
- The cables cannot be secured too tight. Any cable damage caused by cable management system is not covered under DENIM's warranty.
- Please refer to local regulations to determine the system wires size, type and temperature.

6.3. Connectors

- Denim modules are supplied with connectors used for system electrical connections. We strongly recommend using the genuine connector type specified by Denim's product data sheet.
- To ensure reliable electric connection and to prevent possible intrusion of humidity, two connectors must be mated and locked together until a click can be heard.
- Connector connections should be kept dry and clean to prevent rain and moisture. Protect the connector from direct sunlight and water immersion.
- The connector does not have any waterproof function before docking, and the modules need to be docked as quickly as possible or take waterproof measures to avoid the connector from contacting moisture and dust.

6.4. Bypass diodes

Junction boxes of Denim Modules contain bypass diodes wired in parallel with the PV cell strings. If hot spot occurs with the module, the bypass diodes start to work to prevent main current from flowing through the hot spot cells, so that module heating and power loss could be limited. Please notice that bypass diodes are not over-current protection devices. If the diodes are found to be out of function, installers or maintenance providers should contact Denim. Please do not try to open the junction box by yourself.

7. Grounding

Denim PV Modules use an anodic oxidized aluminum frame to resist corrosion, so the frame of Modules should be connected to the equipment grounding conductor to prevent thunder and electrical shock. The grounding device should fully contact the aluminum alloy and should penetrate the oxide film on the surface of the frame.

Holes marked with a grounding mark on the frame can only be used for grounding but not for mounting.

The grounding conductor or strap may be copper, copper alloy, or other material acceptable for use as an electrical conductor in accordance with National Electrical Codes. The grounding conductor must then connect to earth using a suitable earth ground electrode.

Denim recommends one of the following parts for grounding:

7.1. Grounding by grounding bolt

Mounting holes on modules that are not occupied can be used for installing grounding components.

- Align grounding clamp to the frame mounting hole. Use grounding bolt to bond the grounding clamp and frame.
- Put the tooth side of the washer on the other side and fasten the nuts.
- Put grounding wires through the grounding clamp and grounding wire material and dimension shall meet requirements in local national and regional law and regulations.
- Fasten bolts of grounding wires and then installation is completed.

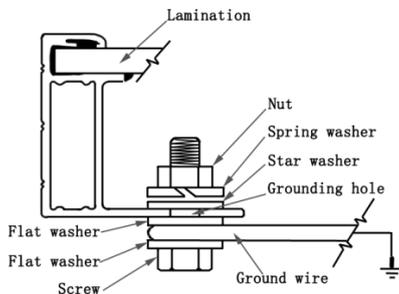

Figure 7 Bolt grounding mode

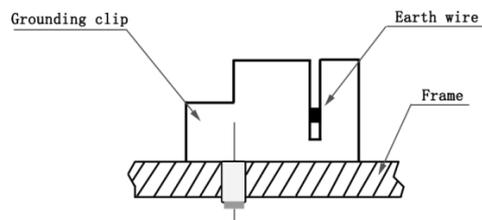

Figure 8 Clamp grounding mode

7.2. Grounding by using grounding clamp

The grounding clip assembly consists of a slider, base, and self-captivating thread-cutting screw or 8-32 screw and hex nut, as shown in the Figure 8. The grounding clip accepts solid uninsulated copper wire sizes 10 or 12 AWG.

7.3. Addition Third-party Grounding Devices

Denim PV Modules can be grounded using third party grounding devices so long as they are certified for grounding modules and the devices are installed according to the manufacturer's specified instructions.

8. Maintenance

It is required to perform regular inspection and maintenance of the modules, especially during the warranty period.

8.1. Visual Inspection

Inspect the modules visually to find if there are any visual defects, if there are, the following items should be evaluated:

- If modules are observed having slight cell color differences at different angles, this is a normal phenomenon of modules with anti-reflection coating technology.

- Whether the glass is broken.
- No sharp objects are in contact with the PV module surfaces.
- PV modules are not shaded by unwanted obstacles and; or foreign material.
- Corrosion along the cells' bus-bar.
- Whether the back sheet is burn out.
- Check if screws and mounting brackets are tight, adjust and tighten as necessary.

8.2. Inspection of Connector and Cable

It's recommended to implement the following preventive maintenance every six months:

- Check the sealing gels of the junction box for any damage.
- Check the tightness of the connector, whether the cable connector is firm, and whether the modules are well grounded.

8.3. Cleaning

- Clean the glass surface of the module as necessary. Always use water and a soft sponge or cloth for cleaning.
- A mild, nonabrasive cleaning agent can be used to remove stubborn dirt.
- In order to reduce the potential for electrical and thermal shock, Denim recommends cleaning PV modules during early morning or late afternoon hours when solar radiation is low and the modules are cooler, especially in regions with hotter temperatures.
- Never attempt to clean a PV module with broken glass or other signs of exposed wiring, as this presents a shock hazard.
- Never use chemicals when cleaning modules as this may affect the module warranty and energy output.

denim

Denim Solar B.V.



www.denimsolar.com



info@denimsolar.com

V.Jul-2023-1

All Rights Reserved